

# Block feeder SPVS

Used in oil or grease lubrication systems



Block feeders of the SPVS series are used in grease and oil total loss lubrication systems. They are used to either increase the number of outlets of a lubricating pump

or to portion the volume flow and deliver it to the lube points, without any influence on the operating system pressure.

Fields of application are, for example, metal-forming machines, diesel engines and packaging machines.

## Advantages

- Very compact design
- Robust and good value
- Universally usable for grease and oil
- Central function monitoring with electrical stroke monitoring device possible

- Defined volume portion per cycle and outlet of:
  - 0,32 cm<sup>3</sup> with SPVS25
  - 0,16 cm<sup>3</sup> with SPVS1
- Accurate lubricant distribution, even with back pressure at the lubrication points, due to fitted pistons.

- The feeders are available with either 2 or 4 outlets
- Available in metric or inch and steel or brass design

# Block feeder SPVS, basic design

for oil or grease, without attachments

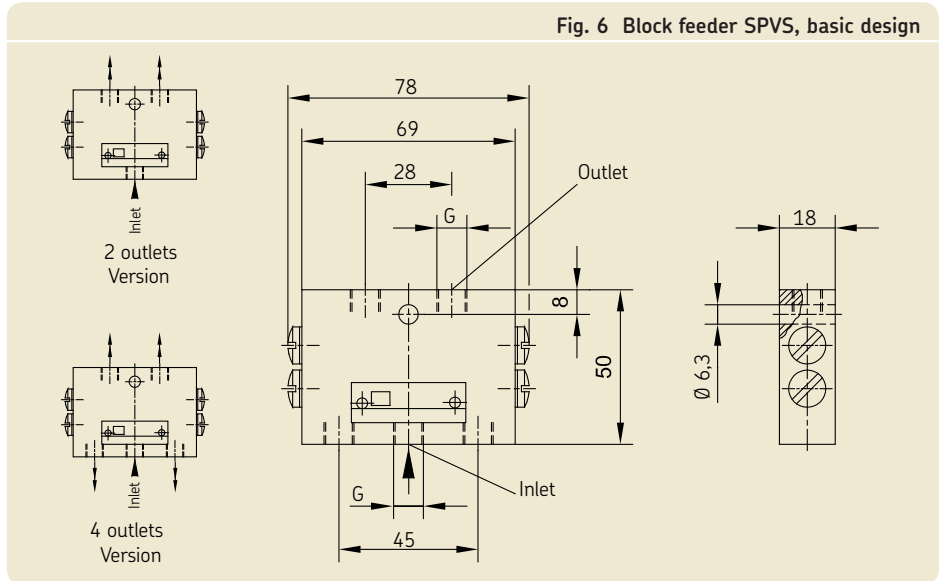
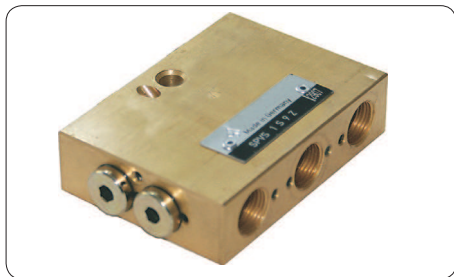

**Note!**  
 Oil and grease of different viscosity or penetration can be used.  
 Their operating limits concerning volume flow and pipe diameter, have to be taken into consideration. Inlet and outlet couplings (see page 5) have to be ordered separately.

Technical data	
Style	hydraulically controlled
Mounting position	discretionary
Quantity of outlets	2, 4
Screw connection	I/O: M12x1 or G1/8"
Housing material	with M12x1 = CuZn, with G1/8" = St
Ambient temperature range	-10 to +100 °C
<b>Hydraulic</b>	
Operating pressure max.:	100 bar
Lubricant temperature range	-10 to +100 °C
Max. permissible pressure difference	
of any two outlets	oil 20 bar, grease 30 bar
Max volume flow inlet	45 cm <sup>3</sup> /min
Volume per outlet and cycle	0,32 cm <sup>3</sup> at SPVS25
	0,16 cm <sup>3</sup> at SPVS1
Lubricant	Mineral oils, greases based on mineral oil, environmentally friendly and synthetic oils and greases
Operating viscosity	> 12 mm <sup>2</sup> /s
Worked penetration	≥ 265 × 0.1 mm (up to NLGI grade 2)

SPVS Basic design					
Outlets	Thread	monitoring switch	Wight [kg]	Order code	Order no.
2	G 1/8	without	0.45	SPVS25-2-ST-G1/8Z	44-2578-6321
4	G 1/8	without	0.45	SPVS1-4-ST-G1/8Z	44-2578-6323
2	M 12x1	without	0.46	SPVS25S1Z-2-MS-M12x1	44-2578-6110
4	M 12x1	without	0.46	SPVS1S9Z-4-MS-M12x1	44-2578-6201

# Block feeder SPVS with monitoring switch for oil und grease



Fig. 7 Block feeder SPVS with monitoring switch

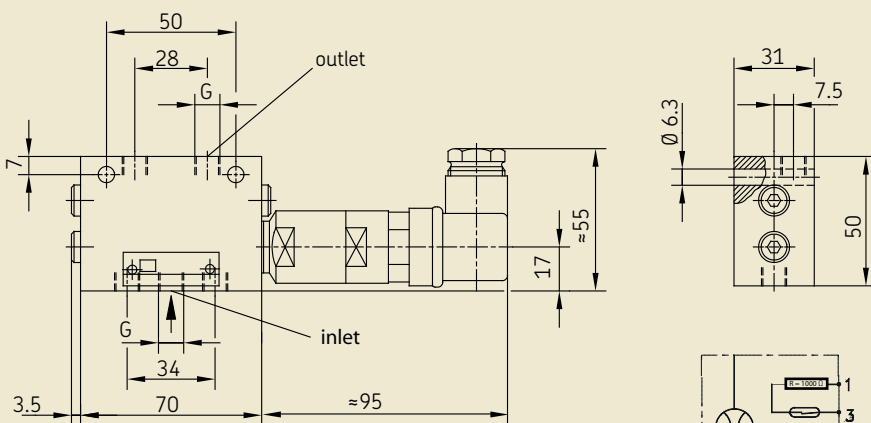

### Technical data

#### Block feeder SPVS

For further technical data, see "SPVS Basic Design", page 3  
 Thread connection . . . . . Inlet/outlet: G1/8"  
 Housing material . . . . . GGC 25

#### Electric

Ambient and lubricant temperature range . . . . . -15 to +70 °C  
 one electrical impuls (Cycus) . . . . . to correspond to 0,64 cm<sup>3</sup>  
 Electrical connection . . . . . Plug / DIN 43650  
 Rated voltage U<sub>r</sub> . . . . . 30 V  
 load current I<sub>i</sub> . . . . . 0,02 A  
 Output function . . . . . NO (normaly open)  
 Switching element/contact type . . . . . reed contact  
 Type of protection . . . . . IP 65 <sup>1)</sup>

1) Available in ATEX design, on demand.

### SPVS with monitoring switch

Outlets	Thread	Monitoring switch	Wight [kg]	Order code	Order no.
2	G 1/8	electrical	0.60	SPVS25-2-A-G1/8Z	44-2578-6360
4	G 1/8	electrical	0.65	SPVS1-4-A-G1/8Z	44-2578-6350

## Accessories for Block feeder SPVS

		Accessories
Inlet couplings for feeders with connecting threads M12x1		Order no.
Pipe ø 4,	Conical nipple Socket union	44-0405-6532 44-0159-7101
Pipe ø 6,	Conical nipple Socket union	44-0405-6531 44-0159-7102
Pipe ø 8,	Inlet coupling	24-0159-6010
Pipe ø 10,	Screwed coupling	24-0159-6011
for feeder with connecting threads R1/8"		Order no.
Pipe ø 4,	Conical nipple Socket union Straight coupling 4_LLRL Elbow coupling WE 4_LLRL Swivelling screw fitting SWVE 4-LLRL	44-0405-2003 44-0709-2040 404-403W 404-405W 96-7004-0058
Pipe ø 6,	Conical nipple Socket union Straight coupling GE 6_LLRL Elbow coupling WE 6_LLRL Swivelling screw fitting SWVE 6-LLRL	406-001 44-0709-2041 406-423W 96-6106-0058 96-7006-0058
Pipe ø 8,	Straight coupling GE 8_LLRL Elbow coupling WE 8_LLRL Swivelling screw fitting SWVE 8-LLRL	408-423W 96-6108-0058 96-7008-0058

## Overview progressive feeders

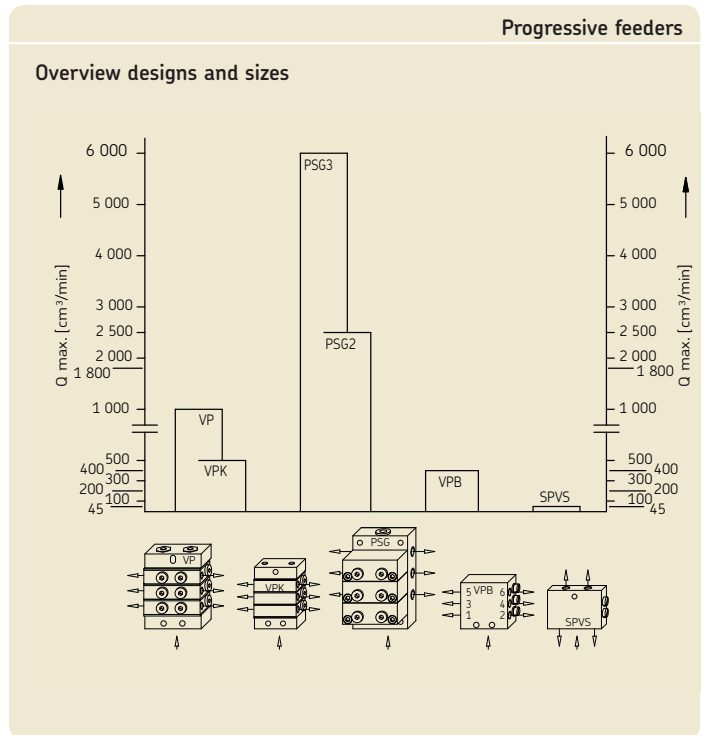

## How they operate

The lubricant delivered by the pump passes through the inlet port into the feeder and flows through the light-colored ducts into the individual outlet chambers

The piston presses the lubricant out of the respective outlet chamber through the dark colored ducts to the individual outlet ports.

### Figure 1

The lubricant flows to the upper left outlet chamber and shoves the piston to the right. As a result, the lubricant is pressed out of the upper right outlet chamber to outlet port 4, and the balls are displaced in such a way that they block the lower piston.

### Figure 2

The lubricant flows to the lower left outlet chamber and shoves the piston to the right. As a result, the lubricant is pressed out of the lower right outlet chamber to outlet port 1, and the balls are displaced in such a way that they block the upper piston.

### Figure 3

The lubricant flows to the upper right outlet chamber and shoves the piston to the left. As a result, the lubricant is pressed out of the upper left outlet chamber to outlet port 3, and the balls are displaced in such a way that they block the lower piston.

### Figure 4

The lubricant flows to the lower right outlet chamber and shoves the piston to the left. As a result, the lubricant is pressed out of the lower left outlet chamber to outlet port 2, and the balls are displaced in such a way that they block the upper piston (cf.Fig.5).

This sequence is constantly repeated on a forced basis (progressive).

The advantage of sequential phase control is that if just one single outlet port is closed, the entire feeder is blocked.

### Figure 5

The upper piston is held fast by the two balls until the lower piston has reach its end position on the left. As a result, a forced and uniform apportionment of the delivered lubricant is achieved.

Please note: In the case of feeders with two outlet ports, ports 1 and 3 as well as 2 and 4 are internally combined; only ports 1 and 2 are effective.

The mode of operation is identical for feeders with 2 or 4 outlet ports.

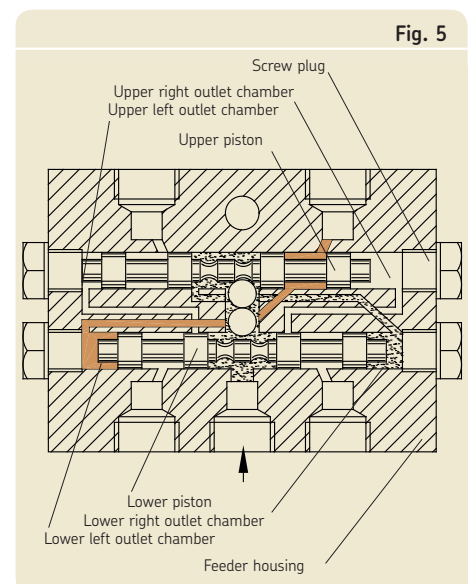
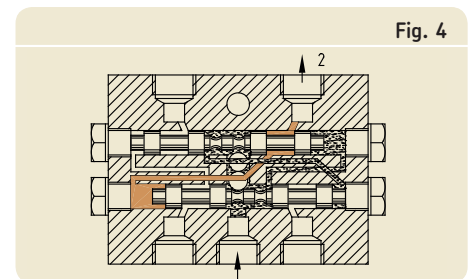
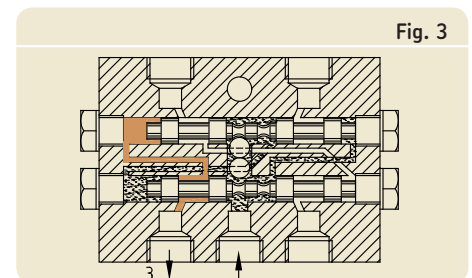
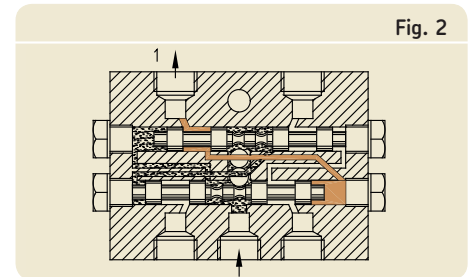
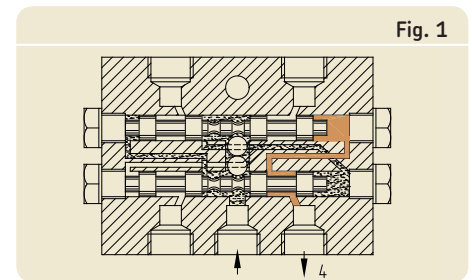

See important product usage information on the back cover.





**Order No. 1-3029-EN**

Subject to change without notice! (12/2014)

**Important product usage information**

All products from SKF may be used only for their intended purpose as described in this brochure and in any instructions. If operating instructions are supplied with the products, they must be read and followed.

Not all lubricants are suitable for use in centralized lubrication systems. SKF does offer an inspection service to test customer supplied lubricant to determine if it can be used in a centralized system. SKF lubrication systems or their components are not approved for use with gases, liquefied gases, pressurized gases in solution and fluids with a vapor pressure exceeding normal atmospheric pressure (1013 mbars) by more than 0.5 bar at their maximum permissible temperature.

Hazardous materials of any kind, especially the materials classified as hazardous by European Community Directive EC 67/548/EEC, Article 2, Par. 2, may only be used to fill SKF centralized lubrication systems and components and delivered and/or distributed with the same after consulting with and receiving written approval from SKF.

**Brochure note**

- 1-3013-EN Progressive modular feeder PSG 2
- 1-3014-EN Progressive modular feeder PSG 3
- 1-3015-EN Progressive sectional feeder VPK
- 1-3016-EN Progressive sectional feeder VP
- 1-3017-EN Progressive block feeder VPB
- 1-3029-EN Progressive block feeder SPVS

**SKF Lubrication Systems Germany GmbH**

2. Industriestrasse 4 · 68766 Hockenheim · Germany  
Tel. +49 (0)62 05 27-0 · Fax +49 (0)62 05 27-101  
[www.skf.com/lubrication](http://www.skf.com/lubrication)

This brochure was presented by:

® SKF is a registered trademark of the SKF Group.

© SKF Group 2014

The contents of this publication are the copyright of the publisher and may not be reproduced (even extracts) unless prior written permission is granted. Every care has been taken to ensure the accuracy of the information contained in this publication but no liability can be accepted for any loss or damage whether direct, indirect or consequential arising out of the use of the information contained herein.

