

SKF bearing housings and roller bearing units



SKF mobile apps

SKF mobile apps are available from both Apple App Store and Google Play. These apps provide useful information and allow you to make critical calculations, providing SKF Knowledge Engineering at your fingertips.

Register your catalogue

You can get updates for this catalogue via email if you register at skf.com/catalogues.

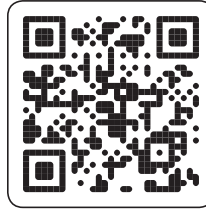

Apple App Store

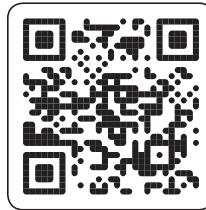

Google Play

© SKF, CARB, KMT, KMTA, SKF SYSTEM 24 are registered trademarks of the SKF Group.

™ SKF Explorer is a trademark of the SKF Group.

Android is a trademark of Google Inc.

Apple is a registered trademark of Apple Inc.

Superbolt® is a registered trademark of the Nord-Lock Group.

EPD® is a registered trademark of AB Svenska Miljöstyrringsrådet.

© SKF Group 2012

The contents of this catalogue are the copyright of the publisher and may not be reproduced (even extracts) unless permission is granted. Every care has been taken to ensure the accuracy of the information contained in this catalogue but no liability can be accepted for any loss or damage whether direct, indirect or consequential arising out of the use of the information contained herein.

PUB BU/P1 13186 EN · October 2012

This catalogue supersedes publication number 4005 EN.

Certain image(s) used under license from Shutterstock.com

SKF bearing housings and roller bearing units



SKF bearing housings and roller bearing units

Unit conversions	10
Foreword	11
This is SKF	16
SKF – the knowledge engineering company	18
1 SKF bearing housings – overview, selection and application recommendations ..	21
Basics	22
Terminology	22
Overview of SKF bearing housings	27
Assortment	27
Housing materials	29
Selecting a housing	35
Environmental conditions	36
Custom painting / corrosivity category	36
Sealing solutions	36
The SKF three-barrier solution	39
Design considerations	40
Bearing systems	40
Load carrying ability	44
Specifications for shafts and housing support surfaces	45
Lubrication	46
Grease selection	46
Initial grease fill	46
Relubrication	46
SKF tools and products	47
Mounting	50
Preparations prior to mounting	50
SKF tools and products	50
Lifting housings	50
Attachment bolt tightening	50
Using shims	50
Using locating (stabilizing) rings	50
Installing seals	51
Inspection and condition monitoring	52
Storage	52

2	Split plummer block housings – SNL 2, 3, 5 and 6 series	55
	Designations	57
	Standard housing design	59
	Housing variants	62
	Sealing solutions	64
	Using sealed bearings	68
	Special seals	70
	Design considerations	72
	Lubrication	78
	Mounting	82
	Condition monitoring	83
	Accessories	84
	Ordering information	84
	Product tables	
2.1	SNL plummer block housings for bearings on an adapter sleeve, metric shafts	86
2.2	SNL plummer block housings for bearings on an adapter sleeve, inch shafts	100
2.3	SNL plummer block housings for bearings on a cylindrical seat	120
3	Split plummer block housings – SE 2, 3, 5 and 6 series	139
	Designations	141
	Standard housing design	143
	Product data	148
	Ordering information	149
4	Split plummer block housings – SNLN 30 series	151
	Designations	153
	Standard housing design	155
	Housing variants	158
	Sealing solutions	160
	Using sealed bearings	164
	Special seals	166
	Design considerations	168
	Lubrication	173
	Mounting	177
	Condition monitoring	178
	Accessories	178
	Ordering information	179
	Product tables	
4.1	SNLN 30 plummer block housings for bearings on an adapter sleeve	180
4.2	SNLN 30 plummer block housings for bearings on a cylindrical seat	184

5	Split plummer block housings – SNL 30, 31 and 32 series	189
	Designations	191
	Standard housing design	193
	Housing variants	196
	Sealing solutions	196
	Using sealed bearings	200
	Special seals	200
	Design considerations	203
	Lubrication	212
	Mounting	219
	Condition monitoring	220
	Accessories	221
	Ordering information	221
	Product tables	
5.1	Large SNL plummer block housings for bearings on an adapter sleeve, metric shafts	222
5.2	Large SNL plummer block housings for bearings on an adapter sleeve, inch shafts	260
5.3	Large SNL plummer block housings for bearings on a cylindrical seat	301
6	Split plummer block housings – SED 30, 31, 32 and 39 series	331
	Designations	333
	Standard housing design	334
	Housing variants	336
	Sealing solutions	337
	Design considerations	338
	Lubrication	342
	Mounting	342
	Condition monitoring	343
	Accessories	343
	Ordering information	343
	Product tables	
6.1	SED plummer block housings for bearings on an adapter sleeve	344
7	Split plummer block housings – SONL series	349
	Designations	351
	Standard housing design	353
	Housing variants	356
	Sealing solutions	356
	Design considerations	360
	Lubrication	364
	Mounting	368
	Condition monitoring	368
	Accessories	369
	Ordering information	369
	Product tables	
7.1	SONL plummer block housings for bearings on an adapter sleeve, metric shafts	370
7.2	SONL plummer block housings for bearings on an adapter sleeve, inch shafts	374
7.3	SONL plummer block housings for bearings on a cylindrical seat on stepped shafts	378

8 Split pillow blocks – SAF and SAW series (inch dimensions)	383
Designations	385
Standard housing design	386
Housing variants	388
Sealing solutions	389
Using sealed bearings	401
Special seals	104
Design considerations	402
Lubrication	408
Mounting	414
Condition monitoring	415
Accessories	415
Ordering information	416
Product tables	
8.1 SAF pillow blocks with self-aligning ball bearings on an adapter sleeve	418
(Series 15(00), 16(00))	
8.2 SAF and SAW pillow blocks with spherical roller bearings on an adapter sleeve	424
(Series 225(00), 226(00), 230(00)KA, 235(00))	
8.3 SAF pillow blocks with CARB bearings on adapter sleeve	430
(Series C25(00), C26(00), C30(00)KA)	
8.4 SAF pillow blocks with self-aligning ball bearings on a cylindrical seat	434
(Series 13(00), 12(00))	
8.5 SAF and SAW pillow blocks with spherical roller bearings on a cylindrical seat	436
(Series 222(00), 223(00), 232(00))	
8.6 SAF pillow blocks with CARB bearings on a cylindrical seat	444
(Series C22(00), C23(00))	
9 Split pillow blocks – SDAF series including the extended range (inch dimensions) ..	449
Designations	451
Standard housing design	452
Housing variants and customization	453
Sealing solutions	454
Special seals	462
Design considerations	462
Lubrication	467
Mounting	470
Condition monitoring	470
Ordering information	470
Product tables	
9.1 SDAF pillow block housings with spherical roller bearings on an adapter sleeve ..	472
(Series 225(00), 226(00))	
9.2 SDAF pillow block housings with spherical roller bearings on a cylindrical seat ..	474
(Series 222(00), 223(00))	
9.3 SDAF extended range pillow block housings with spherical roller bearings	
on an adapter sleeve	476
(Series 230(00) KA, 231(00) KA, 232(00) KA)	
9.4 SDAF extended range pillow block housings with spherical roller bearings	
on a cylindrical seat	480
(Series 230(00), 231(00), 232(00))	

10 Non-split plummer block housings and take-up housings – SBD and THD series	485
Designations	487
Standard housing design	488
Housing variants	490
Sealing solutions	490
Design considerations	493
Lubrication	498
Mounting	501
Condition monitoring	501
Accessories	501
Ordering information	501
Product tables	
10.1 SBD plummer block housings for bearings on an adapter sleeve on plain shafts	502
10.2 SBD plummer block housings for bearings on an adapter sleeve on stepped shafts	508
10.3 SBD plummer block housings for bearings on a cylindrical seat on stepped shafts	514
10.4 SBD plummer block housings for bearings on a cylindrical seat on multi-stepped shafts	520
10.5 THD take-up housings for bearings on an adapter sleeve on plain shafts	526
11 Flanged housings – FNL series	531
Designations	533
Standard housing design	535
Housing variants	537
Sealing solutions	538
Design considerations	539
Lubrication	542
Mounting	544
Condition monitoring	544
Accessories	544
Ordering information	545
Product tables	
11.1 FNL flanged housings for bearings on an adapter sleeve	546

12 Two-bearing housings – PD series	553
Designations	555
Standard housing design	557
Housing variants	558
Sealing solutions	558
Design considerations	560
Lubrication	567
Mounting	568
Condition monitoring	569
Accessories	569
Ordering information	570
Product tables	
12.1 Two-bearing housings in the PDN series	572
12.2 Two-bearing housings in the PDP series	576
12.3 Two-bearing housings in the PDR series	578
12.4 Shafts for two-bearing housings in the PDN 2 series	580
12.5 Shafts for two-bearing housings in the PDN 3 series	582
12.6 Shafts for two-bearing housings in the PDP series	584
12.7 Shafts for two-bearing housings in the PDR series	586
13 Housings for paper machines – SBFN, SBPN and SDM series	589
Designations	591
Standard housing design	592
Housing variants	594
Sealing solutions	596
Design considerations	598
Lubrication	602
Mounting	603
Condition monitoring	604
Accessories	605
Ordering information	605
Product tables	
13.1 SBPN drying cylinder housings	606
13.2 SBPN drying cylinder housings – short, wide base	608
13.3 SBPN drying cylinder housings, with inch connection threads	610
13.4 SBPN drying cylinder housings, with inch connection threads – short, wide base	612
13.5 SDM Yankee cylinder housings	614
13.6 SDM Yankee cylinder housings with inch connection threads	618
14 Split plummer block housings for converters in steel making – SKND series	623
Designations	625
Housing design	626
Housing variants	629
Sealing solutions	629
Design considerations	630
Lubrication	631
Mounting	632
Accessories	632
Ordering information	633
Product tables	
14.1 SKND plummer block housings for converters	634

15 Trunnion bearing housings for grinding mills – FSDR .. K series	639
Designations	641
Standard housing design	642
Housing variants	644
Sealing solutions	645
Design considerations	648
Lubrication	650
Mounting	652
Condition monitoring	653
Accessories	653
Ordering information	654
Product tables	
15.1 FSDR .. K grinding mill housings	656
16 Metric roller bearing units – SYNT and FYNT series (SKF ConCentra)	659
Designations	661
Standard bearing unit design	662
Bearing unit variants	666
Sealing solutions	667
Design considerations	670
Lubrication	675
Mounting	682
Condition monitoring	684
Accessories	684
Ordering information	685
Product tables	
16.1 SKF ConCentra roller bearing units with a plummer block housing, metric shafts	686
16.2 SKF ConCentra roller bearing units with a flanged housing, metric shafts	688
17 Inch roller bearing units – SYE, SYR, FYE and FYR series	691
Designations	693
Standard bearing unit design	694
Sealing solutions	697
Design considerations	700
Lubrication	706
Mounting	707
Condition monitoring	707
Accessories	707
Ordering information	707
Product tables	
17.1 SKF inch roller bearing units with a two-bolt pillow (plummer) block housing ..	708
17.2 SKF inch roller bearing units with a four-bolt pillow (plummer) block housing ..	714
17.3 SKF inch roller bearing units with a with a square flanged housing	716
17.4 SKF inch roller bearing units with a round or piloted flanged housing	718
18 Indexes	
18.1 Text index	723
18.2 Product index	738
18.3 Bearing index	742

Unit conversions

Unit conversions

Quantity	Unit	Conversion			
Length	inch	1 mm	0.03937 in.	1 in.	25,40 mm
	foot	1 m	3.281 ft.	1 ft.	0,3048 m
	yard	1 m	1.094 yd.	1 yd.	0,9144 m
	mile	1 km	0.6214 mi.	1 mi.	1,609 km
Area	square inch	1 mm ²	0.00155 sq-in	1 sq-in	645,16 mm ²
	square foot	1 m ²	10.76 sq-ft	1 sq-ft	0,0929 m ²
Volume	cubic inch	1 cm ³	0.061 cu-in	1 cu-in	16,387 cm ³
	cubic foot	1 m ³	35 cu-ft	1 cu-ft	0,02832 m ³
	imperial gallon	1 l	0.22 gallon	1 gallon	4,5461 l
	US gallon	1 l	0.2642 US gallon	1 US gallon	3,7854 l
Speed, velocity	foot per second	1 m/s	3.28 ft/s	1 ft/s	0,30480 m/s
	mile per hour	1 km/h	0.6214 mph	1 mph	1,609 km/h
Mass	ounce	1 g	0.03527 oz.	1 oz.	28,350 g
	pound	1 kg	2.205 lb.	1 lb.	0,45359 kg
	short ton	1 tonne	1.1023 short ton	1 short ton	0,90719 tonne
	long ton	1 tonne	0.9842 long ton	1 long ton	1,0161 tonne
Density	pound per cubic inch	1 g/cm ³	0.0361 lb/cu-in	1 lb/cu-in	27,680 g/cm ³
Force	pound-force	1 N	0.225 lbf.	1 lbf.	4,4482 N
Pressure, stress	pounds per square inch	1 MPa	145 psi	1 psi	6,8948 × 10 ³ Pa
		1 N/mm ²	145 psi	1 psi	0,068948 bar
		1 bar	14,5 psi	1 psi	0,068948 bar
Moment	pound-force inch	1 Nm	8.85 lbf-in	1 lbf-in	0,113 Nm
Power	foot-pound per second	1 W	0.7376 ft-lbf/s	1 ft-lbf/s	1,3558 W
	horsepower	1 kW	1.36 hp	1 hp	0,736 kW
Temperature	degree	Celsius	$t_c = 0.555 (t_f - 32)$	Fahrenheit	$t_f = 1,8 t_c + 32$

Foreword

This catalogue contains the standard assortment of SKF housings and roller bearing units typically used in industrial applications. To provide the highest levels of quality and customer service, these products are available worldwide through SKF sales channels. For information about lead times and deliveries, contact your local SKF representative or SKF Authorized Distributor.

The data in this catalogue reflects SKF's state-of-the-art technology and production capabilities as of 2012. The data contained within may differ from that shown in earlier catalogues because of redesign, technological developments, or revised calculation methods. SKF reserves the right to continually improve its products with respect to materials, design and manufacturing methods, some of which are driven by technological developments.

Getting started

This catalogue contains detailed information about all standard SKF metric and inch bearing housings, some application specific housings and SKF roller bearing units. Roller bearing units consist of a housing, a spherical roller bearing, seals and lubricant. These ready-to-mount units can provide a number of advantages when compared to plummer (pillow) block or flanged housings. They are easy and safe to mount and do not require any additional parts.

The first section, which contains general technical information, is designed to help the reader select the best, most effective products for a particular application. In this section, shaft-bearing combinations, sealing solutions and lubrication methods are discussed in detail. Installation and maintenance information is also included. More practical information

about mounting and maintenance is provided in the *SKF bearing maintenance handbook* (ISBN 978-91-978966-4-1).

The latest developments

The latest innovations within the area of SKF bearing housings include:

SE series housings – new housings in accordance with ISO 113

SNL series housings in the 2, 3, 5 and 6 series will be replaced gradually by the new SE housing series. SNL housings are still listed in this catalogue. When a series is converted from SNL to SE, technical updates will be available on skf.com/housings.

SED series housings – largest housings in the standard range

Split housings for bearings with shaft diameters from 430 mm up to 900 mm were typically not standard. A new design concept makes it possible to supply these exceptionally large housings as standard (→ *Split plummer block housings – SED 30, 31, 32 and 39 series, page 331*).

Housings for sealed spherical roller bearings

Sealed spherical roller bearings have been proven to enhance reliability under arduous operating conditions. Consequently, the SKF bearing housing assortment includes housings for these bearings.

Roller bearing units with SKF ConCentra locking technology

Like bearing units with a locking collar, SKF ConCentra roller bearing units are simple and safe to install. The unique SKF ConCentra locking technology provides a truly concentric fit on the shaft, which virtually eliminates fretting corrosion. These units provide the same running accuracy as housing assemblies with sleeve-mounted bearings. (→ *Metric roller bearing units – SYNT and FYNT series, page 659 or Inch roller bearing units – SYE, SYR, FYE and FYR series, page 691*).



SE series housing



SED series housing



Roller bearing unit with SKF ConCentra locking technology

How best to use this catalogue

The catalogue follows an easy principle:

- Chapter 1 provides basic information about bearing housings. It includes a product overview that compares different housing series, sizes, typical shaft-bearing combinations, sealing solutions and lubrication methods. (→ **pages 21 to 53**).
- Chapters 2 to 17 provide information specific to a bearing housing or bearing unit series. Basic design, variants, sealing options and design considerations are discussed in detail. Following that discussion are the product tables.
- Chapter 18 contains the indexes.

Find a housing for a bearing quickly

The bearing index (→ **page 742**) is a quick way to find a housing for a particular bearing. All bearings, which can be accommodated by a housing in this catalogue, are listed per bearing type and sorted alphanumerically, but with cylindrical bore bearings listed before tapered bore bearings.

Find specific information quickly

To make it easy to find specific information, there is a full table of contents at the front of the catalogue. In chapter 18, there is a product index and a full text index.

Find product details quickly

A quick way to access detailed product data is via the product table number. Product table numbers are listed in the full table of contents at the front of the catalogue, in the table of contents at the start of each product chapter and in the product and bearing indexes.

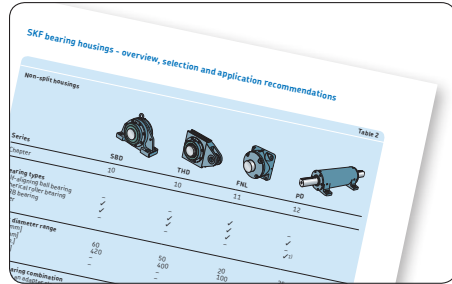

Product overview

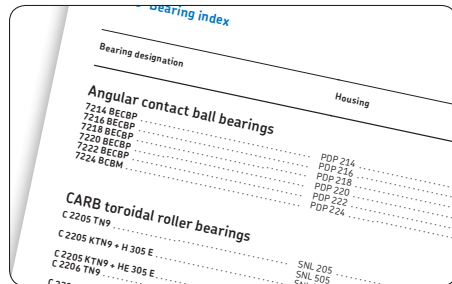

The bearing index lists all bearings and their appropriate housings

9.3

H ₂	J _{min}	J _{max}	J ₁	L	G	Mass
lb.						
3/4	30 1/2	29	8 3/4	35	1 5/8	1100
1	30 1/2	29	8 3/4	35	1 5/8	1050
1	33 1/2	32 3/4	9	38 1/4	1 5/8	1350
1 1/4	33 1/2	32 3/4	9	38 1/4	1 5/8	1250
1 1/4	33 1/2	32 3/4	9	38 1/4	1 5/8	1400
1 1/2	33 1/2	32 3/4	9	38 1/4	1 5/8	1400

Numbered product tables make it easier to access product data.

Identify products

Product designations for SKF bearing housings typically contain information about the housing and additional features. To specify a housing or to find more information about an existing SKF housing, SKF product designations can be found in:

- Product index
The product index at the end of the catalogue lists series designations and relates them to the relevant product chapter and product table.
- Designation charts
Charts in each product chapter provide an overview of commonly used designation prefixes and suffixes.

Units of measurement

This catalogue is for global use. Therefore, the predominant units of measurement are in accordance with ISO 80000-1. Imperial units are used whenever necessary. Unit conversions can be made using the conversion table (→ page 10).

For easier use, temperature values are provided in both, °C and °F. Temperature values are typically rounded. Therefore, the two values do not always match according to the conversion formula.

Series designation	Product
SNL 5...	Plummer block housings for bearings on an adapter
SNL 5...	Plummer block housings for bearings on a cylindrical roller bearing
SNL 6...	Plummer block housings for bearings on an adapter
SNL 6...	Plummer block housings for bearings on a cylindrical roller bearing
SNLN 30...	Plummer block housings for bearings on an adapter
SNLN 30...	Plummer block housings for bearings on a cylindrical roller bearing
SOFN	→ Split plummer block housings for bearings on a cylindrical roller bearing
SONL	Plummer block housings for bearings on an adapter
SONL	Plummer block housings for bearings on a cylindrical roller bearing
SONL	Plummer block housings – SONL series
SVE	Plummer block housings for bearings on an adapter
SVE... N	Plummer block housings for bearings on an adapter
SVNT	Inch roller bearings
SKF	SKF

The product index makes finding information based on a bearing's designation easy.

Designations	
Designation system for SNLN 30 plummer block housings	
Prefix for ball bores	S
Two aligned cent holes for attachment bolts. Not used for attachment bolts (only for housings made of superalloy/graphite cast iron)	
Series	SNLN
Standard plummer block housing	
Material	D
Grey cast iron Sintered or light grey cast iron	
Size identification	3024 EN
30 (mm) Housing for bearings in the 30 (or 40) diameter series 024 Size code of the bearing. (B) × D × B = bearing bore diameter (mm)	
Suffixes	
7	
8	

Designation chart to decode housing designations

More SKF housings and units

Application specific housings

The SKF design and manufacturing capabilities for bearing housings are not limited to the products described in this catalogue. SKF has supplied bearing and housing solutions for various applications including:

- main shaft support for wind turbines
- rudder or drive shaft support for ships
- rail bound vehicles
- moveable bridges
- housings for split bearings

Customized housings

SKF can design custom housings using state-of-the-art finite element analysis. Prior to prototyping, SKF engineers can add their bearing, and seal expertise and confirm the integrity of the system on a virtual test rig. SKF housing manufacturing facilities are able to produce bearing housings for nearly all SKF rolling bearings.

Y-bearing units

Y-bearing units consist of a housing, a deep groove ball bearing, seals or shields and grease. These ready to mount units are available in a variety of shapes and sizes. For additional information about these products, visit skf.com/bearings.

Previous housing series

Some housing series are no longer available and are not listed in this catalogue. If replacement parts are required, especially for housings in the SOFN or SDG series, contact SKF.

This is SKF

From one simple but inspired solution to a friction problem in a mill in Sweden, and a handful of engineers in 1907, SKF has grown to become a global industrial knowledge leader. Over the years we have built on our expertise in bearings, extending it to seals, mechatronics, services and lubrication systems. Our knowledge network includes 46 000 employees, 15 000 distributor partners, offices in more than 130 countries, and a growing number of SKF Solution Factories around the world.



Research and development

We have hands-on experience in over forty industries, based on our employees' knowledge of real life conditions. In addition our world-leading experts and university partners who pioneer advanced theoretical research and development in areas including tribology, condition monitoring, asset management and bearing life theory. Our ongoing commitment to research and development helps us keep our customers at the forefront of their industries.



SKF Solution Factories make SKF knowledge and manufacturing expertise available locally, to provide unique solutions and services to our customers

Meeting the toughest challenges

Our network of knowledge and experience along with our understanding of how our core technologies can be combined helps us create innovative solutions that meet the toughest of challenges. We work closely with our customers throughout the asset life cycle, helping them to profitably and responsibly grow their businesses.



Working for a sustainable future

Since 2005, SKF has worked to reduce the negative environmental impact from our own operations and those of our suppliers. Our continuing technology development introduced the SKF BeyondZero portfolio of products and services which improve efficiency and reduce energy losses, as well as enable new technologies harnessing wind, solar and ocean power. This combined approach helps reduce the environmental impact both in our own operations and in our customers'.

Working with SKF IT and logistics systems and application experts, SKF Authorized Distributors deliver a valuable mix of product and application knowledge to customers worldwide.



SKF – the knowledge engineering company

Our knowledge – your success

SKF Life Cycle Management is how we combine our technology platforms and advanced services, and apply them at each stage of the asset life cycle, to help our customers to be more successful, sustainable and profitable.

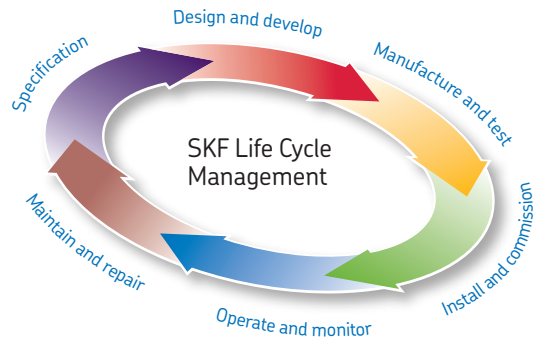

Working closely with you

Our objective is to help our customers improve productivity, minimize maintenance, achieve higher energy and resource efficiency, and optimize designs for long service life and reliability.

Innovative solutions

Whether the application is linear or rotary or a combination of the two, SKF engineers can work with you at each stage of the asset life cycle to improve machine performance by looking at the

entire application. This approach doesn't just focus on individual components like bearings or seals. It looks at the whole application to see how each component interacts with the next.

Design optimization and verification

SKF can work with you to optimize current or new designs with proprietary 3-D modeling software that can also be used as a virtual test rig to confirm the integrity of the design.



Bearings

SKF is the world leader in the design, development and manufacture of high performance rolling bearings, plain bearings, bearing units and housings.



Machinery maintenance

Condition monitoring technologies and maintenance services from SKF can help minimize unplanned downtime, improve operational efficiency and reduce maintenance costs.



Sealing solutions

SKF offers standard seals and custom engineered sealing solutions to increase uptime, improve machine reliability, reduce friction and power losses, and extend lubricant life.



Mechatronics

SKF fly-by-wire systems for aircraft and drive-by-wire systems for off-road, agricultural and forklift applications replace heavy, grease or oil consuming mechanical and hydraulic systems.



Lubrication solutions

From specialized lubricants to state-of-the-art lubrication systems and lubrication management services, lubrication solutions from SKF can help to reduce lubrication related downtime and lubricant consumption.



Actuation and motion control

With a wide assortment of products – from actuators and ball screws to profile rail guides – SKF can work with you to solve your most pressing linear system challenges.

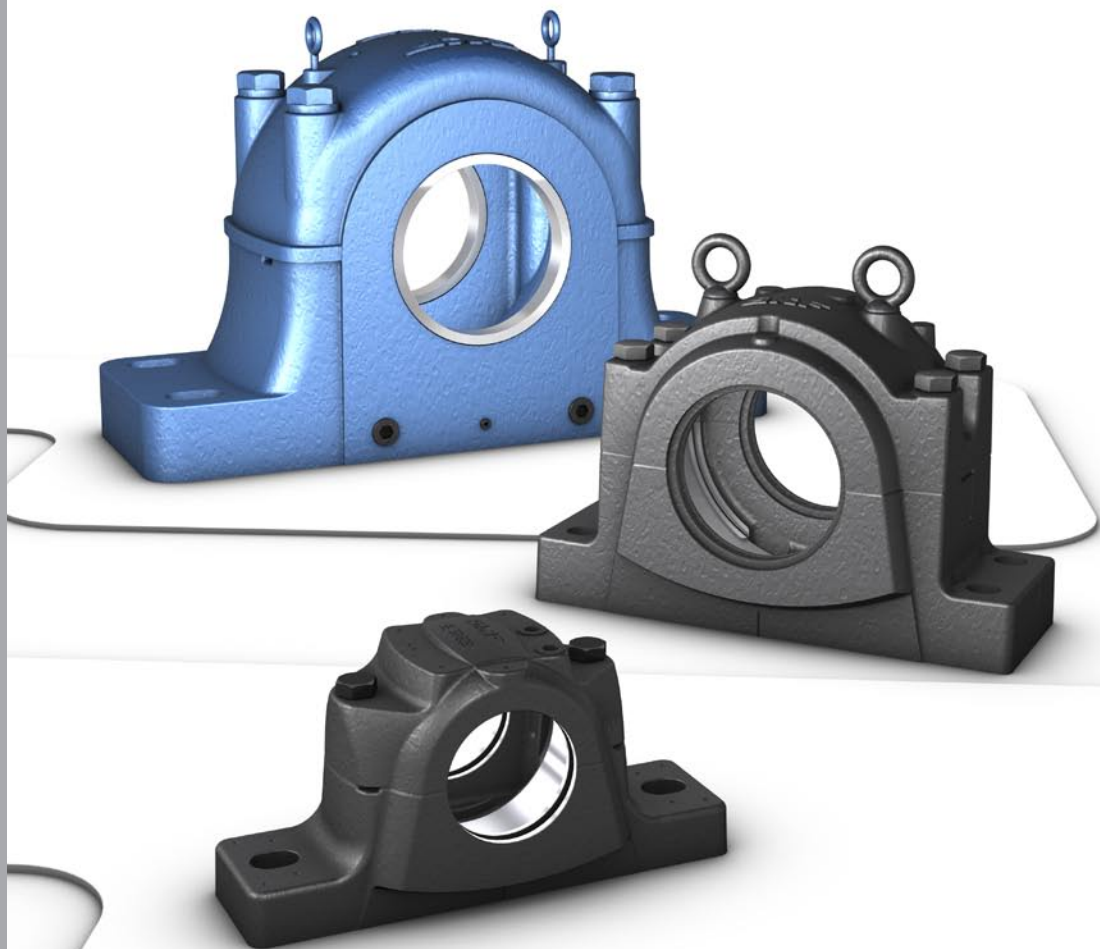

SKF bearing housings – overview, selection and application recommendations

Basics	22	Mounting	50
Terminology	22	Preparations prior to mounting	50
Overview of SKF bearing housings	27	SKF tools and products	50
Assortment	27	Lifting housings	50
Housing materials	29	Attachment bolt tightening	50
Selecting a housing	35	Using shims	50
Environmental conditions	36	Using locating (stabilizing) rings	50
Custom painting / corrosivity category	36	Installing seals	51
Sealing solutions	36	Inspection and condition monitoring ...	52
The SKF three-barrier solution	39	Storage	52
Design considerations	40		
Bearing systems	40		
Locating/non-locating bearing systems ..	40		
The SKF self-aligning bearing system ..	41		
Typical shaft-bearing combinations ...	41		
Load carrying ability	44		
Breaking loads	44		
Safe loads	44		
Axial load carrying ability for bearings on a sleeve	44		
Specifications for shafts and housing support surfaces	45		
Shaft	45		
Housing support surface	45		
Lubrication	46		
Grease selection	46		
Initial grease fill	46		
Relubrication	46		
SKF tools and products	47		

Basics

The purpose of a bearing housing is to:

- support the bearing and transmit operating static and dynamic loads
- protect the bearing and lubricant from contaminants
- contain the lubricant and accommodate lubrication system components
- accommodate monitoring system components
- maximize the performance and service life of the incorporated bearings

Terminology

An overview of the terminology used in this catalogue is provided in **figs. 1 to 4**:

- types of bearing housings and bearing units
(→ **fig. 1**)
- split plummer (pillow) block housings
(→ **fig. 2**)
- housing and shaft arrangements
(→ **figs. 3 and 4**)

Fig. 1

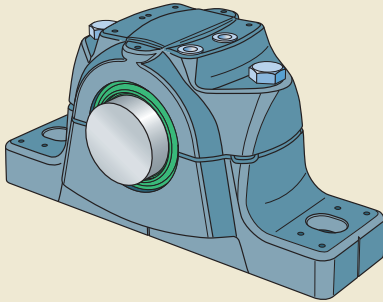

Split plummer (pillow) block housing

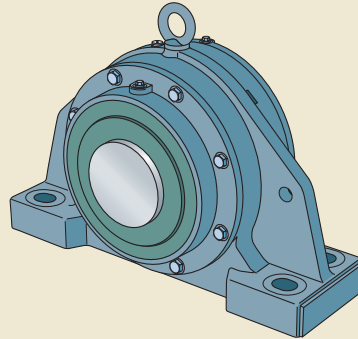

Non-split plummer (pillow) block housing

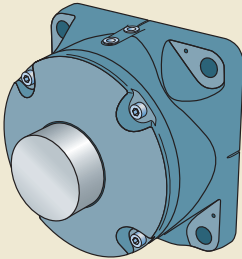

Flanged housing

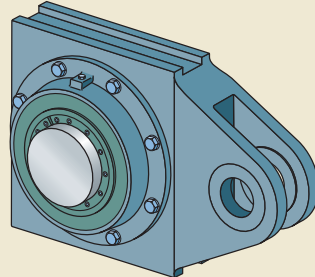

Take-up housing

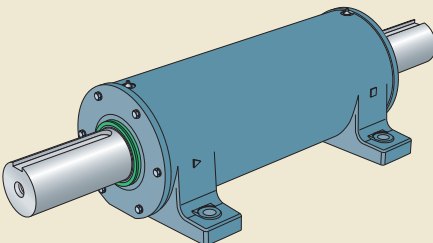

Two-bearing housing

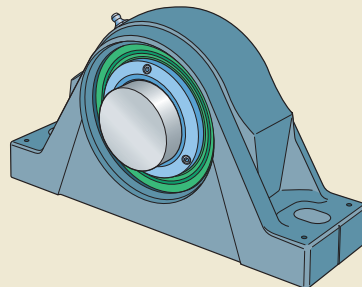

Roller bearing unit

Fig. 2

SE plummer (pillow) block housing

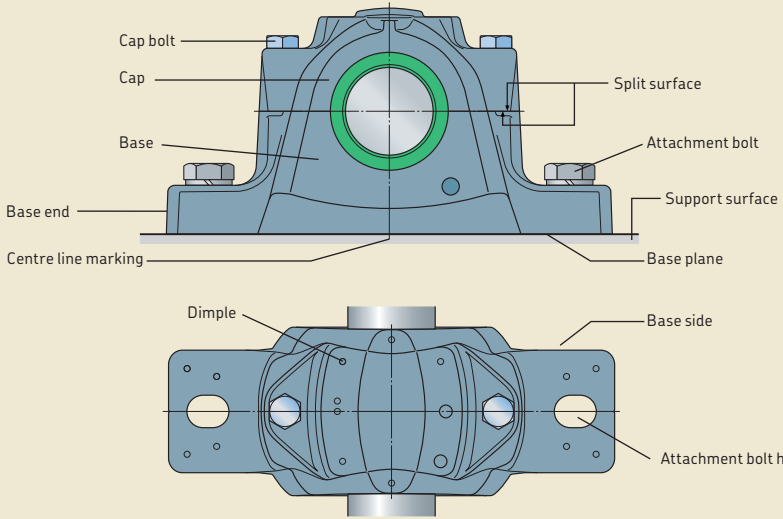

SONL plummer (pillow) block housing

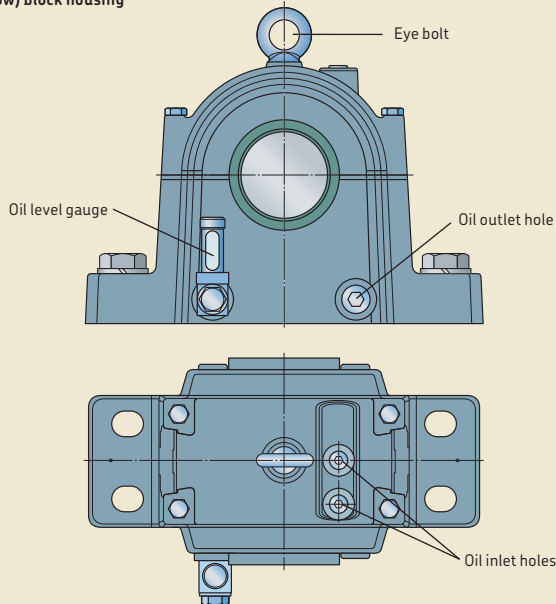
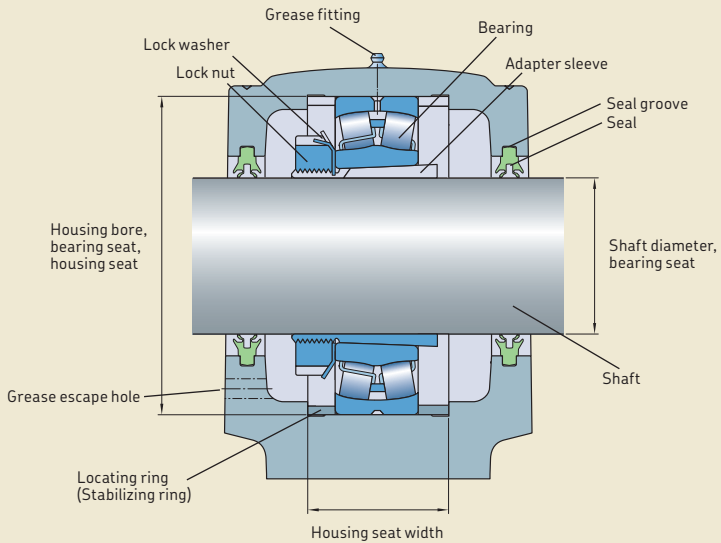

Fig. 3

SE plummer (pillow) block housing



FNL flanged housing

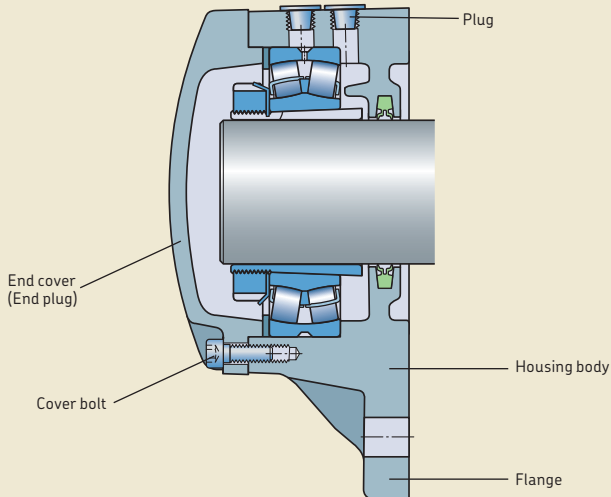
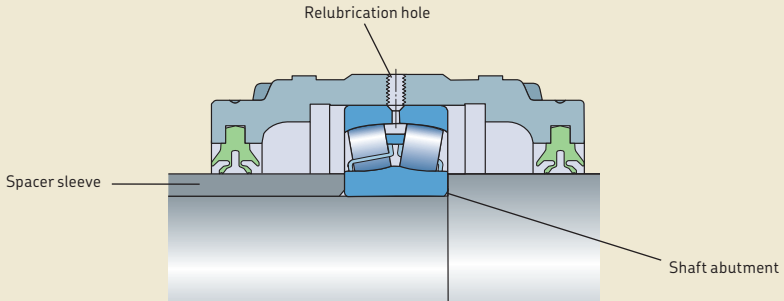
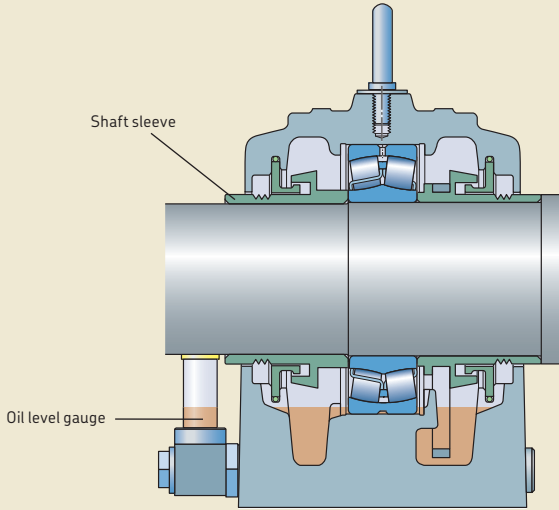

Fig. 4



Overview of SKF bearing housings

Assortment

The comprehensive assortment of SKF bearing housings is provided in **tables 1 to 4**, starting on **page 30**. SKF can also supply custom housings for specific applications and requirements. For additional information, contact the SKF application engineering service.

Split plummer (pillow) block housings

The main benefit of split plummer (pillow) block housings (→ **fig. 5**) is that they can accommodate preassembled shafts. Also, these housings simplify bearing inspections and maintenance because the shaft does not need to be disassembled.

The assortment of split plummer block housings is provided in **table 1** on **page 30**. Application-specific housings are provided in **table 4** on **page 34**.

Non-split plummer (pillow) block housings

Non-split plummer (pillow) block housings (→ **fig. 6**) are preferred when there are heavy loads acting in directions other than toward the support surface. They are also used when the housing has to be mounted from the end of the shaft.

The assortment of non-split plummer block housings is provided in **table 2** on **page 32**. Application-specific housings are provided in **table 4** on **page 34**.

Flanged housings

Flanged housings (→ **fig. 7**) provide a solution for applications that do not have a frame parallel to the shaft. The assortment of flanged housings is provided in **table 2** on **page 32**.

Fig. 5



Fig. 6

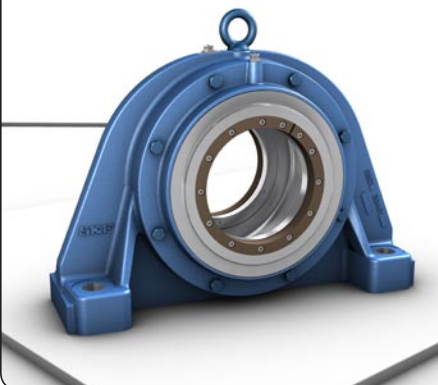

Fig. 7



Take-up housings

Take-up housings (→ **fig. 8**) are typically used to maintain the tension in conveyor belt applications and are mounted onto a guide frame.

The assortment of take-up housings is provided in **table 2** on **page 32**.

Two-bearing housings

Two-bearing housings (→ **fig. 9**) have intrinsically aligned bearing seats. As a result, they can accommodate rigid bearings, such as deep groove ball bearings, angular contact ball bearings and cylindrical roller bearings. Two-bearing housings are typically used in applications with an overhanging load.

The assortment of two-bearing housings is provided in **table 2** on **page 32**.

Roller bearing units

Roller bearing units consist of a bearing, housing, lubricant and seals as well as a mechanism to lock the bearing inner ring onto the shaft (→ **fig. 10**). These ready-to-mount units are assembled, lubricated and sealed at the factory for maximum service life. Bearing units require very little maintenance. They are also easy to install and replace. Once a unit is bolted to its support surface, only the grub (set) screws in the collar need to be tightened.

The assortment of roller bearing units is provided in **table 3** on **page 33**.

Application-specific housings

Application-specific housings have features that enable them to be used in special operating conditions. The assortment of application-specific housings is provided in **table 4** on **page 34**.

Fig. 8

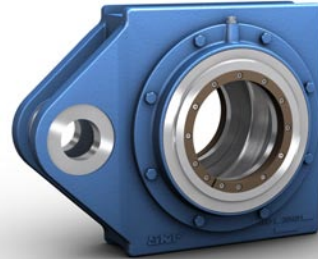

Fig. 9

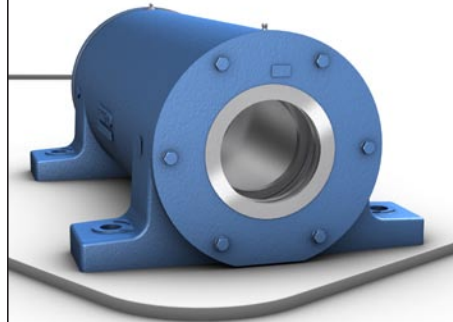

Fig. 10



Housing materials

SKF housings are typically made of either grey cast iron or spheroidal graphite cast iron. For information about the material options available for a particular housing type, refer to **tables 1 to 4**, starting on **page 30**, or the relevant product chapter.

Grey cast iron

Grey cast iron is the standard material for most SKF housings and is sufficient for the majority of applications. It is characterized by high strength, good damping capability and good thermal conductivity.

Spheroidal graphite cast iron

Spheroidal graphite cast iron contains graphite nodules, making it ductile. It therefore provides a higher degree of strength and toughness than grey cast iron. On average, housings made of spheroidal graphite cast iron can withstand 1,8 times heavier loads compared to housings made of grey cast iron.

SKF bearing housings – overview, selection and application recommendations

Split plummer (pillow) block housings

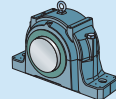
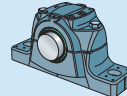
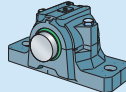

Series	SNL 2, 3, 5 and 6	SE 2, 3, 5 and 6	SNLN 30
Chapter	2	3	4
Bearing types			
Self-aligning ball bearing	✓	✓	–
Spherical roller bearing	✓	✓	✓
CARB bearing	✓	✓	✓
Shaft diameter range			
from [mm]	20	30	110
to [mm]	160	160	280
from [in.]	3/4	1 1/8	–
to [in.]	5 1/2	5 1/2	–
Shaft-bearing combination			
Bearing on an adapter sleeve	✓	✓	✓
Bearing on a withdrawal sleeve	✓	✓	✓
Bearing on a cylindrical seat	✓	✓	✓
Sealing solutions			
Lip seal	✓	✓	✓ ¹⁾
Radial shaft seal	–	–	–
V-ring seal	✓	✓	✓ ¹⁾
Felt seal	✓	✓	✓ ¹⁾
Labyrinth seal	✓	✓	✓
Taconite heavy-duty seal	✓	✓	✓
Multi-seal	–	–	–
Lubrication			
Grease	✓	✓	✓
Oil	optional	optional ²⁾	–
Materials			
Grey cast iron	standard	standard	standard
Spheroidal graphite cast iron	optional	optional	optional
Cast steel	–	–	–
Mounting			
No attachment bolts	✓	✓	✓
Two-bolt mounting	✓	✓	✓
Four-bolt mounting	✓	✓	✓
Eight-bolt mounting	–	–	–
Supersedes (SKF)	SNH, SNA, SN	SNL 2,3,5 and 6, SNH, SNA, SN	SN 30
Replacement for (non-SKF)	ISO 113 standard housing	ISO 113 standard housing	ISO 113 standard housing

¹⁾ Not available for sizes 34 and above.

²⁾ For sizes 518 to 532 circulating oil only.

Overview of SKF bearing housings

Table 1



				
SNL 30, 31 and 32	SED	SONL	SAF, SAW	SDAF
5	6	7	8	9
-	-	✓	✓	-
✓	✓	✓	✓	✓
✓	✓	✓	✓	✓
115 530 4 ^{7/16} 19 ^{1/2}	430 900 -	75 240 2 ^{15/16} 8 ^{15/16}	40 220 1 ^{3/16} 10 ^{1/2}	85 530 2 ^{15/16} 20
✓	✓	✓	✓	✓
✓	-	-	✓	-
✓	✓	✓	✓	✓
-	-	-	-	-
-	-	-	✓	✓
-	-	-	✓	✓
✓	-	✓	✓	✓
✓	-	-	✓	✓
-	✓	-	-	-
✓	✓	-	✓	✓
✓	✓	✓	✓	✓
standard optional -	- standard -	standard optional -	standard optional optional	standard optional optional
-	-	-	-	-
-	-	-	✓	✓
✓	-	✓	✓	✓
-	✓	-	-	-
SD, SDD	-	SOFN 2, 5	-	-
ISO 113 standard housing	-	-	-	-

Table 2



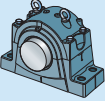
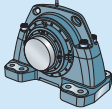
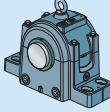
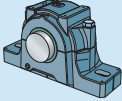
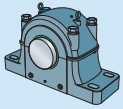
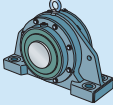
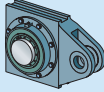

Non-split housings				
				
Series	SBD	THD	FNL	PD
Chapter	10	10	11	12
Bearing types				
Self-aligning ball bearing	–	–	✓	–
Spherical roller bearing	✓	✓	✓	✓
CARB bearing	✓	✓	✓	–
Other	–	–	–	✓ ¹⁾
Shaft diameter range				
from [mm]	60	50	20	25
to [mm]	420	400	100	120
from [in.]	–	–	–	–
to [in.]	–	–	–	–
Shaft-bearing combination				
Bearing on an adapter sleeve	✓	✓	✓	–
Bearing on a withdrawal sleeve	–	–	–	–
Bearing on a cylindrical seat	✓	✓	–	✓
Sealing solutions				
Lip seal	–	–	✓	–
V-ring seal	–	–	–	✓
Felt seal	–	–	–	✓
Labyrinth seal	✓	✓	–	–
Lubrication				
Grease	✓	✓	✓	✓
Oil	–	–	–	optional
Materials				
Grey cast iron	optional	optional	standard	standard
Spheroidal graphite cast iron	standard	standard	–	–
Cast steel	optional	optional	–	–
Mounting				
No attachment bolts	–	n/a	–	–
Two-bolt mounting	–	n/a	–	–
Four-bolt mounting	✓	n/a	✓ ²⁾	✓
Supersedes (SKF)				
	–	–	7225(00)	–

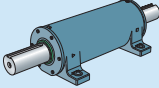
¹⁾ Typical bearings include deep groove ball bearings, angular contact ball bearings, and cylindrical roller bearings.

²⁾ Housings with a triangular flange have three attachment bolts.

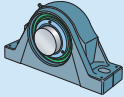
Table 3

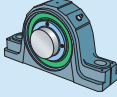
Roller bearing units

				
Series	SYNT	FYNT	SYE .. N, SYR .. N, FSYE	FYE, FYR, FYRP
Chapter	16	16	17	17
Bearing types				
Self-aligning ball bearing	–	–	–	–
Spherical roller bearing	✓	✓	✓	✓
CARB bearing	–	–	–	–
Shaft diameter range				
from [mm]	35	35	–	–
to [mm]	100	100	–	–
from [in.]	–	–	1 7/16	1 7/16
to [in.]	–	–	4 15/16	4
Locking method				
SKF ConCentra	✓	✓	✓	✓
Locking collar	–	–	✓	✓
Sealing solutions				
Lip seal	✓	✓	✓	✓
Radial shaft seal	✓	–	✓	✓
Labyrinth seal	✓	–	✓	✓
Lubrication				
Grease	✓	✓	✓	✓
Oil	–	–	–	–
Materials				
Grey cast iron	✓	✓	✓	✓
Mounting				
No attachment bolts	–	–	–	–
Two-bolt mounting	✓	–	✓	–
Four-bolt mounting	–	✓ ¹⁾	✓	✓
Supersedes (SKF)	SYT	–	–	–

¹⁾ Housings with a triangular flange have three attachment bolts.

Table 4

Application-specific housings

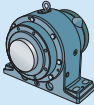
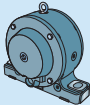
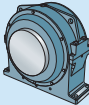
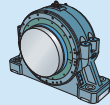
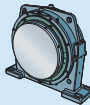
					
Series	SBPN	SBFN	SDM	SKND	FSDR
Chapter	13	13	13	14	15
Application	Drying cylinder	Felt roll	Yankee cylinder	Converter trunnion	Mill trunnion
Bearing types					
Self-aligning ball bearing	–	–	–	–	–
Spherical roller bearing	✓	✓	✓	✓	✓
CARB bearing	✓	✓	✓	✓	–
Shaft diameter range					
from [mm]	180	60	340	530	825
to [mm]	320	180	670	1 180	1 460
from [in.]	1) ¹⁾	1) ¹⁾	1) ¹⁾	1) ¹⁾	1) ¹⁾
to [in.]	1) ¹⁾	1) ¹⁾	1) ¹⁾	1) ¹⁾	1) ¹⁾
Shaft-bearing combination					
Bearing on an unthreaded sleeve	–	–	–	–	✓ ²⁾
Bearing on a cylindrical seat	–	optional	–	✓	–
Bearing on a tapered seat	✓	✓	✓	–	–
Sealing solutions					
Lip seal	–	–	–	✓	–
V-ring seal	–	–	–	–	✓
Labyrinth seal	✓	✓	–	–	✓
Gap-type seal	–	–	✓	–	–
Lubrication					
Grease	–	–	–	✓	✓
Oil	✓	✓	✓	–	–
Materials					
Grey cast iron	✓	✓	✓	–	✓
Spheroidal graphite cast iron	–	–	–	✓	optional
Mounting					
No attachment bolts	–	–	–	–	–
Two-bolt mounting	–	✓	–	–	–
Four-bolt mounting	✓	optional	✓	✓	✓
Supersedes (SKF)	SBP	SBF ²⁾	–	SDKD	–

¹⁾ Contact SKF.

²⁾ Housings are still available.

Selecting a housing

When selecting a housing, many factors should be considered. The selection process depends not only on the bearing type and size but also on the ability of the housing to safely accommodate the magnitude and characteristics of all applied loads. Beside this, important considerations are mounting, maintenance, sealing options and bearing lubricant requirements.

Search for a housing

To identify housings that are suitable for a specific bearing type, size and shaft-bearing combination, use the *Bearing index*, starting on **page 742**, or the online application *SKF Housing Select*, available at skf.com/housings. Also keep in mind that a roller bearing unit may be the preferred solution (→ **table 5**). An online search facility for bearing units is also available at skf.com/housings.

Adjust the bearing selection

If there is no suitable housing for the selected bearing type or size, consider switching to a bearing that can be accommodated in a standard housing. The result will be a more cost-effective bearing/housing solution.

Select the final housing variant

Once a housing has been selected, be sure that the housing and available sealing solutions will accommodate the loads, shaft-bearing combination, lubrication method and operating conditions, e.g. type and level of contaminants. Consider all housing variants, including those with a non-standard seat tolerance or special seals. For unique requirements, contact the SKF application engineering service.

Table 5

Housing equivalents

Housing series	Roller bearing unit
SNL 5 series	SKF ConCentra roller bearing units in the SYNT series
FNL series	SKF ConCentra roller bearing units in the FYNT series

Environmental conditions

SKF housings are intended for both interior and exterior applications. The following corrosivity categories, in accordance with ISO 12944-2, are applicable for SKF housings:

- C2 for all housings except SE and SED plummer (pillow) block housings
- C3 for SE and SED plummer (pillow) block housings

Additional information about corrosivity categories is provided in **table 6**.

Custom painting / corrosivity category

The standard colour and corrosivity category of an SKF housing is indicated in the relevant product chapter. SKF housings can also be supplied in other colours and/or corrosivity categories (→ **table 6**) or according to customer specifications. Housings that have a non-standard painting requirement are identified by the designation suffix P followed by a unique two- or three-digit number e.g. SNL 510-608/P76.

If a housing is going to be repainted, SKF recommends taking the following precautions prior to painting:

- Cover all housing openings. For housings with seal grooves, place discs cut from cardboard or plastic in the seal grooves. This is particularly important because residual chemicals or abrasives from the preparation process can lead to premature bearing and seal damage.
- Remove all grease fittings and protect all threaded holes with plugs.
- To avoid any chemical attack of the surface when washing painted castings, follow the instructions from the supplier of the washing chemicals regarding concentration, temperature, and time. The paint is resistant to commonly used low alkaline washing chemicals.

Sealing solutions

The performance of a sealing arrangement is vital to the cleanliness of the lubricant and the service life of the bearings. The type of seal should be selected based on the lubricant type and operating speed but levels of contamination and misalignment should also be considered.

There is a wide assortment of SKF housing seals. Some housings can accommodate different types of seals, while other housings are designed for one specific sealing solution. For information about the sealing solutions available for a particular housing or roller bearing unit, refer to **tables 1 to 4**, starting on **page 30**, or the relevant product chapter. The properties, application conditions and suitability of each sealing solution are also provided in the relevant product chapter.

Converting circumferential to rotational speeds

To convert the circumferential speed limit of a sealing solution to the equivalent rotational speed, refer to **table 7**.

Table 6

Corrosivity categories¹⁾

Corrosivity category	Examples of typical environments in a temperate climate	
	Exterior	Interior
C1 (very low)	–	Heated buildings with clean atmospheres, e.g. offices, shops, schools, hotels.
C2 (low)	Atmospheres with low levels of pollution. Typically inland rural areas.	Unheated buildings where condensation may occur, e.g. depots, sport halls.
C3 (medium)	Urban and industrial atmospheres with moderate levels of sulphur dioxide. Coastal areas with low salinity.	Production rooms with high humidity and some air pollution, e.g. food-processing plants, laundries, breweries, dairies.
C4 (high)	Industrial and coastal areas with moderate salinity.	Chemical plants, swimming pools, coastal ship- and boatyards.
C5-I (very high, industrial)	Industrial areas with high humidity and aggressive atmosphere.	Buildings or areas with almost permanent condensation and with high pollution.
C5-M (very high, marine)	Coastal and offshore areas with high salinity. ²⁾	Buildings or areas with almost permanent condensation and with high pollution.

¹⁾ In accordance with ISO 12944-2.

²⁾ In hot, humid coastal areas, the mass loss or thickness loss can exceed the limits of category C5-M and special precautions should be taken when selecting protective paint systems.

Table 7

Converting circumferential speed limits to rotational speeds

Shaft diameter at the seal lip	Rotational speed for circumferential speed limits					
	2 m/s	4 m/s	7 m/s	8 m/s	12 m/s	13 m/s
mm	r/min					
20	1 910	3 820	6 680	7 640	11 460	12 410
25	1 530	3 060	5 350	6 110	9 170	9 930
30	1 270	2 550	4 460	5 090	7 640	8 280
35	1 090	2 180	3 820	4 370	6 550	7 090
40	950	1 910	3 340	3 820	5 730	6 210
45	850	1 700	2 970	3 400	5 090	5 520
50	760	1 530	2 670	3 060	4 580	4 970
55	690	1 390	2 430	2 780	4 170	4 510
60	640	1 270	2 230	2 550	3 820	4 140
65	590	1 180	2 060	2 350	3 530	3 820
70	550	1 090	1 910	2 180	3 270	3 550
75	510	1 020	1 780	2 040	3 060	3 310

continues on next page

Converting circumferential speed limits to rotational speeds

Shaft diameter at the seal lip	Rotational speed for circumferential speed limits					
	2 m/s	4 m/s	7 m/s	8 m/s	12 m/s	13 m/s
mm	r/min					
80	480	950	1 670	1 910	2 860	3 100
85	450	900	1 570	1 800	2 700	2 920
90	420	850	1 490	1 700	2 550	2 760
95	400	800	1 410	1 610	2 410	2 610
100	380	760	1 340	1 530	2 290	2 480
110	350	690	1 220	1 390	2 080	2 260
115	330	660	1 160	1 330	1 990	2 160
120	320	640	1 110	1 270	1 910	2 070
125	310	610	1 070	1 220	1 830	1 990
130	290	590	1 030	1 180	1 760	1 910
135	280	570	990	1 130	1 700	1 840
140	270	550	950	1 090	1 640	1 770
145	260	530	920	1 050	1 580	1 710
150	250	510	890	1 020	1 530	1 660
155	250	490	860	990	1 480	1 600
160	240	480	840	950	1 430	1 550
165	230	460	810	930	1 390	1 500
170	220	450	790	900	1 350	1 460
175	220	440	760	870	1 310	1 420
180	210	420	740	850	1 270	1 380
185	210	410	720	830	1 240	1 340
195	200	390	690	780	1 180	1 270
200	190	380	670	760	1 150	1 240
205	190	370	650	750	1 120	1 210
215	180	360	620	710	1 070	1 150
220	170	350	610	690	1 040	1 130
240	160	320	560	640	950	1 030
255	150	300	520	600	900	970
260	150	290	510	590	880	950
275	140	280	490	560	830	900
280	140	270	480	550	820	890
295	130	260	450	520	780	840
300	130	250	450	510	760	830
320	120	240	420	480	720	780
340	110	220	390	450	670	730
360	110	210	370	420	640	690
380	100	200	350	400	600	650
400	100	190	330	380	570	620
410	90	190	330	370	560	610
430	90	180	310	360	530	580
450	80	170	300	340	510	550
470	80	160	280	330	490	530
500	80	150	270	310	460	500

The SKF three-barrier solution

For highly contaminated environments, SKF recommends the three-barrier solution. This cost-effective sealing solution can have a significant impact on bearing service life as contaminants have to pass through three barriers to reach the bearing (→ **fig. 11**):

- 1st barrier – external housing seal
- 2nd barrier – housing grease
- 3rd barrier – integral bearing seal

The SKF three-barrier solution consists of a sealed SKF bearing, a housing with a 70 to 90% grease fill, and labyrinth housing seals.

Sealed bearings have integral contact seals that keep the lubricant in and contaminants out of the bearing cavity during operation. The seals also protect the bearing from the ingress of contaminants during installation. Using a sealed bearing also means that the grease used to fill the housing and labyrinth seals is independent of the lubrication requirements for the bearing. Therefore, environmentally friendly, biodegradable greases, such as SKF LGGB 2, can be used to fill the housing (→ skf.com/lubrication).

When the SKF self-aligning bearing system is used (→ **page 41**), the labyrinth seal for the CARB toroidal roller bearing should be replaced with a taconite seal.

Fig. 11

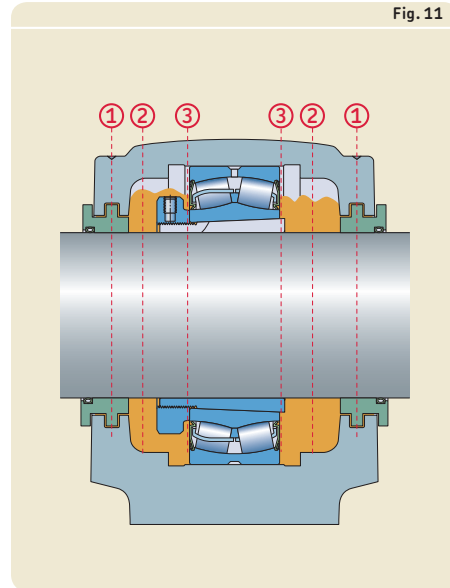

Design considerations

SKF housings are typically designed for self-aligning ball bearings, spherical roller bearings and CARB toroidal roller bearings. These bearings are chosen because they are insensitive to initial misalignment, which normally occurs when the housings are spaced far apart.

Two-bearing housings have inherently aligned bearing seats and therefore can accommodate rigid bearings such as deep groove ball bearings, angular contact ball bearings and cylindrical roller bearings.

Bearing systems

Locating/non-locating bearing systems

Conventional locating/non-locating bearing systems (→ **fig. 15**) are designed to accommodate thermal elongation of the shaft. In these systems, the non-locating bearing must be able to move axially on its seat in the housing.

SKF housings can accommodate bearings in both the locating and non-locating positions. Most standard housings have a bearing seat that is sufficiently wide to enable axial displacement of the non-locating bearing (→ **fig. 12**, “s”). When these housings are used in the locating position, locating (stabilizing) ring(s) should be used to secure the bearing axially in the housing (→ **fig. 13**).

Some SKF housing series are available with a wide bearing seat for axial displacement, designation suffix L, and a bearing seat that matches the width of the bearing to locate it axially, designation suffix F (→ **fig. 14**).

Fig. 12

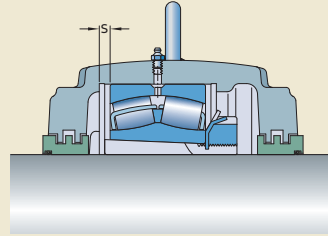

Wide bearing seat for the non-locating bearing position

Fig. 13

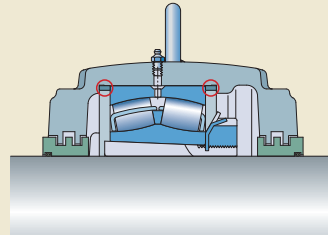

Locating bearing held axially by locating rings

Fig. 14

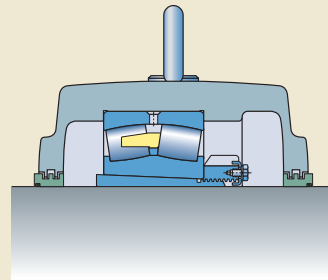

Locating bearing held axially by a matched bearing seat

The SKF self-aligning bearing system

To accommodate misalignment and shaft deflections, conventional self-aligning bearing systems use spherical roller or self-aligning ball bearings in both the locating and non-locating bearing positions (→ **fig. 15**). To accommodate thermal elongation of the shaft in these systems, the non-locating bearing must be able to move axially on its seat in the housing. Any wear or damage to the housing seat results in a “stick-slip” condition that induces axial loads, friction, and heat into the bearing system.

A better solution is to use a CARB toroidal roller bearing in the non-locating position (→ **fig. 15**). CARB bearings accommodate misalignment and shaft deflections. They also accommodate thermal elongation of the shaft within the bearing, with virtually no friction, to avoid induced axial loads.

Because CARB bearings do not accommodate axial loads, these bearings must always be secured axially in the housing, with either locating (stabilizing) rings or by using a housing variant with an F (or RA for some housings) in its designation suffix.

Compared to conventional self-aligning bearing systems, replacing the non-locating bearing with a CARB bearing increases the load carrying capacity of the bearing system, enabling a more compact, and therefore lighter, bearing arrangement to be used. By virtually eliminating induced axial loads, vibration levels and temperatures are reduced and less grease is consumed, resulting in less mainten-

ance. The solution contributes to improved reliability and extended bearing service life.

Typical shaft-bearing combinations

Bearings in SKF housings can be mounted either directly on a shaft or on a sleeve on the shaft. There are four typical combinations (→ **table 8, pages 42–43**):

- plain shaft with bearing on an adapter sleeve
- stepped shaft with bearing on an adapter sleeve
- stepped shaft with bearing on a withdrawal sleeve
- stepped shaft with bearing on a cylindrical seat

For information about the shaft-bearing combination alternatives for a particular housing type, refer to **tables 1 to 4**, starting on **page 30**, or the relevant product chapter.

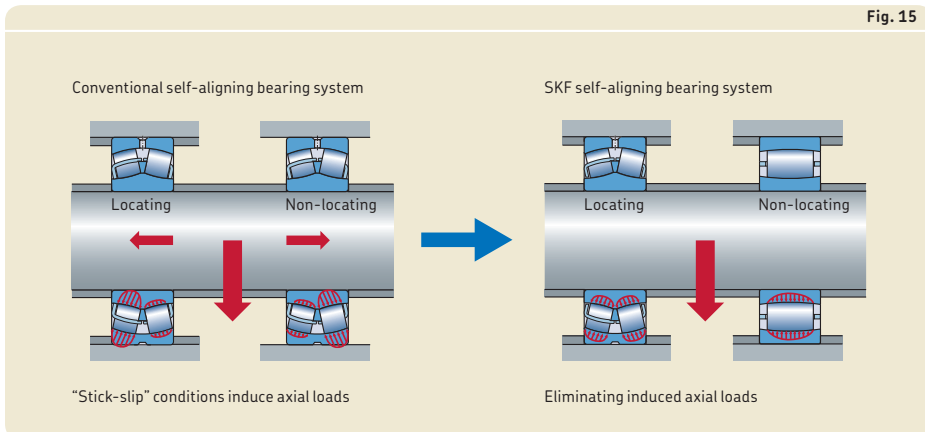

Comparison of typical shaft-bearing combinations

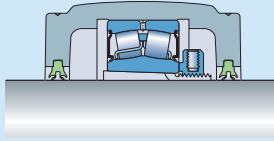

Plain shaft with bearing on an adapter sleeve

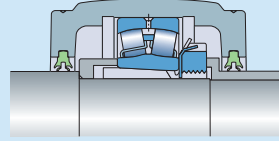

Stepped shaft with bearing on an adapter sleeve

Shaft	<ul style="list-style-type: none"> • Machining not required, drawn round bars (h9 or better) can be used • Maximum shaft strength (no shoulders or undercuts) 	<ul style="list-style-type: none"> • Machining required, typically two steps • Shaft strength weakened by shoulders
Bearing	<ul style="list-style-type: none"> • Bearing can be mounted at any position on the shaft • Internal clearance changes during mounting (proper drive-up required) • Axial load carrying capacity limited by the adapter sleeve 	<ul style="list-style-type: none"> • Bearing position determined accurately by the stepped ring • Internal clearance changes during mounting (proper drive-up required) • Axial load carrying capacity limited by the shaft sleeve or adapter sleeve in one direction and by the bearing and housing in the other direction
Mounting and dismounting	<p>40% less mounting force required compared to other sleeve mounted arrangements as friction only occurs between two mating surfaces</p>	<p>Other components on the shaft can be located axially against the bearing on its sleeve via spacer sleeves.</p> <p>Easy dismounting as the bearing inner ring is in contact with the stepped ring</p>
Applications	<ul style="list-style-type: none"> • Long shafts where more than two bearings are required for support • When the final position of the bearing cannot be accurately determined prior to mounting • When machine components are mounted using clamping or tensioning devices so that the shaft does not need to be machined 	<ul style="list-style-type: none"> • Support of shaft ends • Frequent mounting and dismounting

Table 8

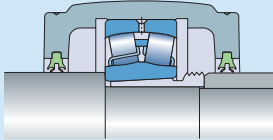

Stepped shaft with bearing on a withdrawal sleeve

- Machining required, typically two steps
- Shaft strength weakened by shoulders

- Bearing position determined accurately by the shaft shoulder
- Internal clearance changes during mounting (proper drive-up required)
- Axial load carrying capacity limited by the shaft sleeve or withdrawal sleeve in one direction and by the bearing and housing in the other direction

Other components on the shaft can be located axially against the bearing on its sleeve via spacer sleeves.

Easy dismounting with a withdrawal sleeve and hydraulic nut

- Support of shaft ends
- Frequent mounting and dismounting

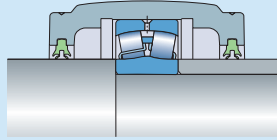

Stepped shaft with bearing on a cylindrical seat

- Machining required, typically two steps
- Shaft strength weakened by shoulders
- Largest shaft diameter for a given bearing size

- Bearing position determined accurately by the shaft shoulder
- Internal clearance determined by the shaft seat tolerance
- Axial loads carrying capacity limited by the bearing and housing

Other components can be located axially against the bearing via spacer sleeves

Suitable when large numbers of bearings have to be mounted

Simple axial locating by shaft nut

- Support of shaft ends
- Frequent mounting and dismounting
- Suitable for shock loads or where higher speeds or higher precision are required

Load carrying ability

The load carrying ability of a housing depends on many factors:

- the housing material and design and, where applicable, cap bolt strength
- the direction of the load
- the strength of the attachment bolts and support structure
- the condition of the support surface

SKF provides static housing load limits, either in the form of breaking loads or safe loads, for most housings. Where values are not provided, the load carrying ability is higher for the housing than for the bearing.

Breaking loads can be used to calculate a permissible load, based on a selected safety factor. Safe loads already include a safety factor.

Special attention is required for split housings subjected to cyclic loads or dynamic imbalance. Under these conditions, cap bolt and housing cap strength (P_{180°) should be analyzed carefully. For additional information, contact the SKF application engineering service.

Breaking loads

For most SKF housings, guideline values for the breaking loads P are provided in the relevant product chapter. To obtain the permissible load for a housing, the guideline value should be divided by a factor based on the safety requirements and operating conditions of the application. In general engineering, a safety factor of 6 is typical. The permissible load can only be exploited if the housing is mounted properly and all bolts are tightened to the specified torque values. For split housings, the strength of the cap bolts should also be considered. A minimum safety factor of 2 against cap bolt yield should be used.

The load P_a is the axial breaking load of the housing. If the incorporated bearing is mounted on a sleeve, check the permissible axial load for the sleeve (→ *Axial load carrying ability for bearings on a sleeve*).

Safe loads

In some regions, safe loads are used instead of breaking loads. These guideline values have been established using accepted engineering practices, taking safety and ultimate tensile strength of the materials into account. They reflect a safety factor of 5 against housing fracture, and where applicable, a minimum factor of 2 against cap bolt yield. The safe loads can only be fully exploited if the housing is mounted properly and all bolts are tightened to the correct torque values.

Axial load carrying ability for bearings on a sleeve

When using a bearing on a sleeve on a plain shaft, the axial load carrying ability is limited either by the bearing, sleeve or housing.

For the axial load carrying ability of the bearing, refer to the product information available online at skf.com/bearings. For the sleeve, the permissible axial load to safely prevent slippage on the shaft is determined by the friction between the shaft and sleeve. Provided the bearing is mounted correctly (→ skf/mount.com), the permissible axial load can be calculated from

$$F_{ap} = 0,003 B d$$

where

F_{ap} = maximum permissible axial load [kN]

B = bearing width [mm]

d = bearing bore diameter [mm]

Information about the axial load carrying ability of the housing is provided in the relevant product chapter.

Specifications for shafts and housing support surfaces

Shaft

Bearing seat

Recommended fits for bearings on solid steel shafts in cast iron housings are provided in the SKF catalogue *Rolling bearings* and are available online at skf.com/bearings.

If adapter or withdrawal sleeves are used, the sleeve seat on the shaft should be machined to tolerance class h9 $\text{\textcircled{E}}$ or better. The total radial runout should be IT5/2 for tolerance class h9 $\text{\textcircled{E}}$.

If bearings are to be mounted directly onto the shaft, the cylindricity tolerance and total runout tolerance of the bearing seat should, depending on the requirements, be one to two IT tolerance grades better than the prescribed dimensional tolerance. Abutments for bearing rings should have a perpendicularity tolerance and total axial runout tolerance that is at least one IT tolerance grade better than the diameter tolerance of the associated cylindrical seat.

Seal seat or counterface

Recommendations are provided in the relevant product chapter. Generally, seal counterfaces should be machined to tolerance class h9 $\text{\textcircled{E}}$ or better and the cylindricity should be to tolerance grade IT5.

Surface roughness

At the sleeve and seal positions, the shaft surface should have a surface roughness $R_a \leq 3,2 \mu\text{m}$ (125 $\mu\text{in.}$). Recommendations for the surface roughness of cylindrical bearing seats are provided in the SKF catalogue *Rolling bearings* and are available online at skf.com/bearings.

Housing support surface

To maximize bearing service life and prevent deformation of the housing bore, SKF recommends that the flatness of the housing support surface is to tolerance grade IT7 in accordance with ISO 1101. The surface should be finished to a surface roughness $R_a \leq 12,5 \mu\text{m}$ (500 $\mu\text{in.}$).

Lubrication

Grease selection

Grease selection is typically driven by the bearing and its operating conditions. The same grease can be used to fill the housing and lubricate the seal.

For information about SKF greases, refer to the product information available online at skf.com/lubrication. The SKF grease selection program *LubeSelect*, also available online at skf.com/lubrication, can be used to select an appropriate grease.

Biodegradable grease for housings with sealed bearings

If sealed bearings are used, the grease used to fill the housing and lubricate the housing seals does not need to be compatible with the grease inside the bearing. This is a good opportunity to use environmentally friendly grease such as SKF LGGB 2. It is a biodegradable, low toxicity grease. For additional information about this grease, refer to the product information available online at skf.com/lubrication.

Initial grease fill

If no other requirements exist, the free space in the bearing should be completely filled with grease and the free space in the housing should be filled to 20 to 40% of its volume. A 40% grease fill is required when bearings have to be relubricated from the side, while a 20% grease fill is used when bearings are lubricated via the outer ring.

For highly contaminated environments and slow speeds, fill the housing to 70 to 80%. For the best protection against contaminants, use the SKF three-barrier solution (→ page 39).

Higher speeds can require a reduced grease fill. For additional information, contact the SKF application engineering service. Quantities for the initial grease fill are provided in the individual product chapters.

Relubrication

Grease escape holes

Bearing arrangements in housings that have contact seals, e.g. double-lip or four-lip seals, can be equipped with a grease escape hole to allow used, excess grease to be purged from the housing. The escape hole should be positioned on the side opposite the grease inlet and if applicable, on the same side as the lock nut. For long relubrication intervals, it is often sufficient to remove the housing cap or cover and remove the old grease.

Relubrication via the outer ring

CAUTION: Care should be taken when relubricating spherical roller bearings in the non-locating position via their lubrication feature in the outer ring. There is a risk that the lubrication groove of the bearing will not be aligned with the hole in the centre of the housing cap and the lubricant will not reach the bearing. This can be the case when narrow bearings are mounted in housings with a wide housing seat, e.g. spherical roller bearings in the 222 series mounted in SNL 5(00) series housings, and the application is subjected to large axial movements. Under these circumstances, the bearings should be relubricated from the side.



Fig. 16

SKF tools and products

SKF has a wide assortment of lubrication tools and products for SKF bearing housings. A brief overview is provided here. For additional information, refer to the product information available online at mapro.skf.com and skf.com/lubrication.

Grease meter

The SKF grease meter LAGM 1000E (→ **fig. 16**) accurately measures grease discharge in volume or weight, and in both metric (cm^3 or g) and imperial (fl.oz. or oz.) units. It is suitable for all SKF bearing greases with a consistency class of up to 3 on the NLGI scale.

Automatic lubricators

Automatic lubricators can prevent both over and under-greasing.

SKF SYSTEM 24 lubricators (→ **fig. 17**) are automatic single point lubricators suitable for a wide range of applications and operating conditions. They are compact, easy to install and have a transparent container to check the amount of lubricant that is available. There are two series of lubricators: Gas driven lubricators include LAGD 60 (60 ml) and LAGD 125 (125 ml); Electro-mechanical driven lubricators include LAGE 125 (122 ml) and LAGE 250 (250 ml).

The SKF MultiPoint lubricator LAGD 400 (→ **fig. 18**) is a centralized automatic lubricator that simultaneously lubricates up to eight points. It is compact, easy to install and has a transparent container to check the amount of lubricant that is available.



Fig. 17



Fig. 18

SKF bearing housings – overview, selection and application recommendations

Oil levellers

SKF oil levellers LAHD 500 (→ **fig. 19**) and LAGH 1000 are designed to automatically adjust the oil level in a bearing housing. The levellers allow the oil level to be adjusted during operation, optimizing machine performance and increasing the service life of the bearings. The transparent container enables the oil level to be inspected.

Adapters to change connection threads

The assortment of adapters in the LAPN series (→ **fig. 20**) are available, to convert, for example, from a 1/8 – 27 NPSF thread to a G 1/4 thread.

Caps and tags for grease fittings

TLAC 50 caps and tags provide a space to properly identify the lubrication point(s) on a bearing housing as well as protect the grease fittings from the ingress of contaminants (→ **fig. 21**). The labels can also be used in conjunction with the SKF Lubrication Planner.

Centralized lubrication systems

The SKF Multilube pumping unit (→ **fig. 22**) is a compact, all-in-one unit for lubricating individual machines and equipment. Designed for indoor and outdoor use, the unit is suitable for all pumpable oils and greases and can be used in single line, dual line and progressive lubrication systems.



Fig. 21



Fig. 22



Mounting

Mounting instructions are supplied with most SKF bearing housings, or with the corresponding seal kit. For additional information about mounting, refer to the *SKF bearing maintenance handbook* or the information available online at skf.com/mount.

Preparations prior to mounting

Mounting housings (and bearings) requires care, accuracy and the appropriate tools. Prior to mounting, do the following:

- Make sure that the work area is clean.
- Study any drawings or instructions to determine the correct order in which to assemble the various components.
- Make sure that all the necessary components and tools are at hand.
- Clean the support surface.
- Check that the support surface meets the requirements for flatness (→ *Specifications for shaft and housing support surface*, page 45).
- Check that the shaft seats and seal counterfaces meet the requirements for dimensional and form accuracy, roughness and hardness (→ *Specifications for shaft and housing support surface*, page 45).
- Chamfer or round any shaft edges over which a seal lip will pass.

SKF tools and products

The SKF assortment of mounting tools and products includes mechanical tools, hydraulic tools, heating equipment and gloves. For additional information, refer to the product information available online at mapro.skf.com.

Lifting housings

Many SKF bearing housings are supplied with eye bolts for safe and easy handling. The eye bolts are designed to support the weight of the housing only, and not the incorporated bearing or shaft.

When lifting, make sure that the eye bolts are only subjected to load in the direction of the shank axis. The load should be evenly distributed across the number of eye bolts.

Attachment bolt tightening

Applying the specified torque to a bolt during installation is extremely important. Improper torque values can lead to machinery movement during operation. This can cause misalignment between machine parts, which will eventually lead to premature damage to bearings and other components.

Recommended tightening torque values are provided in the product chapters and are based on bolt manufacturers' recommendations.

All bolts should be tightened with an accurate torque wrench (in at least two stages) or a hydraulic bolt tensioner. SKF recommends using a HYDROCAM hydraulic bolt tensioner in applications where the attachment bolt has an end protruding above the tightening nut. These tensioners reduce the risk of over tightening and enable bolts to be installed accurately without the need of a torque wrench. The tensioners also provide uniform assembly preload or uniform bolt elongation.

Using shims

Shims can be used to raise the centre height of a housing. SKF recommends using shims made of stainless sheet steel with sufficient strength and the ability to withstand corrosion from several media. Shims made from soft metals like copper or brass typically compress over time, causing looseness, which can eventually lead to misalignment. Whenever possible, use only one shim and never stack more than three shims.

CAUTION: Make sure that the shim covers the complete contact surface between the housing base and the support surface (→ fig. 23). If shims are placed under the housing feet only, the bearing seat can distort.

Using locating (stabilizing) rings

A bearing in the locating position must be secured axially in the housing. If the bearing seat in the housing and the bearing width do not match, locating (stabilizing) rings (→ fig. 24) are required. Typically, two locating rings are required per housing. One ring should be placed on each side of the bearing. If only one locating ring is required, it should be installed on the same side as the lock nut. When placing

a locating ring in position, make sure that the open end of the locating ring is facing up.

CARB toroidal roller bearings, which are used exclusively in the non-locating position, require locating rings when the bearing seat in the housing and the bearing width do not match. For information about which locating rings are required for a bearing in a particular housing, refer to the relevant product chapter.

Installing seals

The seal counterface should meet the specifications for surface roughness and roundness (→ *Specifications for shaft and housing support surface*, page 45), and should be clean. If the counterface shows any signs of wear, repair it. This can be done easily with an SKF SPEEDI-SLEEVE or a large diameter wear sleeve (LDSLVL). If repair is not possible, replace the shaft.

In general, the seal and counterface should be coated lightly with the lubricant used in the application.

When installing seals, make sure that the seal is oriented correctly. Many seals are not symmetrical and can be installed to either exclude contaminants or retain the lubricant.

Split seals consist of two halves, which can be installed around the shaft. They are easier to replace and can ease mounting.

Felt seals should be soaked in hot oil prior to installation.

Fig. 23

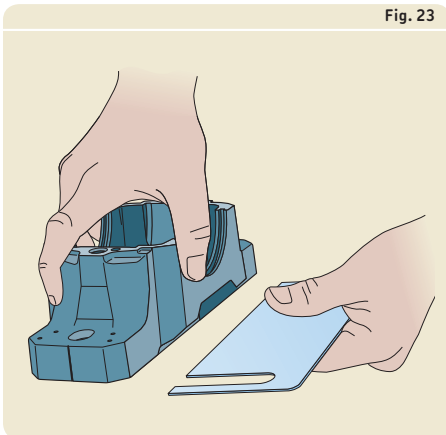
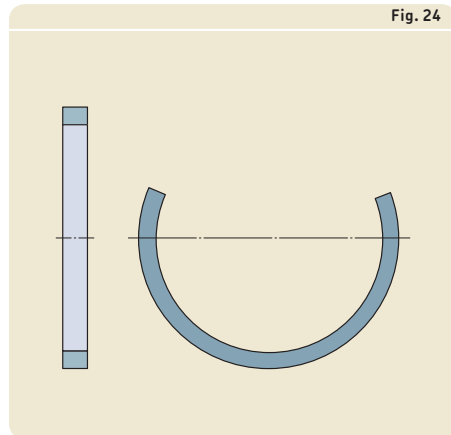

Fig. 24



Inspection and condition monitoring

SKF housings and roller bearing units should be inspected regularly for damage and lubricant leaks. SKF also recommends a visual inspection of the seals, plugs, bolts and housing joints. The frequency of these inspections depends on the operating conditions and potential downtime consequences but should be done as part of a regularly scheduled maintenance program.

Where oil bath lubrication is used, the oil level should be monitored regularly. During operation, the oil level may drop below the minimum level. If that should happen, and oil needs to be added while the machine is running, keep the oil level well below the maximum oil level on the indicator or overfilling can result.

For additional information about inspection techniques and corrective maintenance actions, refer to the *SKF bearing maintenance handbook*.

SKF also recommends monitoring the condition of all bearings on a regular or continuous basis to detect early signs of bearing damage. Trending the condition of the bearing makes it possible to analyze the root cause of an impending failure, and plan for corrective action. Trending can also eliminate unplanned downtime. The most reliable way to do condition monitoring is through vibration analysis.

Vibration analysis

Many SKF housings are prepared for condition monitoring and are supplied with drilled and tapped holes to accommodate sensors. For other housings, dimples indicate the position where sensors can be located. For information about the condition monitoring possibilities for a particular housing type, refer to the relevant product chapter.

SKF has a comprehensive assortment of vibration detection, analysis and diagnostic products, from light hand-held instruments to fully integrated monitoring systems. For additional information, refer to the product information available online at skf.com/cm.

Storage

SKF housings, roller bearing units and associated components, including the seals, should be stored under controlled temperature and humidity conditions in a clean, dry environment. Variations in temperature and humidity should be avoided but gradual, seasonal variations of a gradual nature are acceptable. As a general rule, SKF recommends the following storage conditions:

- temperature: < 30 °C (< 85 °F) for long-term storage
- relative humidity: < 60%
- If peaks above 65% occur regularly, a dehumidifier is required.
- temperature fluctuation: max 3 °C/48 hours

Under these conditions, housings can be stored for up to 10 years. Roller bearing units should not be subjected to vibration during storage as this could cause false brinelling damage to the bearing. Depending on the actual storage conditions, the lubricating properties of the initial grease fill might deteriorate. Generally SKF roller bearing units should not be stored for more than 3 years.

