

SKF VectoLub, VTEC units

Compact and modular system for external minimal quantity lubrication,
Volumetric metering



The eMQL system SKF VectoLub is a clean and economical alternative for lubricant projection in minimal quantity.

The SKF VectoLub system works with volumetric micropumps, which deliver very small quantities of lubricant (starting at 3 mm³) at a high frequency to the friction point by the use of a bi-fluid projection nozzle. This system is used for:

- Machining, drawing, sawing,
- Lubricant coating,
- Conveyors lubrication,
- Fluid metering, ...

The VTEC units of the SKF VectoLub product family is a full modular eMQL system. The user can create its own eMQL system according to his specific needs and retrofit it at any time when necessary.

Advantages

- Higher machining performance (higher speeds when cutting and parting).
- Better surface finish thanks to lower (friction-induced) temperature.
- Long tool life, mainly when high-frequency machining is involved.

- Exact adjustment of delivery rate saves lubricant.
- Greater safety and environmental hygiene at the workplace. No mist, clean air to breath.
- Full modular system; retrofit table at any time.
- All outer connections are easy to release by the use of quick connectors.

The SKF VectoLub technology

The SKF VectoLub technology has proved itself for many years. It is based on the combination of very small quantity of lubricant (3 to 90 mm³), fed by pneumatically actuated volumetric micropump, and a flow of compressed air called “carrier air”.

Lubricant and carrier air are parallel conducted in an coaxial line to a bi-fluid spraying nozzle. The air is swirled in the nozzle and breaks down the lubricant into microdroplets (200 to 600 µm) at the nozzle outlet. The

lubricant microdroplets are transported by the carrier air to the friction point to generate a fine and homogeneous lubricant film oil without mist formation.

This technology optimizes the lubrication efficiency, reduces the consumption of lubricant and preserves the safety and cleanliness of the working area.

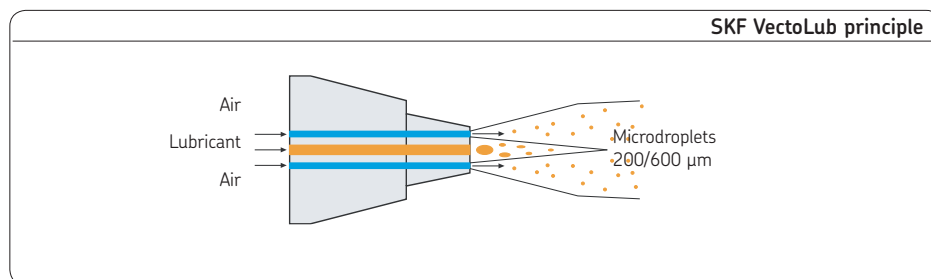

The VTEC unit

AVTEC unit is a modular unit comprising several elements, which are named modules. These modules are fitted with a micropump in order to supply a lubrication point each. Thanks to this modularity the user can easily adapt the lubrication system to its needs. So he can:

- independently adjust the flow rate of every micropump to better meet the need of every lube point.
- pneumatically or electrically (with a control unit) control the operation of one or several micropumps at the same time. When adjusting the working frequency of the micropump, the user regulates the lubricant total flow rate.
- independently control several lubrication circuits (air inlet separately controlled) and thus lubricate with the same system different machines.
- monitor the lubricant outflow of a module.

The module

AVTEC unit can have up to 8 modules and therefore lubricate up to 8 lube points. Every module is selected according to the specific requirements of every lubrication point. Three main components are taken into account:

- the base
- the micropump
- the air flow monitoring

Setup

When the modules have been selected and composed, they are first assembled together and then mounted on standard fixation rail by means of fixing clips, which are on the back side of the modules. Therefore it is possible to install the VTEC unit directly on the machine frame in a protected area (no chips projection or other things), in the user's control cabinet or in one of our protection housings.

- fixing rail (page 14)
- protection boxes (pages 14 and 15)

All control and monitoring devices are on the front side of the unit.

Connection of the fluid lines

All outer fluid connections are made with quick-release connectors and therefore it is very easy to install the VTEC unit. General air inlet (carrier air and air for the micropumps) and lubricant inlet are on the left side of the first module of the VTEC unit. The reservoir has to be located upon the unit. Every module has on the top an outlet port for coaxial line (air + lubricant) to feed a lubrication point.

Components, please refer to the brochure 1-4402-EN *SKF VectoLub, accessories*

See important product usage information on the back cover.
See operating instruction 951-130-441.

Function

A VTEC unit has two inlet ports for on the one hand compressed air (5 to 8 bars), and on the other hand for lubricant (oil) coming from an external reservoir.

Air and lubricant are fed through all the modules of the VTEC unit. Every module has a pneumatic micropump and an outlet port for coaxial line.

Every pneumatically actuated micropump (max. pump frequency 3 pulses/s) delivers the lubricant (starting at 3 mm³/pulse) through the inner capillary tube of the coaxial line into a bi-fluid projection nozzle.

The low-pressure carrier air conducted through the tube is swirled in the nozzle. As a result, the metered quantity of oil is broken down into microdroplets, which are transported by the carrier air to the friction point without causing any mist.

The purpose of the projection nozzle is to generate tiny droplets of lubricant in the desired size and direct them to the lube surface with the help of carrier air.

The shape and size of the lubrication pattern are determined by the shape and dimensions of the individual nozzle openings. The nozzle are designed to assure appropriate flow velocities and trouble-free outflow. For example, the air is swirled in a certain zone so that the lubricant droplets are split into microdroplets.

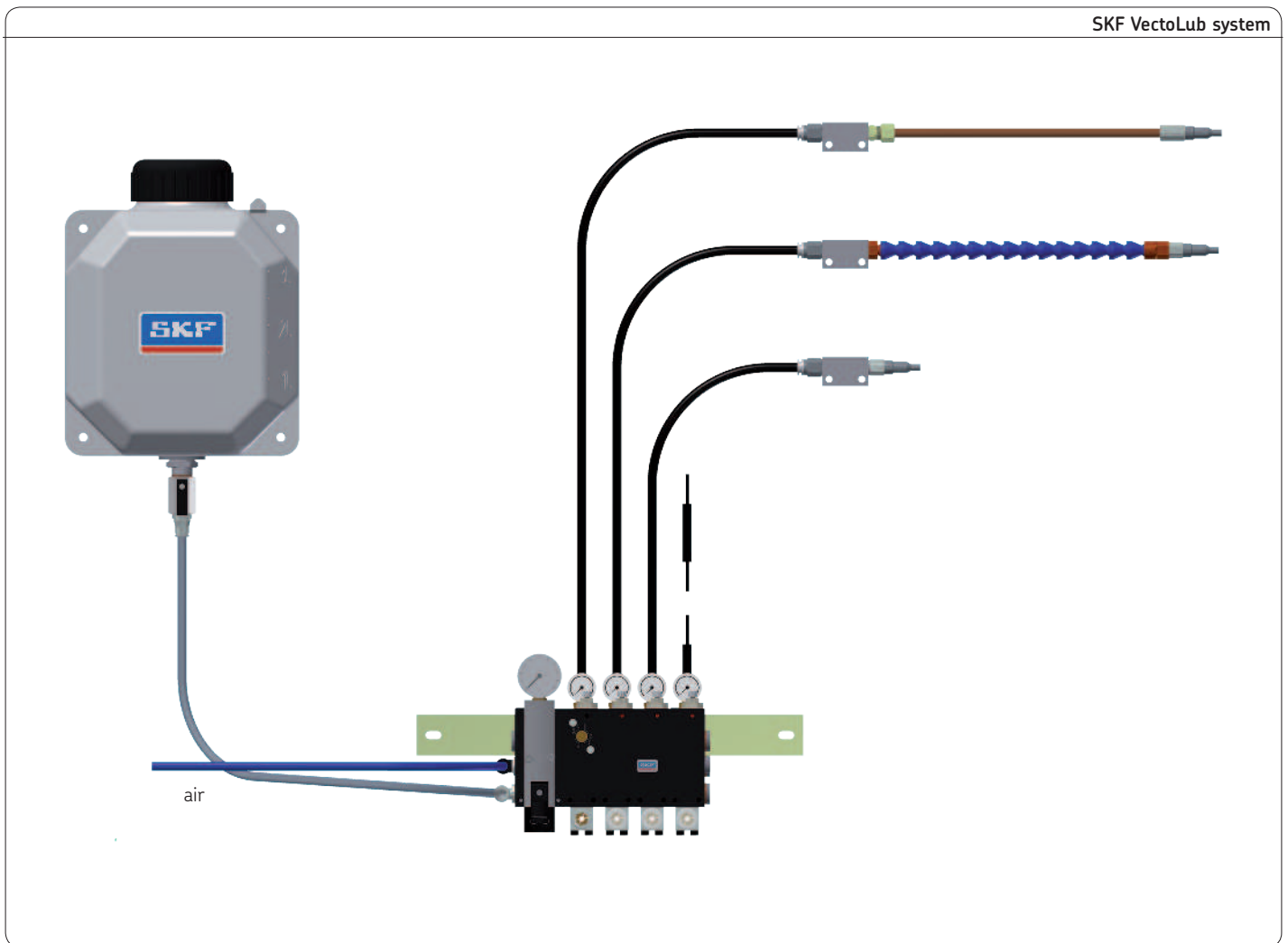

VTEC unit, component: the base

The first component of a VTEC unit module is the base. There are 10 different kind of bases, which supply lubricant to the friction point and a special base, which controls the air inlet for all other bases.

Common technical data

A base has an outlet port for coaxial line using quick-release connectors. It also has flow regulator to control the carrier air flow at the outlet.

Specific technical data

A base can have other elements, which confer to it various functions:

- control the air inlet
- control the working frequency of the micropump
- monitor the micropump flow rate

Air inlet control

General air solenoid valve

The general air solenoid valve controls the air inlet for the whole unit – micropump control air and carrier air. The base (I), equipped with the solenoid valve is always master of the downstream bases for this function.

Micropump working frequency

Air solenoid valve

The air solenoid valve controls the micropump. The micropump working frequency is adjusted by the solenoid valve, which is controlled by a control unit.

Pneumatic pulse generator

The pulse generator adjusts the working frequency of the micropump. A base with an air solenoid valve, positioned upstream, controls the air inlet, which actuates the micropump.

Air solenoid valve + pneumatic pulse generator

The air solenoid valve controls the micropump and the pulse generator adjusts the working frequency of the micropump.

Flow monitoring

Lubricant flow sensor GS304P

The flow sensor GS304P monitors the lubricant outflow of the micropump.

Caution!

Bases with the flow sensor GS304P only works with an operating voltage of **24 V DC**
The working frequency of the flow sensor GS304P is **max. 4 cycles per minute**

Base codification

Code	A	B	C	D	E	F	G	H	I	J	K
Carrier air regulator	•	•	•	•	•	•	•	•		•	•
Pneumatic pulse generator		•		•		•		•			
Air solenoid valve			•	•			•	•			
Lubricant flow sensor					•	•	•	•			•
Micropump	•	•	•	•	•	•	•	•		•	•
General air solenoid valve									•		
Module unit	1	1	1	1	2	2	2	2	1	1	2
Width [mm]	30	30	30	30	60	60	60	60	42	30	60
Voltage 115 V AC 50/60 Hz			•	•					•		
Voltage 230 V AC 50/60 Hz			•	•					•		
Voltage 24 V DC			•	•	•	•	•	•	•		•

Possible configurations

The modular construction of the VTEC unit makes it possible to gather together different modules feeding different lubrication points. A module can have either its own function parameters (micropump actuation, pump working frequency, air flow) or similar parameters with other modules. Then a module can control one or several other module(s), which are located downstream. The controlling module is then called "master" and the controlled module "slave".

It is also possible to feed different and independent lubrication circuits with the same VTEC unit.

These criteria are very important for the selection of the modules and above all for the selection of the bases with their proper functions.

Single circuit and multi-circuits

Unit for a single lubrication circuit

One or several modules are working simultaneously: put a module with a general air solenoid valve (base I) upstream all the other modules with micropumps.

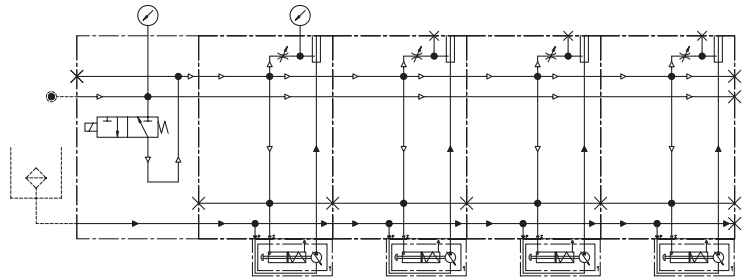

Unit for several lubrication circuits

One or several modules are working according to different cycles: put a module with a general air solenoid valve (base I) upstream the modules corresponding to one circuit and working independently from the others.

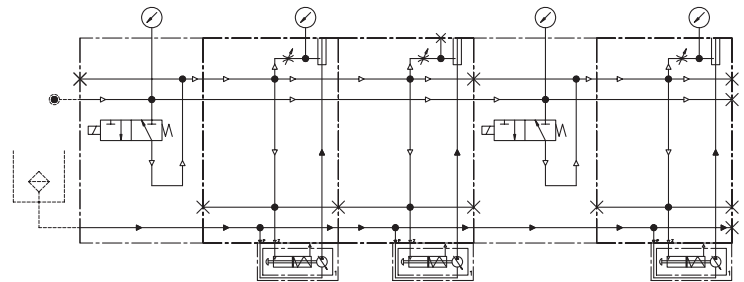

Bases

Base I

Special base. Compared to the other bases, it does not supply a lubrication point (no air regulator, no micropump). It is equipped with a general air solenoid valve.

The air general solenoid valve controls the air inlet for the pneumatic micropumps as well as the carrier air inlet. This base is always master of the other bases which are placed downstream.

This is a very important base for the VTEC unit, as it makes it possible to have several and fully independent lubrication circuits with one unit.

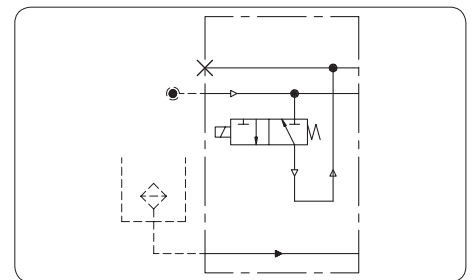
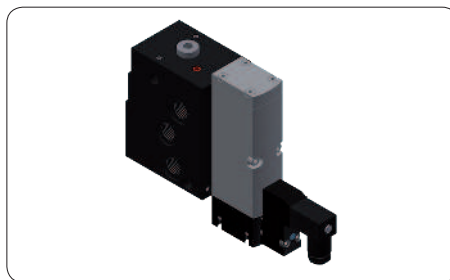

Base A

- Slave module

This base has no additional function. It is always used as slave of the base positioned upstream.

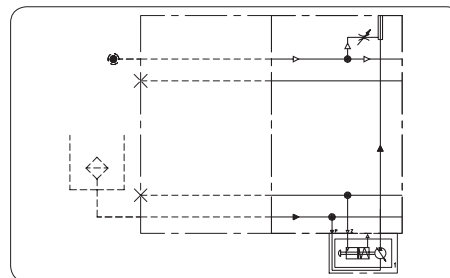

Base B

- Pneumatic pulse generator

The pulse generator adjusts the working frequency of the micropump. A base with an air solenoid valve, positioned upstream, controls the air inlet, which actuates the micropump.

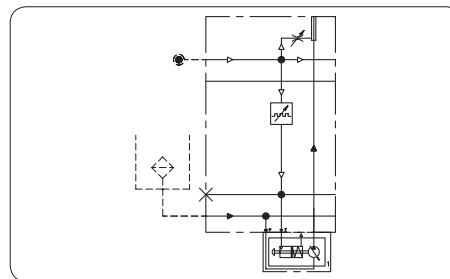
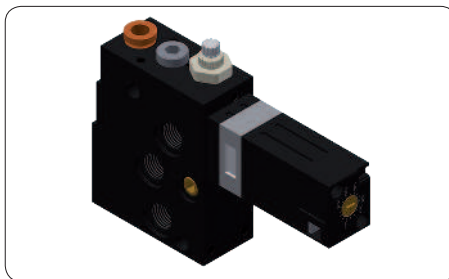

Base C

- Air solenoid valve

The air solenoid valve controls the micropump. The micropump working frequency is adjusted by the solenoid valve, which is controlled by a control unit.

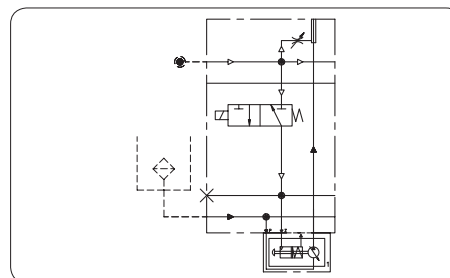
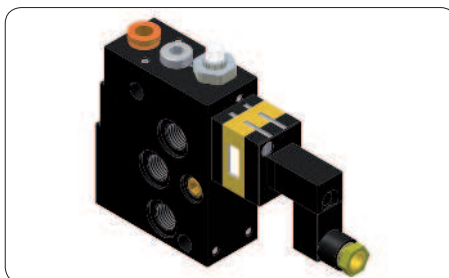

Base D

- Air solenoid valve
- Pneumatic pulse generator

The air solenoid valve controls the micropump and the pulse generator adjusts the working frequency of the micropump.

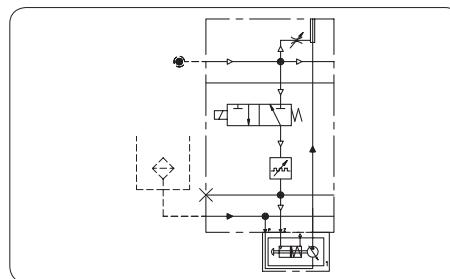

Base J

- Slave module

This base has no additional function. It is always controlled by a base positioned upstream with an air general solenoid valve (base I).

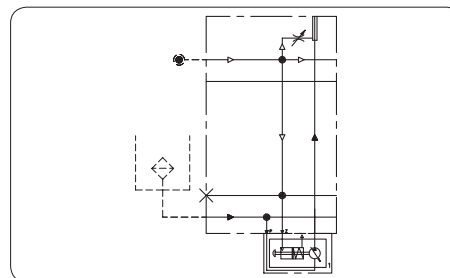
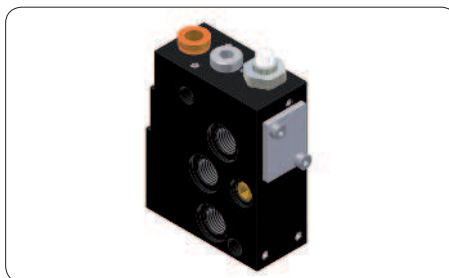

Base E

- Lubricant flow sensor GS304P

The flow sensor GS304P monitors the lubricant outflow of the micropump. This base has no other additional function. It is always used as slave of the master base positioned upstream.

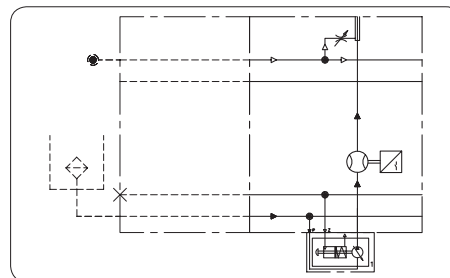
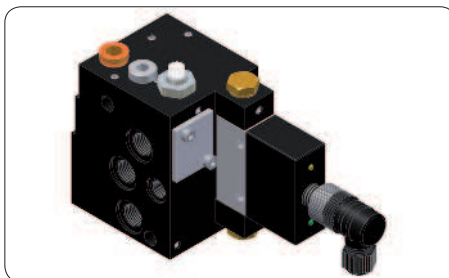

Base F

- Pneumatic pulse generator
- Lubricant flow sensor GS304P

The pulse generator adjusts the working frequency of the micropump. A base with an air solenoid valve, positioned upstream, controls the air inlet, which actuates the micropump. The flow sensor GS304P monitors the lubricant outflow of the micropump.

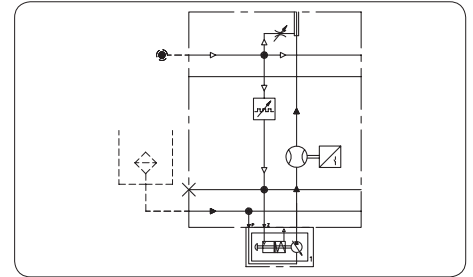
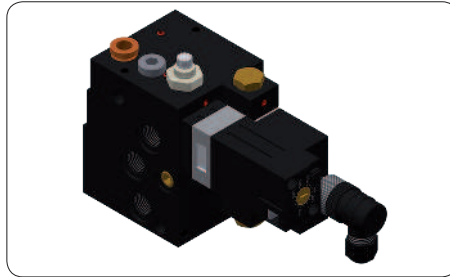

Base G

- Air solenoid valve
- Lubricant flow sensor GS304P

The air solenoid valve controls the micropump. The micropump working frequency is adjusted by the solenoid valve, which is controlled by a control unit. The flow sensor GS304P monitors the lubricant outflow of the micropump.

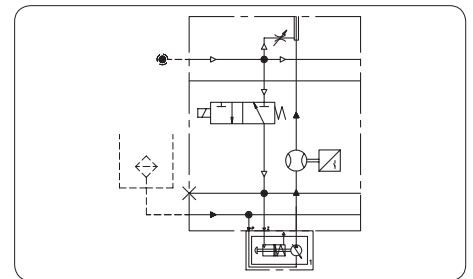
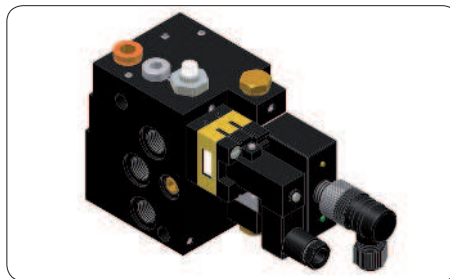

Base H

- Air solenoid valve
- Pneumatic pulse generator
- Lubricant flow sensor GS304P

The air solenoid valve controls the micropump and the pulse generator adjusts the working frequency of the micropump. The flow sensor GS304P monitors the lubricant outflow of the micropump.

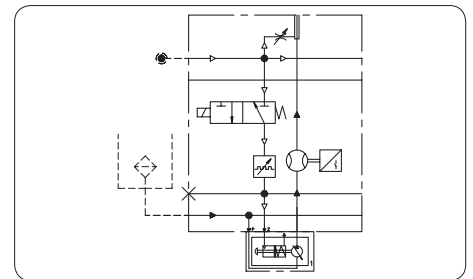
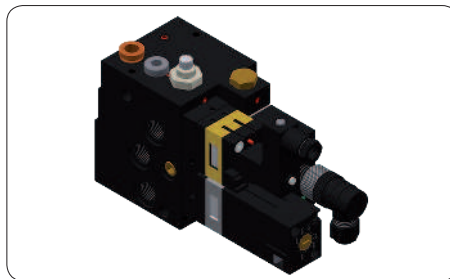

Base K

- Slave module
- Lubricant flow sensor GS304P

This base has no additional function. It is always controlled by a base positioned upstream with an air general solenoid valve (base I). The flow sensor monitors the lubricant outflow of the micropump.

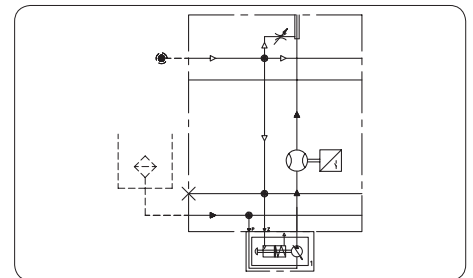
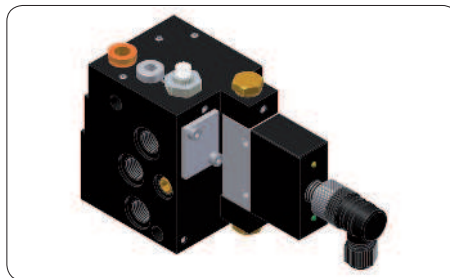

VTEC unit, component: the micropump

Every base is equipped with a micropump that delivers a metered quantity of lubricant to the friction point.

Three criteria have to be taken into account to select a micropump according to the application.

- Flow range
- Flow rate adjustment
- Micropump material

Flow range

Two ranges of flow rate are available:

- **small flow:** 3 to 30 mm³/stroke (setting with metering ring) or 10 to 30 mm³/stroke (setting with thumb wheel),
- **large flow:** 30 to 90 mm³/stroke (setting with metering ring or thumb wheel)

The flow rate is given in mm³ for one piston stroke, and the final lubricant outflow, which is necessary for the application, depends on the micropump working frequency.

Flow rate adjustment

- **Thumb wheel:** for the small flow, a thumb wheel turn corresponds to a change of the outflow of 5 mm³/stroke; for the large flow 15 mm³/stroke. It is possible to jam the outflow and a minimal flow is guaranteed with at least 2 complete wheel turns.
- **Metering rings:** for the small flow there are 6 metering rings (0/3/5/10/15/20) and for the large flow 4 metering rings (0/30/45/60). To get the maximal flow rate for every micropump, which is 30 mm³ for small flow and 90 mm³ for large flow, the user puts no metering ring.

Micropump material

According to the surrounding conditions, the micropump material can be an important criterion for the selection. Micropumps are available in **brass** or **stainless steel**.

		Micropump codification							
Code		A	B	C	D	E	F	G	H
Flow rate [mm ³ /stroke]	3 to 30	•		•					
	10 to 30		•		•				
	30 to 90					•	•	•	•
Setting	rings	•		•		•		•	
	thumb wheel		•		•		•		•
Material	brass	•	•			•	•		
	stainless steel			•	•			•	•



Function principle

Micropump

1. Lubricant outlet
2. Lubricant inlet
3. Compressed air supply
4. Metering ring
5. Valve
6. Lubricant metering chamber
7. Hydraulic piston
8. Spring
9. Air chamber
10. Pneumatic piston

1. Air is fed up under pressure via the air channel (3). It fills the air chamber (9) and pushes the control piston (10).
2. The metering ring (4) limits the control piston (10) stroke. As the metering piston (7) is mechanically linked to the control piston (10) it compresses the lubricant inside the chamber (6). The valve (5) opens and the lubricant is pushed out the chamber (6) to the outlet (1).
3. The chamber (9) is not any longer under pressure till the air inlet is shut off. The return spring (8) presses back the pistons (10 and 7) to their initial position. Then the chamber (6) is filled up with lubricant by gravity, which is delivered from the lubricant inlet (2).

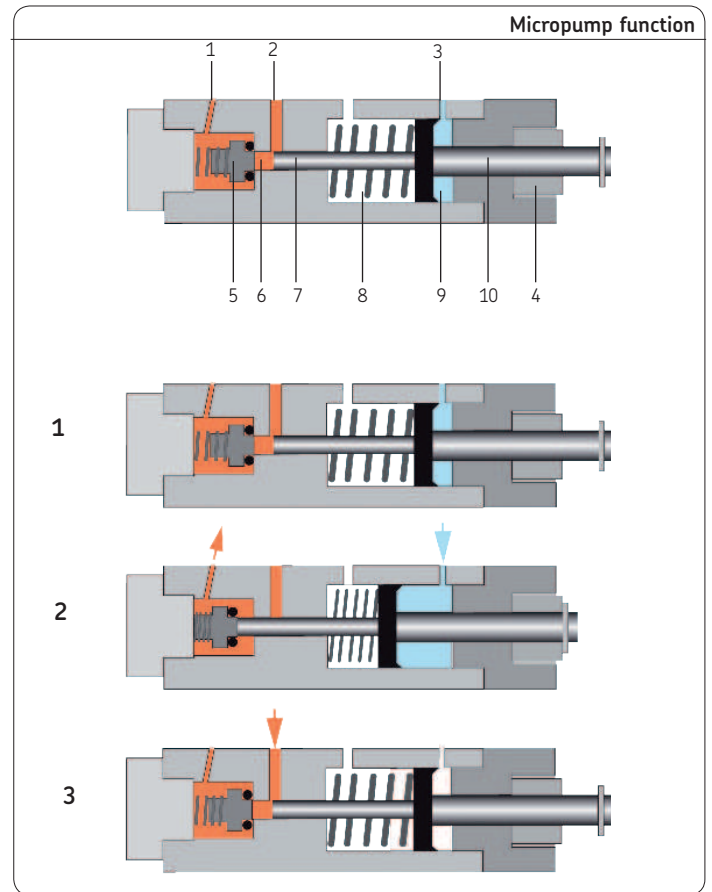

VTEC unit, component: air monitoring

The carrier air pressure of every module can be monitored independently. This is the third component of a module. With the air monitoring device, the user can optimize the carrier air outflow, which he adjusts at any time with the air flow regulator.

This component is on the top of the module.

Two monitoring types are available:

- Visual monitoring with manometers, pressure range from 0 to 4 bars
- Electrical monitoring with pressure switch, switching pressure 0,3 bar.

If no monitoring device is used on the module, the port is closed with a screw plug.

The special base I has any air flow regulator. Meanwhile it is possible to monitor the air flow. The two same monitoring devices are available. The setting ranges are different.

- Visual monitoring with manometers, pressure range from 0 to 10 bars
- Electrical monitoring with pressure switch, switching pressure 5 bars.

If no monitoring device is used on the module, the port is closed with a screw plug.

Air monitoring codification

Code	M	P	Z
Manometer	•		
Pressure switch		•	
No monitoring			•

Technical data

General

Number of modules	1 to 8
Compressed air	
Min. air inlet	800 NI/min
dry and filtered air (5 µm)	
Air inlet pressure	5 to 8 bars
Micropump flow rate	
Metering ring (small flow)	3 to 30 mm ³ /stroke
Metering ring (large flow)	30 to 90 mm ³ /stroke
Thumb wheel (small flow)	10 to 30 mm ³ /stroke
Thumb wheel (large flow)	30 to 90 mm ³ /stroke
Max. pump working frequency	3 strokes/s
Lubricant	mineral or synthetic oil, ecological oil
Effective viscosity	10 to 400 mm ² /s
(at operating temperature)	
Service temperature	10 to 50 °C
Fixing rail	EN 50035 or EN 50022

General air solenoid valve (base I)

Delivery rate (at 6 bars)	950 NI/min
Power supply	115 V – 50/60 Hz – 2 VA (1,5 W) 230 V – 50/60 Hz – 2 VA (1,5 W) 24 V DC – 1,6 W
Protection	IP 65
Interface	ISO size G01
Mechanical life	1,5 × 10 ⁶ switching operations

Pressure switch

Switching capacity	100 VA
Protection	IP65
Voltage max.	42 V
Mechanical life	1 × 10 ⁶ switching operations

Solenoid valve (electric pulse generator)

Delivery rate (at 6 bars)	150 NI/min
Power supply	115 V – 50/60 Hz – 2,5 VA 230 V – 50/60 Hz – 2,5 VA 24V DC – 1 W
Protection	IP 65
Interface	logic element
Mechanical life	1,5 × 10 ⁷ switching operations

Pneumatic pulse generator

Delivery rate (at 6 bars)	170 NI/min
Mechanical life	>1 × 10 ⁷ switching operations
Frequency	0,166 to 3 Hz

Lubricant flow sensor GS304P

Suitable for metered quantities from	10 to 600 mm ³
Max. working frequency	4 pulses/min
Lubricant viscosity	10 to 400 mm ² /s
Rated voltage	24 V DC
Load current IA	500 mA maxi per outlet

Pressure switch wiring

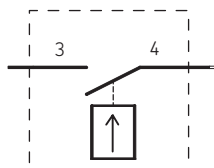

Flow sensor wiring

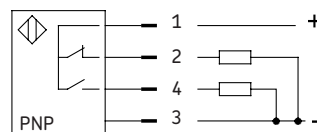

Pin 1 (BN – brown): + 24 V
 Pin 2 (WH – white): PNP/NC – opens in event of flow
 Pin 3 (BU – blue): 0 V
 Pin 4 (BK – black): PNP/NC – closes in event of flow

Recommended lubricant

The VTEC system can deliver mineral or synthetic oil, ecological oil, with an effective viscosity between 10 and 400 mm²/s at operating temperature. Vanishing lubricants have to contain 5 to 10% of greasy substance. A list of authorized lubricants is available on the website: www.skf.com/lubrication.

VTEC unit, dimensions

The dimensions of a VTEC unit depend on the number of modules.

According to their components, the modules come in different sizes. The modules with the bases A/B/C/D/J are 30 mm wide and occupy the space of one "module unit". The modules with the bases E/F/G/H and K are 60 mm wide and occupy the space of one "module unit". The module with the special base I is 42 mm wide and occupies the space of one "module unit".

Component	Type	Width [mm]	Module unit
Base	A / B / C / D / J	30	1
	E / F / G / H / K	60	2
	I	42	1

VTEC dimensions

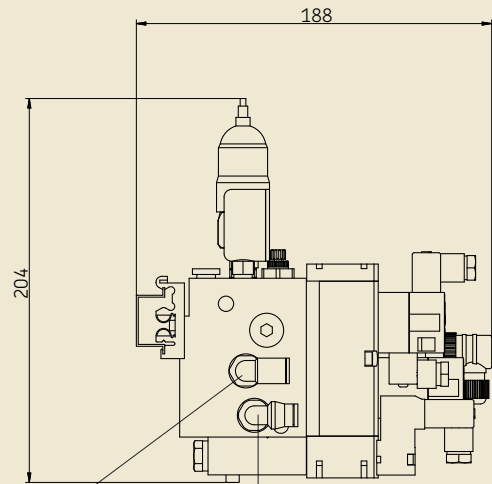
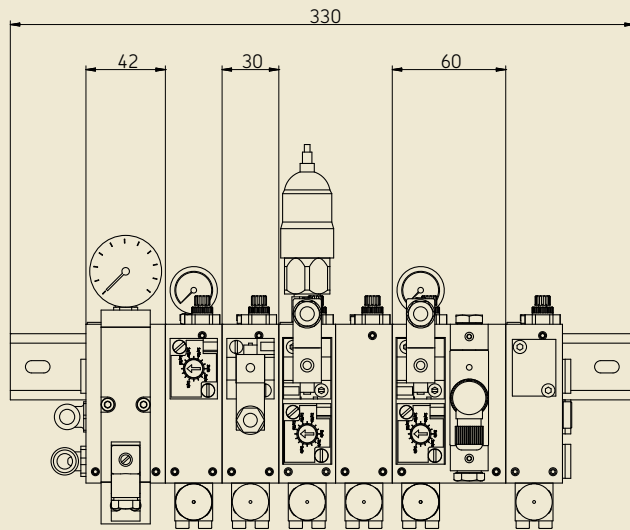

air inlet,
quick-release coupling for tube OD 8 mm

lubricant inlet,
quick-release coupling for tube OD 8 mm

Order information for a VTEC unit

It is a three-steps procedure to get the codification of a VTEC unit.

1/ Specification for every lubrication point of the corresponding module

The reference of a module comprises 3 letters, each letter corresponding to one component. Please refer to page 13 with the summary tables for every component.

- First letter: selected base
- Second letter: selected micropump
- Third letter: selected air monitoring device

Example: a module with the 'BBM' reference comprises a base with a pneumatic pulse generator (B), a micropump made of brass for small outflow (10 to 30 mm³/stroke) adjustable with a thumb wheel (B) and a manometer to monitor the carrier air outflow (M).

2/ Specification of the module assembly order. The module assembly order depends on the number of lubrication circuits and the control mode for each module.

The control of selected functions (master or slave) is determined by the position of the module in the VTEC unit and the upstream modules (air and lubricant inlets are on the left side of the VTEC unit).

3/ Power supply

The codification of the VTEC unit has to be completed with the voltage key corresponding to the power supply (please see page 10): +924/+428/+429

Note: if a base with a flow sensor GS304P or an electric monitoring device (pressure switch) has been selected, then the operating voltage for the whole VTEC unit has to be 24 V DC (voltage key +924).

Every SKF VectoLub unit is systematically delivered with quick connectors for air and lubricant inlets, as well as a specific tool to easily dismount the coaxial line.

Note!

When defining a VTEC unit, please take into account that a unit cannot have more than eight "module units" for dimension reasons. Some modules (bases A, B, C, D, I and J) correspond to one "module unit", when the others (bases E, F, G, H and K) correspond to two "module units".

Codification example of a VTEC unit

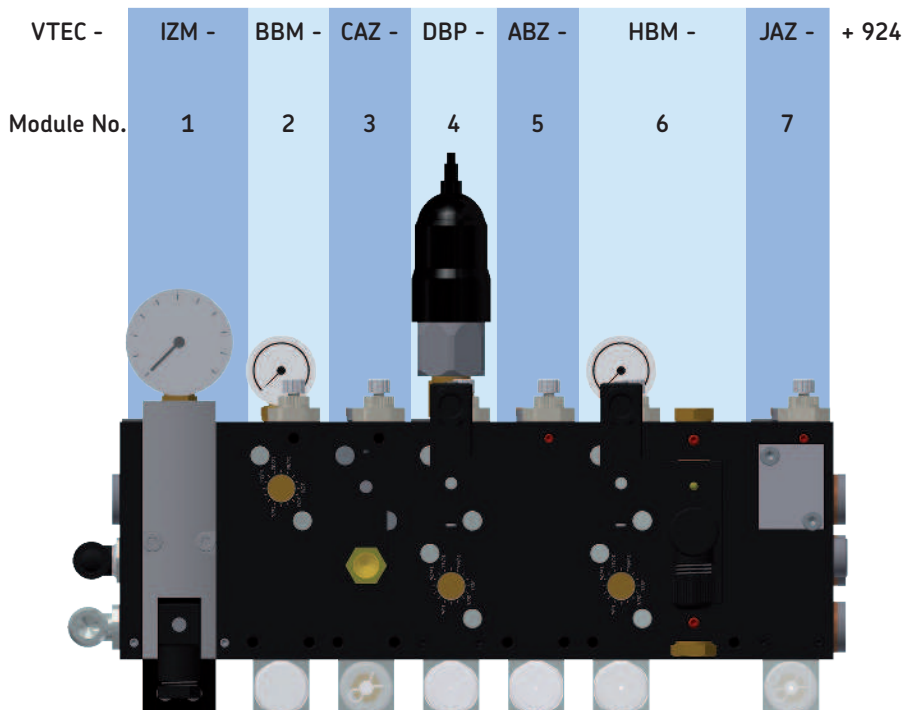

Summary tables of the different module components

1st component: the base

Code	A	B	C	D	E	F	G	H	I	J	K
Carrier air regulator	•	•	•	•	•	•	•	•		•	•
Pneumatic pulse generator		•		•		•		•			
Air solenoid valve			•	•			•	•			
Lubricant flow sensor					•	•	•	•			•
Micropump	•	•	•	•	•	•	•	•		•	•
General air solenoid valve									•		
Module unit	1	1	1	1	2	2	2	2	1	1	2
Width [mm]	30	30	30	30	60	60	60	60	42	30	60
Voltage 115 V AC 50/60 Hz			•	•					•		
Voltage 230 V AC 50/60 Hz			•	•					•		
Voltage 24 V DC			•	•	•	•	•	•	•		•

2nd component: the micropump

Code		A	B	C	D	E	F	G	H
Flow rate [mm ³ /stroke]	3 to 30	•		•					
	10 to 30		•		•				
	30 to 90					•	•	•	•
Setting	rings	•		•		•		•	
	thumb wheel		•		•		•		•
Material	brass	•	•			•	•		
	stainless steel			•	•			•	•

3rd component: air monitoring

Code	M	P	Z
Manometer	•		
Pressure switch		•	
No monitoring			•

VTEC unit, fixation mode

Fixing rail

The VTEC unit can be directly mounted in the user's control cabinet or on the machine frame – protected from chips projection or others – by the use of a standard fixing rail (fixation clips are delivered with the module).

- For 2 to 8 module units.
- Rails are in processed steel and meet EN standards.

Fixing rail order no.

Order No.	Max. number of module units	Dimension L × H × P [mm]
SY.9663.105	2	105 × 35 × 15
SY.9663.180	4	180 × 35 × 15
SY.9663.330	8	330 × 35 × 15

Fixing rail

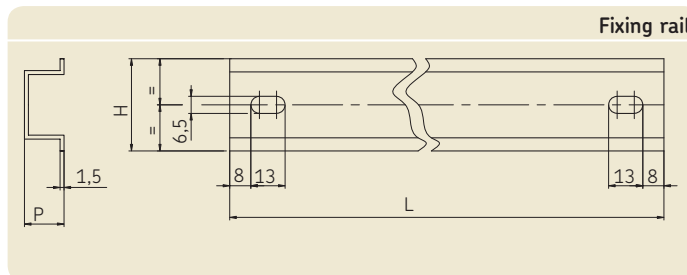

Protection housing

Protection housing have been especially designed for VTEC units. They are for either max. 4 "Module units" or max. 8 "Module units".

The housing are either in steel, thickness 15/10, or in stainless steel, thickness 15/10. Hoses and cables are connected to the VTEC unit via cable glands:

- Fluid inlets (air and lubricant) on the left side,
- Coaxial outlets on the right side,
- Electrical connections on the upper side.

Stainless steel housing have a door with glass to visually check the air monitoring devices and the good function of the unit. Holders have been integrated inside the housing to put the unused metering rings and the dismantling tool for coaxial hoses.

Protection housing

Order No.	Max. number of module units	Material / Color	Glas door	Protection	Service temperature [°C]
Standard protection housing, electric terminal bar, pressurized air inlet filter.					
MOD-052	4	steel / RAL 7032	–	IP55	10 to 50
MOD-054	4	stainless steel	•	IP55	10 to 50
MOD-053	8	steel / RAL 7032	–	IP55	10 to 50
MOD-055	8	stainless steel	•	IP55	10 to 50
Simple protection housing, no electric terminal bar, no pressurized air inlet filter.					
MOD-0525	4	steel / RAL 7032	–	IP55	10 to 50
MOD-0535	8	steel / RAL 7032	–	IP55	10 to 50

MOD-052 / MOD-054

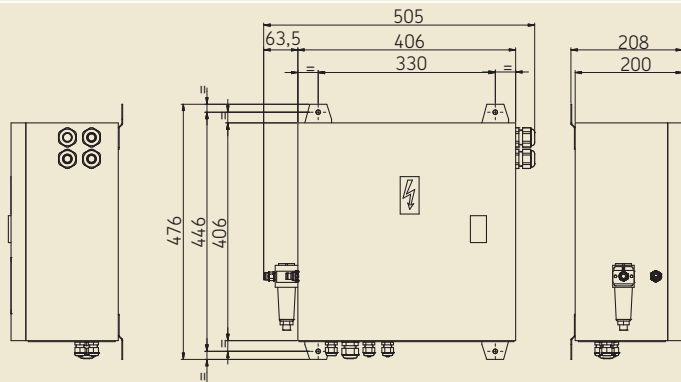

MOD-053 / MOD-055

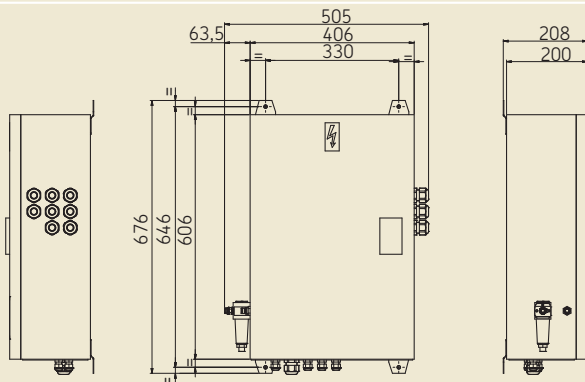

MOD-0525

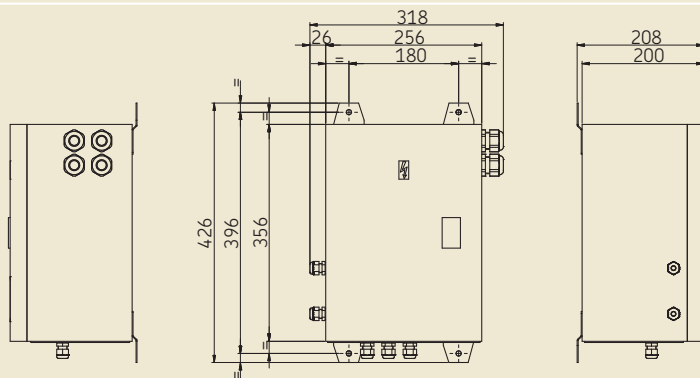

MOD-0535

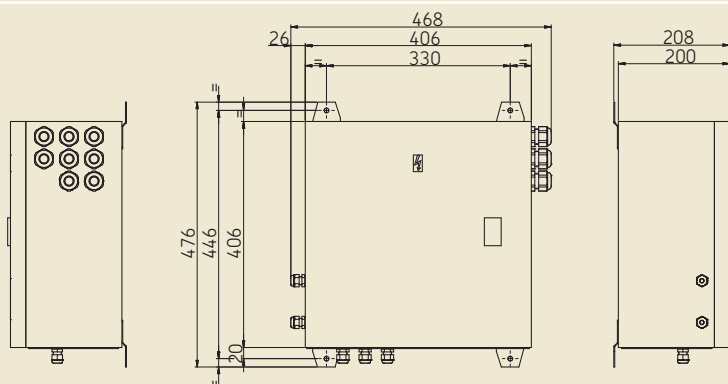

Order No.: 1-4401-EN

Subject to change without notice! (10/2015)

Important product usage information

All products from SKF may be used only for their intended purpose as described in this brochure and in any instructions. If operating instructions are supplied with the products, they must be read and followed.

Not all lubricants are suitable for use in centralized lubrication systems.

SKF does offer an inspection service to test customer supplied lubricant to determine if it can be used in a centralized system. SKF lubrication systems or their components are not approved for use with gases, liquefied gases, pressurized gases in solution and fluids with a vapor pressure exceeding normal atmospheric pressure (1013 mbars) by more than 0,5 bar at their maximum permissible temperature.

Hazardous materials of any kind, especially the materials classified as hazardous by European Community Directive EC 67/548/EEC, Article 2, Par. 2, may only be used to fill SKF centralized lubrication systems and components and delivered and/or distributed with the same after consulting with and receiving written approval from SKF.

Further brochures:

1-9201-EN Transport of Lubricants in Centralized Lubrication Systems

This brochure was presented by:

® SKF and VectoLub are a registered trademarks of the SKF Group.

© SKF Group 2015

The contents of this publication are the copyright of the publisher and may not be reproduced (even extracts) unless prior written permission is granted. Every care has been taken to ensure the accuracy of the information contained in this publication but no liability can be accepted for any loss or damage whether direct, indirect or consequential arising out of the use of the information contained herein.

