



PTFE seals for screw compressors

Customized and off-the-shelf sealing solutions from SKF



The Power of Knowledge Engineering

If you know SKF just for bearings,
you only know half the story

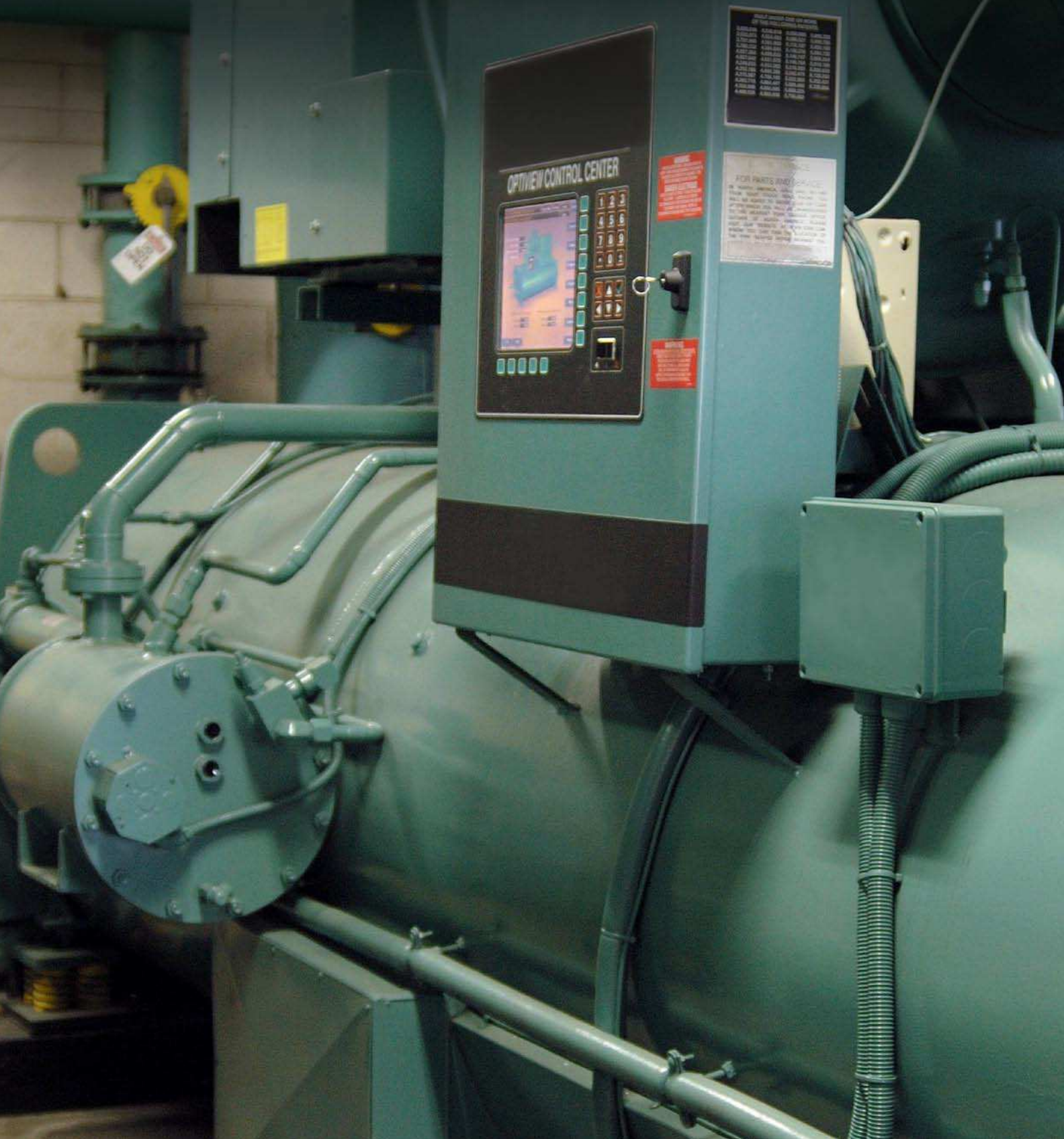

SKF is your source for seals, too

For decades, leading manufacturers have relied on SKF bearings – and SKF bearing expertise – to optimize screw compressor performance. SKF's deep knowledge of compressor application challenges and how to overcome them has raised the performance bar again and again. Now manufacturers are relying on SKF for something else, too.

As the only major bearing company with engineering and seal-making capabilities, SKF is able to support your design team with a unique combination of competencies. And with a wide range of off-the-shelf and customized PTFE seals.

Because we understand what causes bearings to fail, we understand what causes them not to fail. And that includes advanced sealing solutions that meet the precise demands of particular compressor applications.

When you think of SKF, think seals, too. Because taking a systems approach to bearing and seal design can help you improve your product and give you a competitive edge in the marketplace.

Gases, lubricants, and temperatures involved in a specific application can greatly impact the lifecycle and performance of bearings and seals. The selection of seal material and/or design therefore might mean the difference between poor, adequate, or exceptional product performance in the application and the marketplace. SKF can help you make the best choice.

Whether you want to improve an existing design or create a new one, SKF can help you analyse application demands and select the optimum sealing solutions to meet them.

SKF seals include off-the-shelf sizes, designs, and PTFE compounds, as well as fully customized sealing solutions. We can work with you to evaluate sealing variations on your test rig, or on our own virtual test rig which uses 3-D modelling software to simulate seal and bearing performance under a variety of conditions.

Whether your application involves compressed air, refrigeration and air conditioning, or natural gas, SKF can help you design and build compressors that:

- deliver higher energy-efficiency
- operate at higher speeds
- withstand higher temperatures
- accommodate higher pressure
- withstand aggressive media
- decrease maintenance demands
- have longer lifecycles



In-house PTFE seal manufacturing

To provide optimum quality and customizability, SKF operates its own dedicated PTFE seal manufacturing facility, which is ISO-certified to make sure required standards are met.

There, SKF engineers oversee a multi-step process that turns PTFE powder into finished seals. Materials are moulded into billets, CNC machined, then examined with state-of-the-art inspection equipment and software.

This in-house manufacturing capability enables SKF to produce more than 100 different types of PTFE-based materials, each with slightly different performance characteristics to meet any application demand.

Controlled quality procedures through the entire process – from PTFE powder to finished seals – allows SKF to provide world-class components for your world-class compressors.

A sealing solution for every application

Chemically inert with excellent speed, temperature, and pressure resistance, PTFE is the ultimate material for screw compressor seals. Customized or off-the-shelf, PTFE seals from SKF meet the performance requirements of most screw compressor applications, including compressed air, refrigeration and air conditioning, or natural gas. Below are some samples of the sealing solutions we offer for screw compressors.

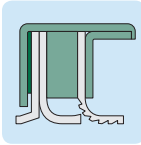

Air compressor shaft seals

During normal operation of an oil-injected screw compressor, the shaft seal prevents contaminant ingress, and at shutdown keeps pressurized air and oil where they belong. SKF radial shaft seals made of PTFE offer improved performance in air compressors. An optional front-lip spiral can be added for superior oil retention. When used in combination with an SKF wear sleeve, this complete sealing solution will help extend

service life and enable easier field repairs. General specifications can be found in **diagram 1**.

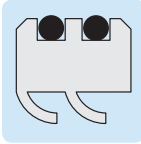

Internal screw seals

When used at the discharge end of air-conditioning compressors, PTFE seals can control hot gas bypass, thereby increasing volumetric efficiency, improving reliability and extending service life. Low friction rates and reduced lip loads optimize the balance between internal leakage and seal torque drag to provide optimum energy efficiency. Reduced bearing housing pressure leads to reduced axial load, keeping bearings operating at optimum performance levels. General specifications can be found in **diagram 1**.

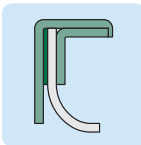

Mechanical seal oil retention

In refrigeration compressors, proprietary SKF oil retention seals keep the mechanical seal submerged in oil to reduce wear of the seal faces. By retaining a small supply of oil in this critical seal part – even during power-down periods – SKF oil retention seals help support and extend mechanical seal operation. General specifications can be found in **diagram 1**.

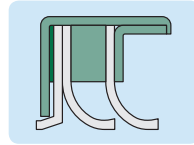

Mechanical seal replacements

For certain applications, PTFE seals provide a low-maintenance, low-wear, simple alternative to mechanical seals. The high-pressure resistance capabilities of PTFE seals help prevent external leakage. General specifications can be found in **diagram 1**.



Wear sleeves

Featuring a hardened, plunge-ground finish that offers the ultimate sealing surface, SKF wear sleeves are an excellent complement to PTFE radial shaft seals. Produced to the same high standards as the inner rings of SKF needle roller bearings or cylindrical roller bearings, SKF wear sleeves will outlast and outperform most standard steel shafts. Common sizes are listed in **table 1**.

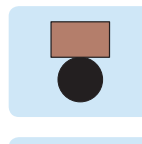

Piston seals, rod seals and guide rings

For slide-valve modulation systems, piston seals, rod seals and guide rings provide low seal wear, low cylinder wear, and low friction to keep your part-load operations at maximum efficiency and reliability. Our expertise in hydraulic and pneumatic sealing enables SKF to offer standard housing sizes or customized sizes and designs for your specific needs.

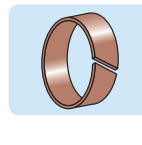
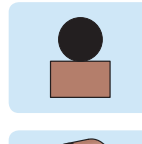

Intake and poppet valve seals

Intake air valves or poppet-type modulation systems often subject seals to both slow dynamic rotation and reciprocating movement, operating in pressure or vacuum. These seals incorporate a metal spring that loads the seal lips against the mating hardware. The spring can be cantilever or helical-wound type. The seal jacket is produced from a filled PTFE material or other advanced polymers such as PEEK, UHMWPE, acetal or nylon.

Standard sizes and specifications

SKF offers standard sizes and designs in accordance with DIN, ISO, or RMA standards, as well as the customized solutions that grueling compressor applications often demand. **Table 1** pairs several seal sizes with standard wear sleeves for the ultimate long-term performance. **Diagram 1** includes general specifications for radial lip shaft seals.

Table 1

Radial shaft seals – standard sizes (mm)

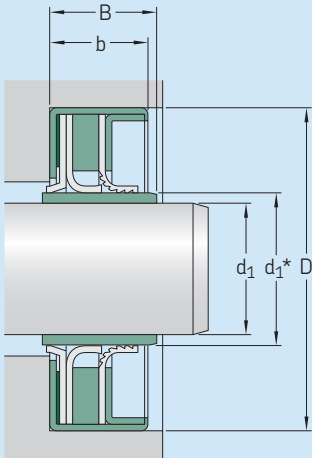

Wear sleeve

Shaft diameter d_1	Sleeve outside diameter d_1^*	Nominal width B
mm		
17	22	13
20	25	17
25	30	18
30	35	20
40	45	20
45	55	22
50	55	25
60	70	25
65	75	28
70	80	25
75	85	30
80	90	25
90	100	36

Seal

Sleeve outside diameter d_1^*	Bore diameter D	Nominal width b^{**}
mm		
22	35 / 40 / 47	
25	40 / 47 / 52	
30	42 / 47 / 52	
35	50 / 52 / 55	
45	62 / 65	
55	72 / 80	
55	72 / 80	
70	90 / 95	
75	95 / 100	
80	100 / 110	
85	110 / 120	
90	110 / 120	
100	120 / 125 / 130	

*Acting seal counterface diameter

**Any width, within certain limits depending on seal type

Radial shaft seals general specifications

The diagram on the right shows the typical acceptable pressure limits at given velocities. This is based on sealing a lubricating oil. Higher pressure and/or speeds are acceptable for short durations. Continuous higher pressures and velocities are possible depending on the other application conditions.

The filled PTFE compounds used in these seals have a temperature range from cryogenic to +230 °C (+445 °F). The temperature limitations for the seals are typically based upon the elastomeric gasket used as a static internal seal in the metal case, or the elastomeric O-ring used as a static gland seal for the all-PTFE lip seal. PTFE lip seals are generally used from temperatures of -40 to +200 °C (-40 to +390 °F).

Diagram 1

Pressure, velocity diagram

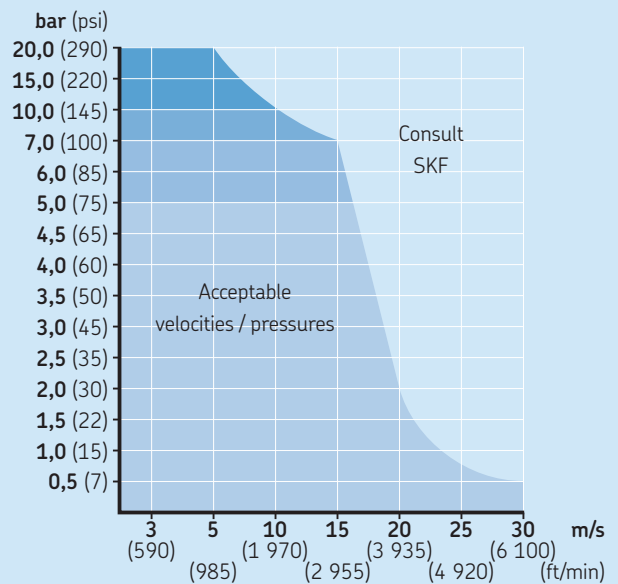

For more details, contact your local SKF representative.

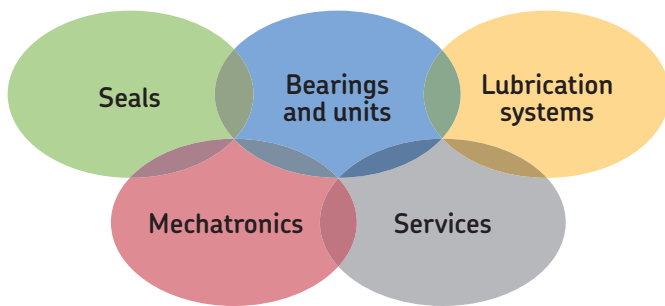

The Power of Knowledge Engineering

Drawing on five areas of competence and application-specific expertise amassed over more than 100 years, SKF brings innovative solutions to OEMs and production facilities in every major industry worldwide. These five competence areas include bearings and units, seals, lubrication systems, mechatronics (combining mechanics and electronics into intelligent systems), and a wide range of services, from 3-D computer modelling to advanced condition monitoring and reliability and asset management services. A global presence provides SKF customers uniform quality standards and worldwide product availability.

© SKF is a registered trademark of the SKF Group.

© SKF Group 2009

The contents of this publication are the copyright of the publisher and may not be reproduced (even extracts) unless written permission is granted. Every care has been taken to ensure the accuracy of the information contained in this publication but no liability can be accepted for any loss or damage whether direct, indirect or consequential arising out of the use of the information contained herein.

PUB 52/S1 10085 EN · September 2009

Printed in Sweden on environmentally friendly paper.

Certain image(s) used under license from Shutterstock.com.

