

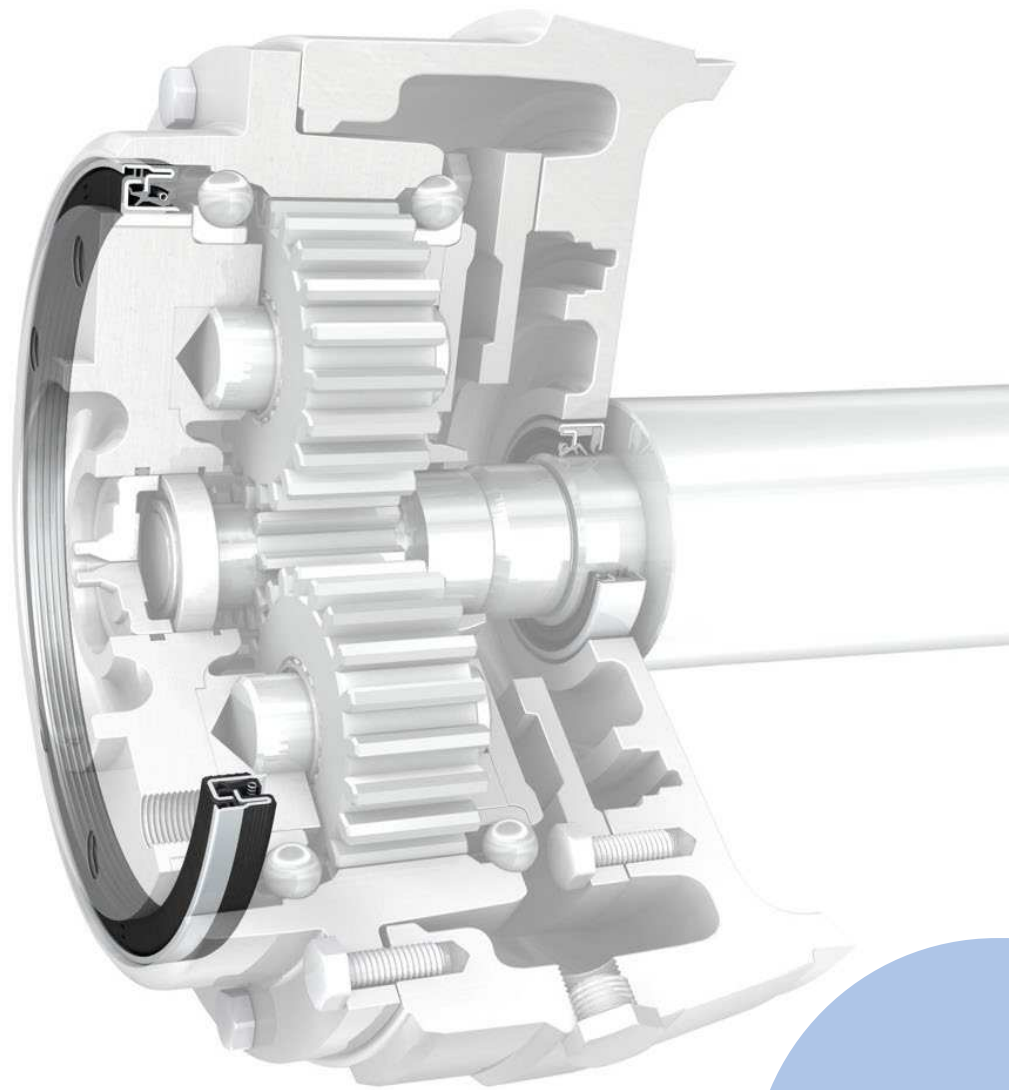

SKF Mudblock cassette seals

A new generation of radial shaft sealing units
for off-highway, oil-lubricated applications





SKF Mudblock seals provide excellent oil retention to minimize environmental impact.

Up to 50% longer service life and 20% less friction

To see how the new generation SKF Mudblock seals for oil-lubricated applications compare to conventional cassette seal designs, SKF conducted a punishing series of performance tests. The results speak for themselves: SKF Mudblock new generation seals lasted up to 50% longer and operated with up to 20% less friction than the competitor's seal. Yet SKF Mudblock seals also offered superior oil retention and contamination exclusion in the harshest, most contaminated conditions.

For end-users, the extended service life and superior performance means less unplanned downtime and maintenance, and more time for productive, profitable activities. For OEMs, the boost in service life and reliability means a competitive market advantage and fewer warranty issues.

Interchangeable and easy to handle and install

Fully interchangeable with alternative seal designs available in the market, the SKF Mudblock seals offer OEMs a range of extensively tested, pre-validated sealing retrofit options. The seals feature an integrated sleeve as the main lip counterface, which eliminates the need for costly shaft machining operations like grinding and hardening.

The seal and sleeve are also unitized with a curled design feature that helps prevent damage during transportation, handling and installation. Additionally, SKF Mudblock seals do not require specific assembly tools.

A better seal for better wheel-end protection

Wheel-end bearings in agricultural equipment are expected to endure long, intensive work periods during which they are exposed to water, mud, straw and other contaminants. Front and rear wheel axles in certain construction equipment face equally grueling conditions.

Whether they occur on the farm or the construction site, harsh operating conditions can lead to seal failures that allow contaminant ingress, lubricant loss, and eventually, premature bearing failures.

For farmers and contractors, wheel-end bearing failures can limit productivity and drive maintenance costs. For OEMs, they can increase warranty claims while damaging customer relationships and brand reputations. The new generation SKF Mudblock seals for oil-lubricated applications can address these challenges and more.

Featuring a unitized, multi-lip seal design and high-performance elastomeric materials, these SKF Mudblock seals are the latest generation radial shaft sealing units. The seals deliver market-leading performance in terms of oil retention and offer robust protection from solid and liquid contaminants while reducing friction and extending seal service life.

Benefits

For OEMs

- Increased seal service life – up to 50%*
- Reduced seal friction – up to 20%¹⁾
- Extended wheel-end service life
- Reduced warranty claims and costs
- No need for expensive shaft machining
- Reduced inventory and import duties through localized sourcing

For end-users

- Increased productivity
- Reduced maintenance
- Lower operating costs

Applications

Front and rear wheel-ends of:

- Tractors
- Agricultural machines
- Construction machines

1) All figures are rounded off and compared to other top-quality cassette seal designs in the market. Savings and results will vary in specific applications.

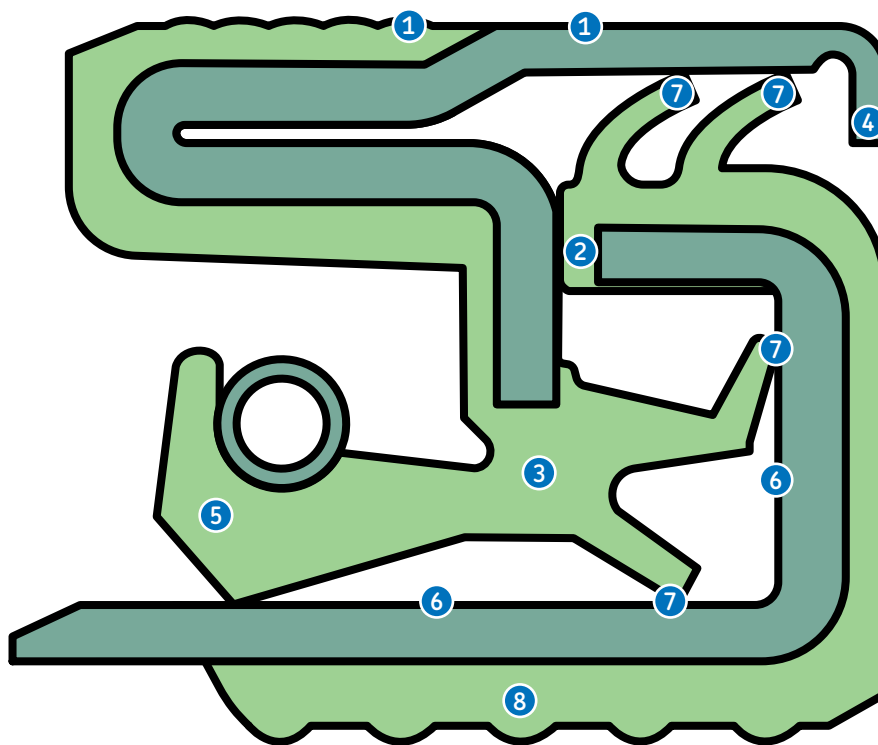

Designed for market-leading performance, MUD11

1 Half-metal/half-rubber outside diameter

Improves static sealing, heat dissipation and retention in housing.

2 Bumper

The bumper positions the sleeve relative to the seal to balance the right interference for the axial lips. It also acts as a line of defence against contaminants.

3 SKF developed nitrile rubber

Represented by all of the light-green areas in the illustration, this standard SKF Mudblock sealing lip material is a unique nitrile rubber compound. Specially formulated by SKF to help reduce wear and ageing, this advanced material is compatible with most synthetic oils.

4 Curl

Curled feature closes the unitized design, promotes easier installs and dismounts, and also prevents seal disassembly during transport and handling.

5 Main lip

The spring-loaded main sealing lip keep the sealing lips lubricated and promote sealing ability regardless of rotation direction. This results in less friction and wear for extended service life.

6 Integrated counterface

Wear sleeve and seal form a single, unitized seal unit that eliminates shaft machining requirements.

7 Multiple sealing lips

Pre-greased auxiliary radial and axial lips support the main lip for maximum protection against liquid or solid contaminant ingress.

8 Full rubber inside diameter

Contributes to effective static sealing and helps reduce the assembly force required for installation.



Advanced seal engineering and materials

Specially developed for heavy-duty jobs in harsh environments, new generation SKF Mudblock seals for oil-lubricated applications are a multi-lip, cassette sealing solution. Integrated seal and sleeve elements form a very robust, unitized design with FEA-optimized geometry and a unique, SKF-developed nitrile rubber. The combination offers excellent oil retention and protection from solid and liquid contaminant ingress.

Installation

Seal is installed in the housing bore

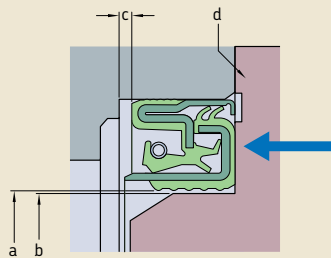

- a) Seal inside diameter
- b) Installation tool inside diameter
- c) Bore depth clearance
- d) Installation tool arrest

Shaft is introduced

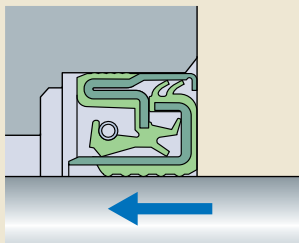

Recommended surface roughness values:
 Shaft: h8; Ra = 1,6 to 3,2 µm
 Housing bore: H8; Ra = 1,6 to 3,2 µm

Drop-in design flexibility

SKF Mudblock seals are interchangeable with alternative seal designs available in the market, enabling smooth retrofits. SKF Mudblock seals are available in a 25 – 250 mm shaft size range and feature an SKF developed nitrile rubber as standard. To meet diverse temperature and rotational speed requirements, the seals are also available in other elastomeric materials.

Product development support

SKF Knowledge Engineering supports OEM product development projects with a range of application, design and testing capabilities. Customized seal sizes, materials and solutions are available worldwide, including integrated SKF bearing and seal units. Dedicated SKF testing locations in Asia, Europe and the USA are also available for customer-specified trials.

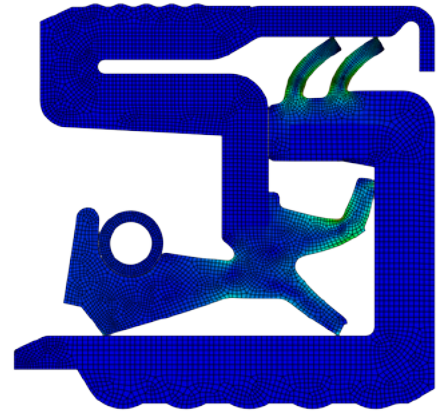

Local sourcing, global competence

Backed by the full SKF global footprint, SKF Mudblock seals for oil-lubricated applications are manufactured in several SKF locations worldwide, including Asia, Europe and the USA. More localized sourcing can help OEMs reduce or eliminate seal import duties as well as seal inventories.



SKF Mudblock seal for oil lubricated applications - new generation

Robust, lab-tested reliability

Mud slurry test results to seal failure

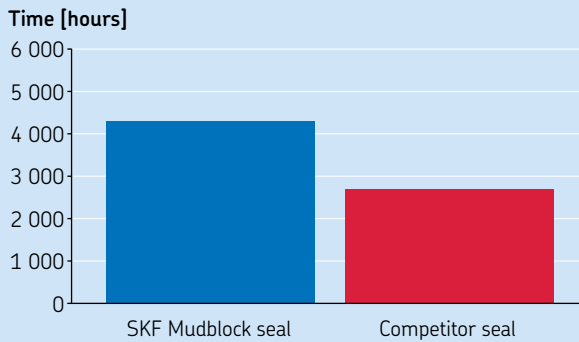

Mud slurry tests

SKF mud slurry tests simulate many thousands of hours of exposure to the most punishing liquid and solid contaminants. As this graph indicates, SKF Mudblock seals can outlast the competitor's seals by up to 1 700 hours.

Hot oil durability test results to seal failure

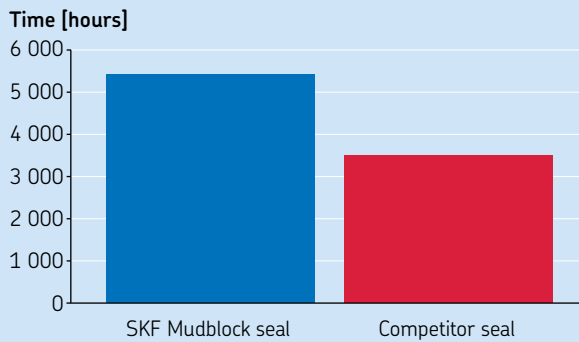

Hot oil durability tests

Deteriorating oil condition indicates the effectiveness of a seal's main oil retention lip. Featuring the seal profile, SKF Mudblock seals help extend oil durability, thereby reducing wear and contributing to significantly longer service life vs. the competitor's seals.

Friction test results

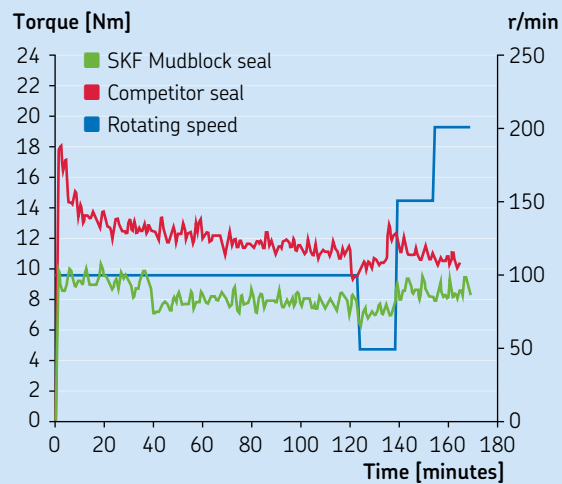

Friction torque tests

Seal friction depends on several factors, including design geometry, rubber material composition and speed. Thanks to their optimized geometry and high-performance nitrile rubber material, SKF Mudblock seals operate with up to 20% less friction than the competitor's seals.

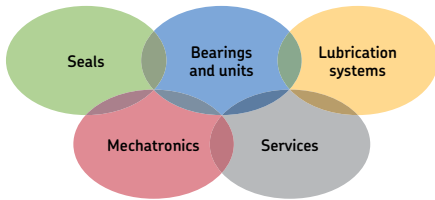

The Power of Knowledge Engineering

Combining products, people, and application-specific knowledge, SKF delivers innovative solutions to equipment manufacturers and production facilities in every major industry worldwide. Having expertise in multiple competence areas supports SKF Life Cycle Management, a proven approach to improving equipment reliability, optimizing operational and energy efficiency and reducing total cost of ownership.

These competence areas include bearings and units, seals, lubrication systems, mechatronics, and a wide range of services, from 3-D computer modelling to cloud-based condition monitoring and asset management services.

SKF's global footprint provides SKF customers with uniform quality standards and worldwide product availability. Our local presence provides direct access to the experience, knowledge and ingenuity of SKF people.

© SKF is a registered trademark of the SKF Group.

© SKF Group 2014

The contents of this publication are the copyright of the publisher and may not be reproduced (even extracts) unless prior written permission is granted. Every care has been taken to ensure the accuracy of the information contained in this publication but no liability can be accepted for any loss or damage whether direct, indirect or consequential arising out of the use of the information contained herein.

PUB 45/P2 14184 • September 2014

Certain image(s) used under license from Shutterstock.com

