



# Safety and reliability in motion

SKF capabilities for health care equipment



The Power of Knowledge Engineering

Need an equipment motion specialist?



# SKF brings a lot to the table.

Aging, obesity, and the increased population, along with rising costs and decreasing expenditures, coupled with disease prevention. All of these are growing challenges for today's health care industry.

To meet these challenges, today's medical equipment needs to enable faster, safer, more reliable diagnostics and treatments. Also keeping in mind that the equipment must be easy to use and ergonomically comfortable for both patient and caregiver.

To bring such equipment to market, medical OEMs need suppliers that can deliver the highest levels of component quality, as well as a combination of linear and rotary motion expertise. Familiarity and conformance with industry regulations and standards is also key.

It's a unique list of qualifications – one that SKF has been developing for more than three decades.

As a global leader in telescopic pillars and bearings, SKF offers a range of actuation and guiding systems, as well as bearings and seals. From design verification to delivery, SKF works together with OEMs to provide a range of next-generation health care equipment.

For example, SKF provides testing support during design, preproduction and production, and can help OEMs meet all requirements for industry norms and standards, including:

- **Optimum safety and reliability**
- **Conformance with standards like UL and EN**
- **Outstanding performance products**

## **Meet your challenges with SKF**

Working with SKF, equipment manufacturers can leverage our linear and rotary motion expertise to meet a complete range of design goals to benefit both medical specialists and patients.



- ✓ **Operational flexibility**
- ✓ **Smoother operation**
- ✓ **Improved ergonomics**
- ✓ **Contamination resistance**
- ✓ **Higher positioning accuracy**
- ✓ **Greater motion range for improved patient access**
- ✓ **Programmable functions**

# Using SKF knowledge to create the next

Developing equipment that meets the requirements of health care providers and patients requires a level of industry knowledge that most component manufacturers cannot provide. Then there's SKF.

Backed by deep industry expertise and close working relationships with top medical equipment manufacturers, SKF offers a unique understanding of today's application requirements. Combined with our linear and rotary motion expertise, it's allowing us to develop safer, more reliable and more ergonomic equipment.

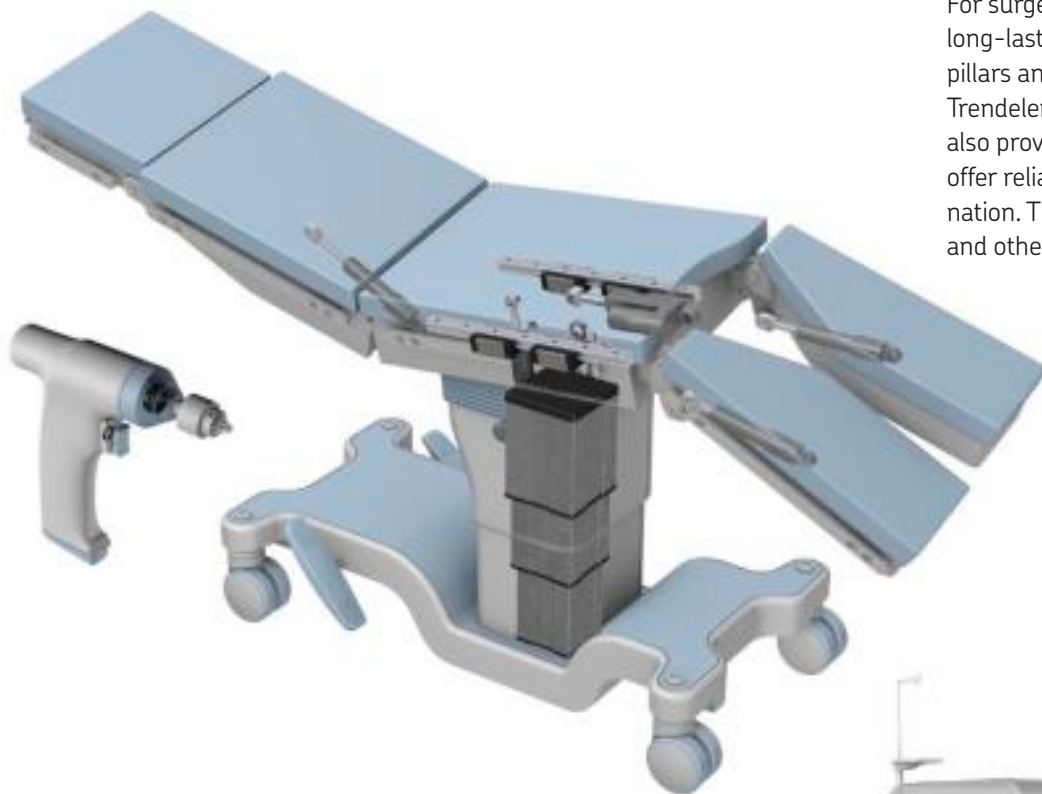

## Surgical table and tools

### Challenges

Increased motion functionality, clean surfaces, no contaminants

### SKF solutions

For surgery tables, SKF offers reliable and long-lasting solutions including a wide range of pillars and actuators for height adjustment, Trendelenburg and backrest movements. SKF also provides customized sealing solutions that offer reliable performance to prevent contamination. The applications include surgical tools and other medical devices.

## Incubators

### Challenges

Silent motion, soft starts/stops, optimized design

### SKF solutions

SKF offers low noise and virtually vibration-free pillars that support the ergonomics of the operators while delivering reliable functionality.



# generation of medical equipment

## Tomography equipment (CT, PET, SPECT)

### Challenges

Escalating patient weight and increasing regulations require improvements in equipment flexibility and productivity for improved patient throughput time, comfort and safety.

### SKF solutions

SKF actuators and pillars enable accurate, low-noise lifting. Low-friction profile rail guides provide greater load carrying capacity and precise, smoother movement. SKF also offers a wide range of ball and slewing bearings for more effective rotating function.



## Mobile C-arm

### Challenges

Ability to accommodate bigger patients, greater flexibility and more automated functionality

### SKF solutions

Low-noise, high-torque solutions for mobile C-arms include SKF pillars with integrated guiding and lifting functions, and profile rail guides designed to handle large offset loads.



# Improved productivity for care providers,

## Laboratory automation

### Challenges

Productivity in faster and flexible testing, less maintenance and longer service life, soft motion

### SKF solutions

SKF guiding, driving and rotational components for high-speed and high-precision positioning operate with low noise and are virtually maintenance-free.

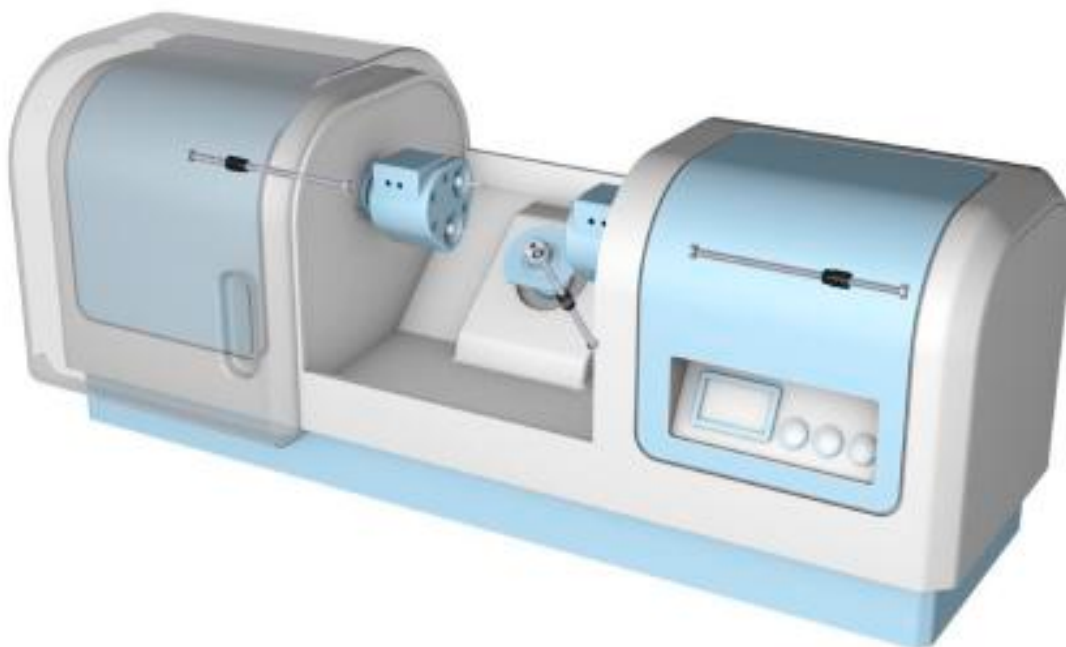
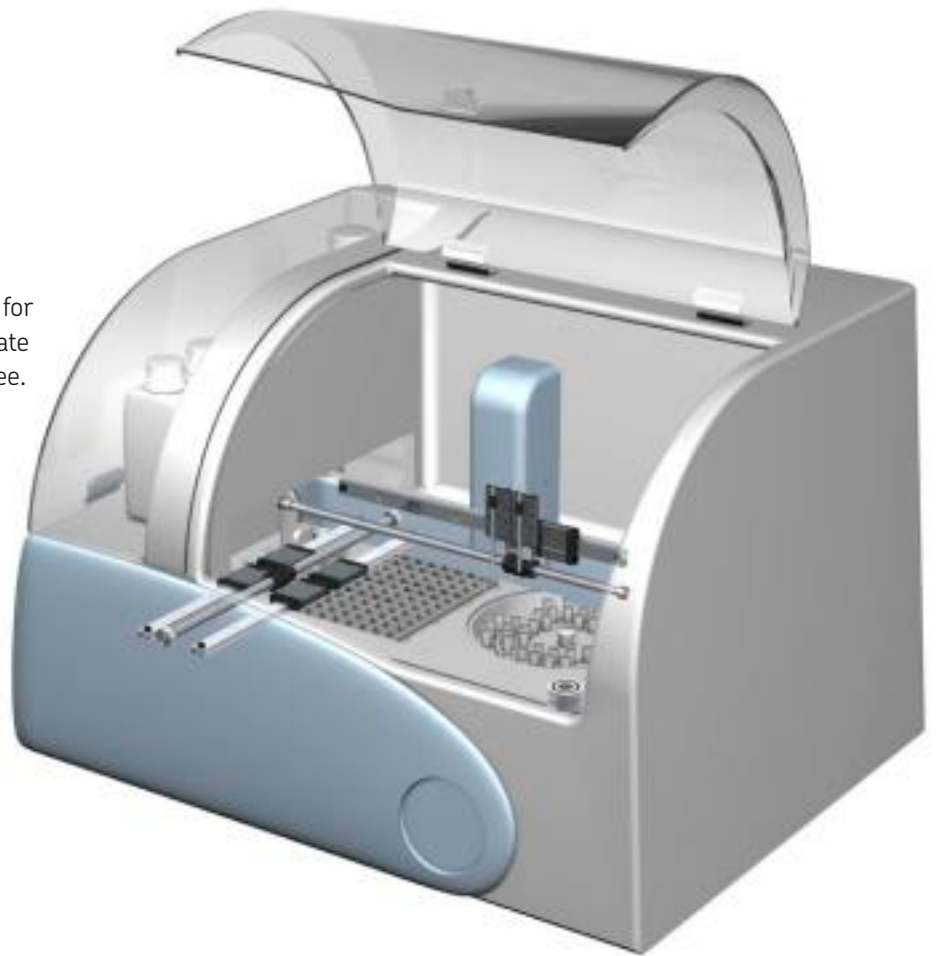

## Dental equipment

### Challenges

Integrated motion functionality, faster and precise movement

### SKF solutions

Enabling fast, quiet and precise motion, SKF screws, bearings and guiding systems improve equipment reliability and productivity.

# improved safety and comfort for patients

## Ophthalmic equipment

### Challenges

More precise and ergonomic motion combined with programmable and easy-to-use functions

### SKF solutions

Compact, modern pillar designs offer quiet operation of chairs, tables and devices. The SKF range includes special add-ons, such as AC inlets and outlets, integrated control units and handsets. For the measurement equipment, a full range of guiding solutions is available.

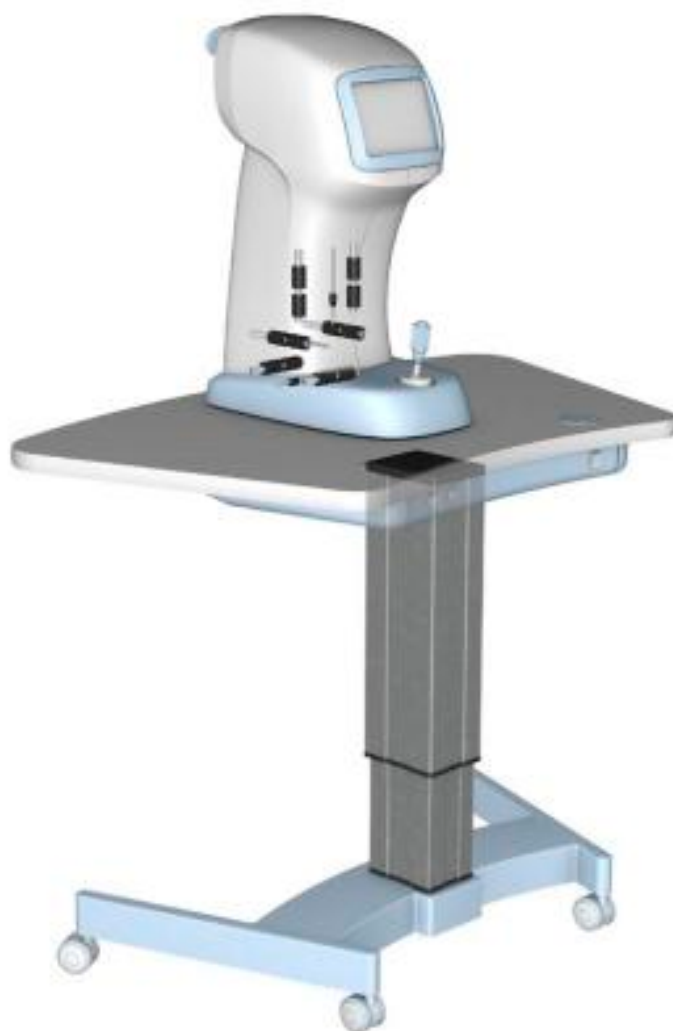

## Hospital equipment

### Challenges

Robust lift motion, easy to clean, complete drive solution package

### SKF solutions

The extensive range of actuation systems from SKF includes a compact design with maximum speed and load capabilities. Smooth, silent function helps to improve patient comfort and ease of use.

# Advancing care with solutions for lifting,

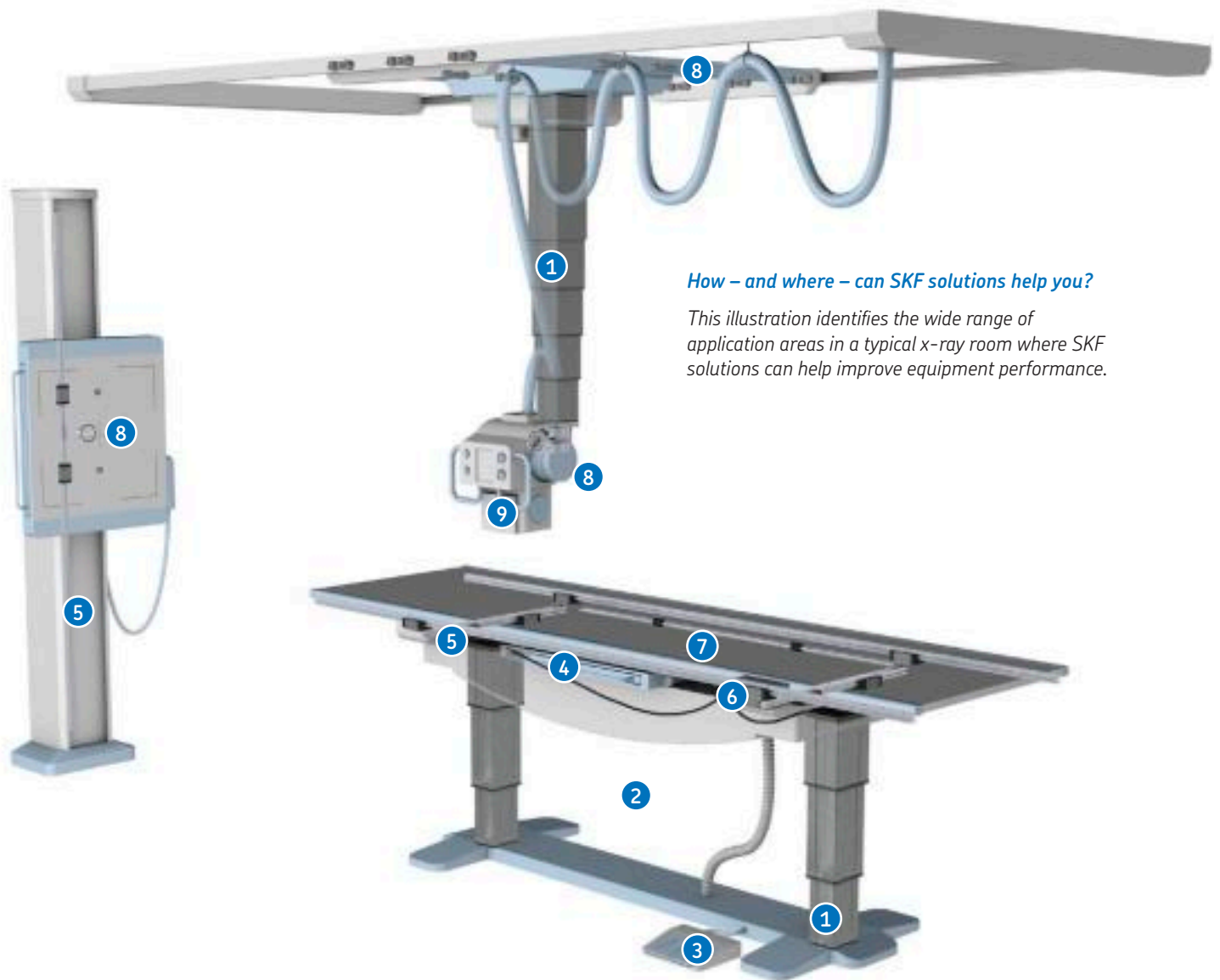

## How – and where – can SKF solutions help you?

This illustration identifies the wide range of application areas in a typical x-ray room where SKF solutions can help improve equipment performance.

## Lifting

### 1 Telescopic pillars

SKF offers telescopic pillars with very low retracted length and EN/UL certification. Able to handle heavy offset loads, robust SKF telescopic pillars give OE designers greater flexibility in terms of lift function placement. Providing long stroke length and fast, silent operation, SKF pillars incorporate guidance functions within the actuation system.



### 2 Linear actuators

SKF actuators combine compact design with maximum speed and load capabilities. Smooth, silent operation helps improve patient comfort and ease of operation, while very low retraction and unlimited installation angles allow for greater design flexibility (e.g. scissor lift table).



### 3 Handsets and controls

Designed to work with a wide range of pillars and actuators, SKF control boxes and handsets put design flexibility and simplicity within reach. Featuring high reliability and long service life, SKF boxes and handsets enable precision synchronization and control of multiple actors. Complete component compatibility also helps reduce design and sourcing time.





# guiding, turning, sealing and more



## Guiding

### 4 Linear ball bearings

Combining adjustable precision, low friction and long service life, SKF linear ball bearings offer designers a flexible, easy-to-integrate solution that is virtually maintenance-free. The miniature linear ball bearing range features robust stainless steel raceways, making them ideal for downsizing linear shafting movements.



### 5 Profile rails

SKF Profile rail guides provide precise, effortless linear positioning of the patient. Designed to handle high operational speeds and heavy loads, these low-noise, low-friction units are easy to mount. SKF Profile rail guides are virtually maintenance-free and are available in a wide variety of sizes and types, including a miniature range in stainless steel.



### 6 Precision rails

Along with the ultra-precise movement that their name implies, SKF precision rail guides deliver nearly frictionless movement in linear positioning. Non-recirculating ball and roller guides offer extremely smooth operation and low noise for optimum patient comfort, while the low-friction running guide helps to ensure precise manual positioning.



## Driving

### 7 Ball screws

Featuring high reliability and repeatability, precision SKF ball screws increase instrument performance and accuracy. Customized lubrication options enable maintenance-free ball screws for specific applications. SKF miniature ball screws deliver smooth, quiet operation for a range of dental and laboratory applications.



## Turning

### 8 Ball and slewing bearings

Our extensive selection of bearing types can meet virtually any application demand, from quiet, smooth-running operation to long-term reliability. Customized, low-noise slewing bearings increase design flexibility and patient comfort.



### 9 Seals

SKF offers advanced sealing solutions for all bearing types, as well as a range of laboratory, surgical and other specialized medical applications. Working with OEM design teams to meet specific demands, SKF has developed custom PTFE and other specially formulated sealing materials.

# Improve your design with SKF knowledge and engineering support

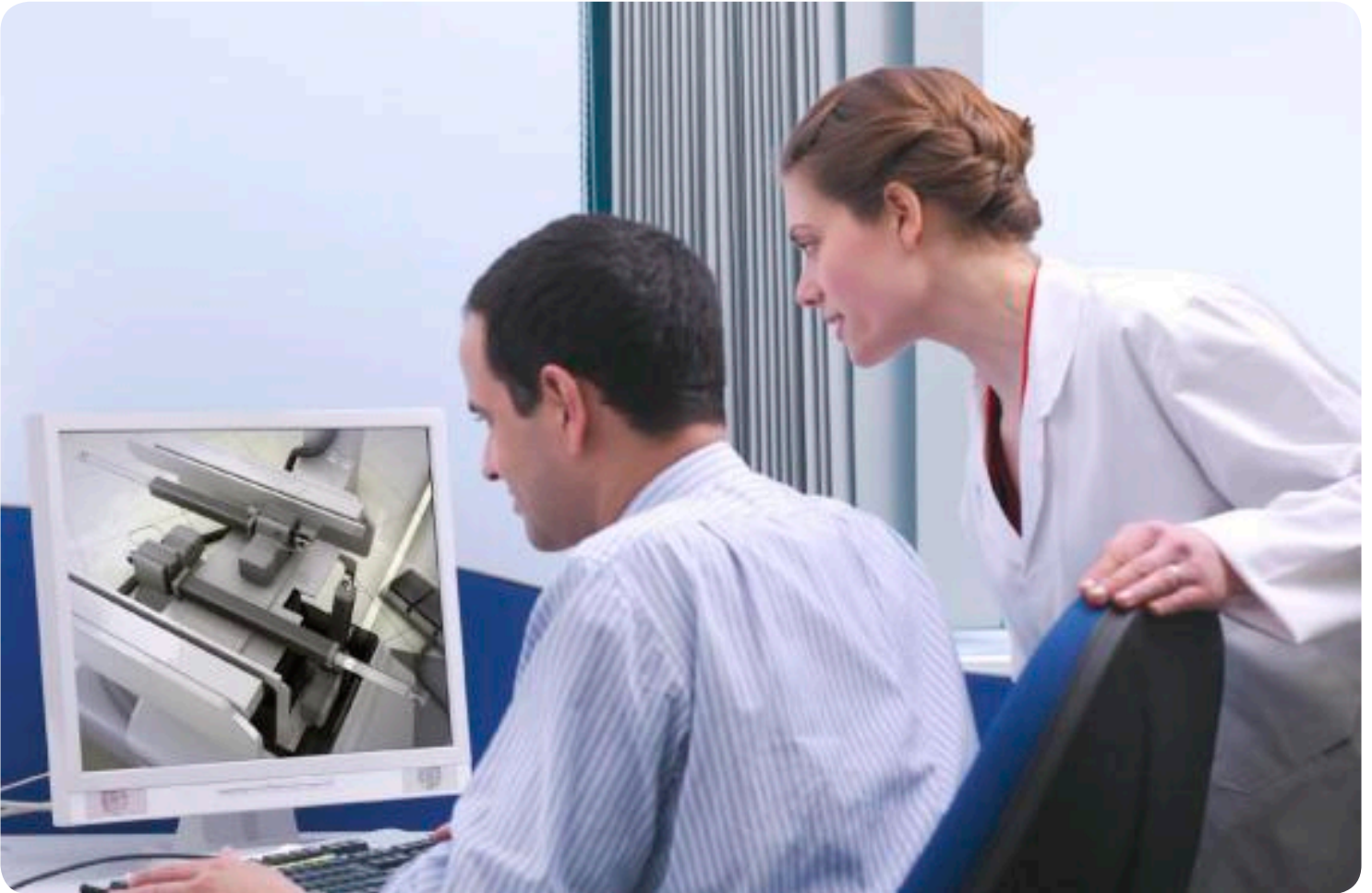

SKF can help you develop customized solutions from our standard components and sub-systems. Drawing on our deep knowledge in linear and rotary motion, SKF engineering consultants can work closely with your design team to develop safe, reliable designs inline with UL/EN 60601 standards.

## **SKF Engineering Consultancy Services**

SKF consultants can help you take designs from concept to reality. Using advanced, proprietary simulation software, SKF can optimize designs while still in the prototype stage, reducing development time and helping to make sure that your new design will be right from the start. Or we can help you troubleshoot an existing design to better understand the cause of failure or underperformance.

You can explore the merits of various options prior to prototyping, or subject prototypes to actual application conditions with a virtual SKF test rig. In short, SKF Engineering Consultancy Services can help you outperform the competition in several ways. Benefits include:

- **Reduced total costs**
- **Reduced time to market**
- **Improved manufacturing and assembly**
- **Faster delivery times**
- **Improved product reliability**
- **Reduced product maintenance**
- **Lighter, more compact designs**

*See inserts for more details  
about SKF solutions for the  
medical and health care industry*



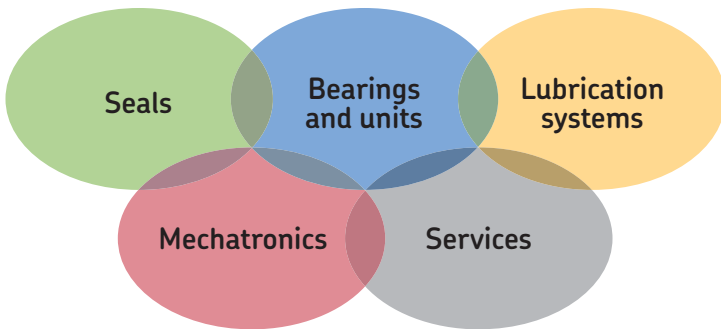

### The Power of Knowledge Engineering

Drawing on five areas of competence and application-specific expertise amassed over more than 100 years, SKF brings innovative solutions to OEMs and production facilities in every major industry worldwide. These five competence areas include bearings and units, seals, lubrication systems, mechatronics (combining mechanics and electronics into intelligent systems), and a wide range of services, from 3-D computer modelling to advanced condition monitoring and reliability and asset management services. A global presence provides SKF customers uniform quality standards and worldwide product availability.

© SKF is a registered trademark of the SKF Group.

© SKF Group 2012

The contents of this publication are the copyright of the publisher and may not be reproduced (even extracts) unless prior written permission is granted. Every care has been taken to ensure the accuracy of the information contained in this publication but no liability can be accepted for any loss or damage whether direct, indirect or consequential arising out of the use of the information contained herein.

PUB 66/S2 12648 EN · August 2012

Certain image(s) used under license from Shutterstock.com