

Block metering device VPB

Block feeder for use in oil or grease lubrication systems

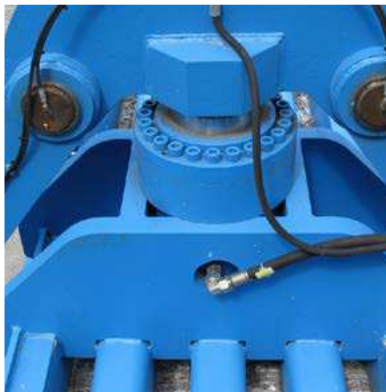

Block metering device VPB

Block metering devices or feeders of the VPBM/VPBG series are used in small circulating-oil lubrication systems as well as in grease and oil total loss lubrication systems. Fields of application are, for example, metal-forming machines, vehicles, production systems in the automotive industry as well as packaging and printing machines.

Advantages:

- Robust and cost-efficient
- Usable for the widest possible range of applications with regards to mode of operation (continuous/intermittent) and lubricants
- Central function monitoring of all feeder ports with a minimum of effort
- Number of cycles: max. 200/min
- Available in metric design as VPBM or in inch design as VPBG
- Defined volume portion per cycle and outlet of 0,20 cm³
- Accurate lubricant distribution, even with back pressure at the lubrication points, due to fitted pistons
- The feeders are available with 6 up to 20 outlets
- Maximum number of lubrication points (per system) approximately 100; for ring-line systems with in-line pumps several hundred
- Pressure range: 30 to 200 bar for circulating-oil lubrication systems; 300 bar for grease systems
- Basic design zinc coated, optionally of stainless steel, or in waterproof design

Table of contents

| | | | |
|--|---|---|----|
| Advantages | 2 | Block metering device VPB, basic design | 5 |
| Table of contents | 2 | Block metering device VPB with piston detector | 6 |
| General information | 3 | Block metering device VPB with cycle indicator | 6 |
| Operation of block metering device VPB | 3 | Block metering device VPB with 2/2 directional solenoid valve | 7 |
| Information on the VPB design | 4 | Order code | 8 |
| Combination of outlets | 4 | Example of possible variations | 9 |
| Operating pressure and temperature | 4 | Crossporting versions | 9 |
| Number of cycles | 4 | Check valves | 10 |
| Quantity distribution | 4 | Accessories | 10 |
| Monitoring | 4 | Spare parts | 11 |
| Attachments | 4 | | |

Block metering device VPB

General information

The block metering device VPB, which belongs to the progressive feeder range, is available in the designs VPBM (metric threaded connectors) and VPBG (inch threaded connectors). The block feeders VPBM and VPBG are pre-set to a fixed dosing volume of 0.2 cm³ per outlet and cycle.

The volumetric flow, which is sent via a tube, is forcibly distributed in a predetermined ratio to the outlets, i.e. to the lubrication points or the downstream progressive feeders. Pistons, which are aligned in series, meter the lubricant for two opposite outlets each and control the function of the neighboring piston. This way, the function of the sectional feeder can be checked by monitoring any piston with a cycle indicator or a piston detector. The optional add-on check valves offer high functional reliability (for high or different back pressures). They also provide an accurate feed and safe blocking behavior, even for internal or external combinations.

Operation of block metering device VPB

The task of the progressive metering device is to distribute consecutively specified portions of the pressure-fed lubricant (grease or oil) to the connected lubrication points. The discharge of the lubricant continues as long as it is pressure-fed to the progressive feeder. The specified portions are metered through the piston movement. Two lubricant outlets on the two end positions of the piston travel are allocated to each piston. The number of pistons within a feeder is variable. If lubricant is pressure-fed, the pistons of a feeder move in turn to their end position. The piston movement displaces a portion of the lubricant that is upstream of the piston to the downstream outlet. The movement of a piston can only start after the upstream piston has been moved to its end position.

If all pistons are in their left or right end position, internal connecting bores in the feeder ensure a defined and continued running of the pistons. When all pistons have been moved once to the left as well as to the right end position, all connected lubricant points have been supplied once with the preset lubricant quantity. The portions

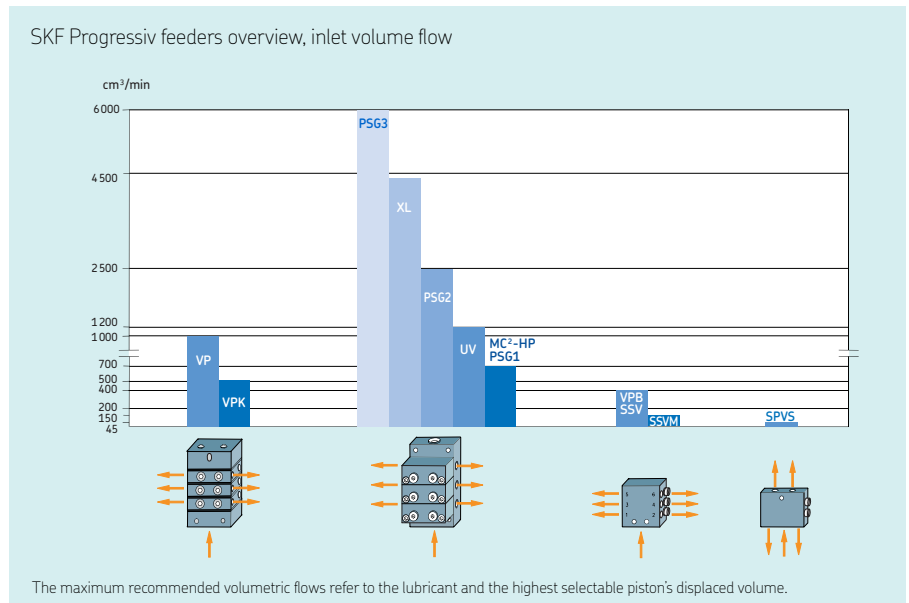

for both outlets are determined by the diameter and the travel of the piston. The selection of the required portion is made during the design of the feeder. A subsequent change of the portions is only possible through a modification of the feeder.

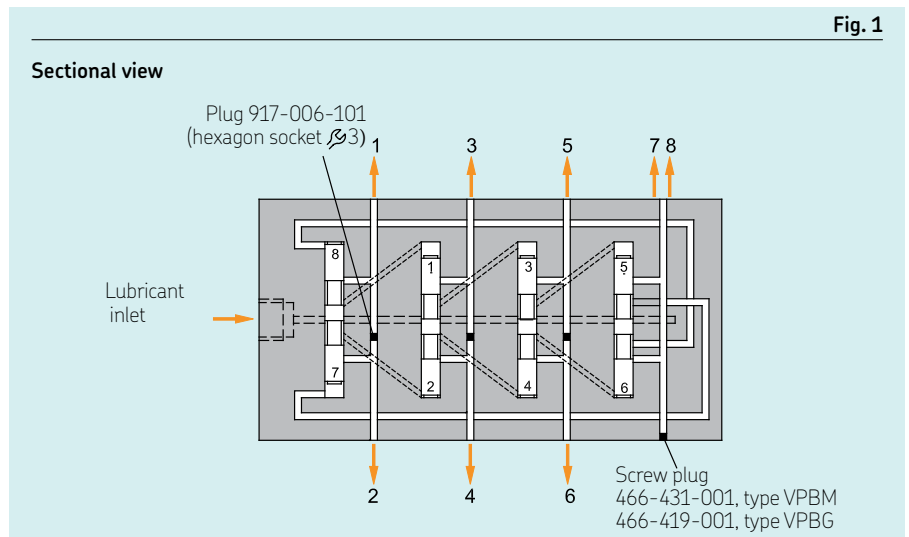

Block metering device VPB

Information on the VPB design

The general criteria for the design of progressive feeders also apply without restrictions to the sectional metering device VPB. In case of an installation on movable machine parts or in case of strong vibrations (e.g. on grease guns), the piston position of the feeder should not correspond with the direction of movement of the machine part.

Combination of outlets → Fig. 2

Possibility of a subsequent internal connection of two opposing outlets by removing the screw in plug from the right outlet bore and blocking one of the two outlets.

Operating pressure and temperature

The maximum permissible operating pressure of the block distributor is 300 bar. If oil is delivered, a maximal operating pressure of 200 bar is recommended.

The operating temperature range given in technical data for the respective characteristic has to be met.

Number of cycles

A maximum of 200 cycles/min is recommended.

Quantity distribution

Block feeders distribute an amount delivered by a pump to several outlets while the feeder determines the volumetric ratio.

The different output quantities within a feeder are achieved by connecting two or more outlets. The indicated lubricant quantities result from the piston diameter and the maximum travel of the piston. Depending on the system design, these capacities may vary by 35%. By grease plants, with master feeder/secondary feeder systems, check valves must be used on the feeder outlets of the master feeder.

A connection of opposing outlets is possible by removing the plug. Furthermore, connecting neighboring outlets is possible by optionally applied crossports (crossporting). → Fig. 3

Monitoring → Fig. 4

The block feeder can be monitored directly by means of a piston detector (compare in the order code: parameters piston detector, monitoring type P2, P3) and can be retrofitted. Furthermore, the piston movement can be monitored by visual stroke monitoring, monitoring type ZY.

Both monitoring models can be used both for oil as well as for grease.

Attachments → Fig. 5

The block feeder VPB can be equipped with upstream 2/2 directional solenoid valve, attachment 15.

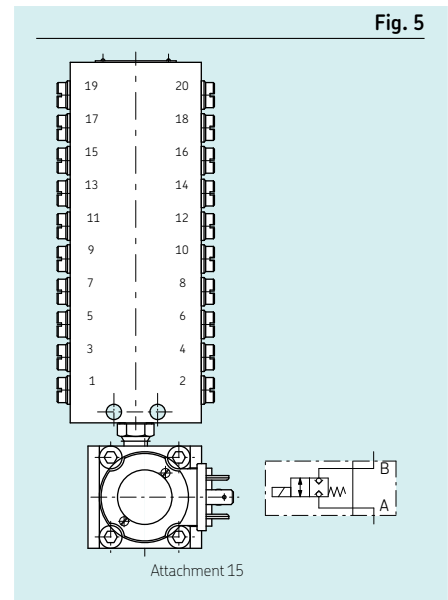
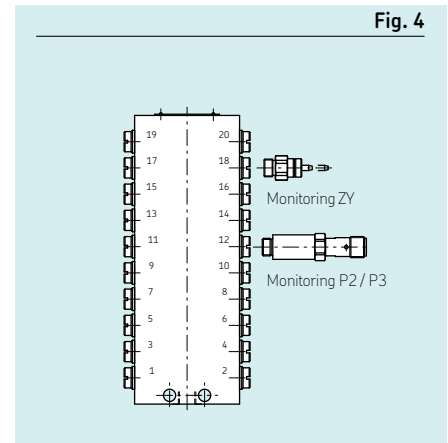
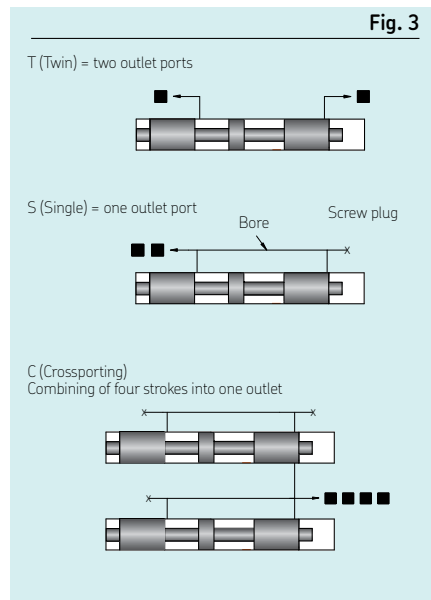
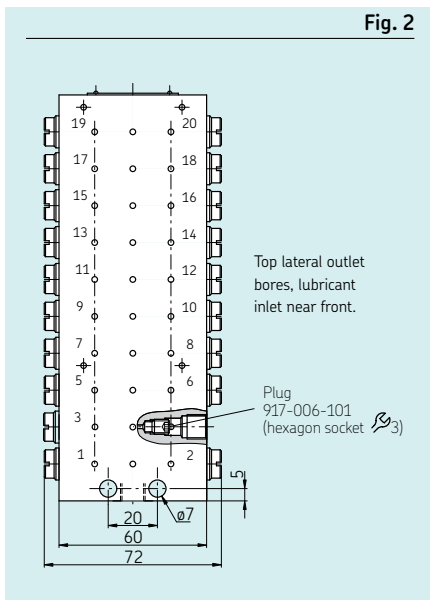

Block metering device VPB, basic design

for oil or grease, without attachments, without monitoring

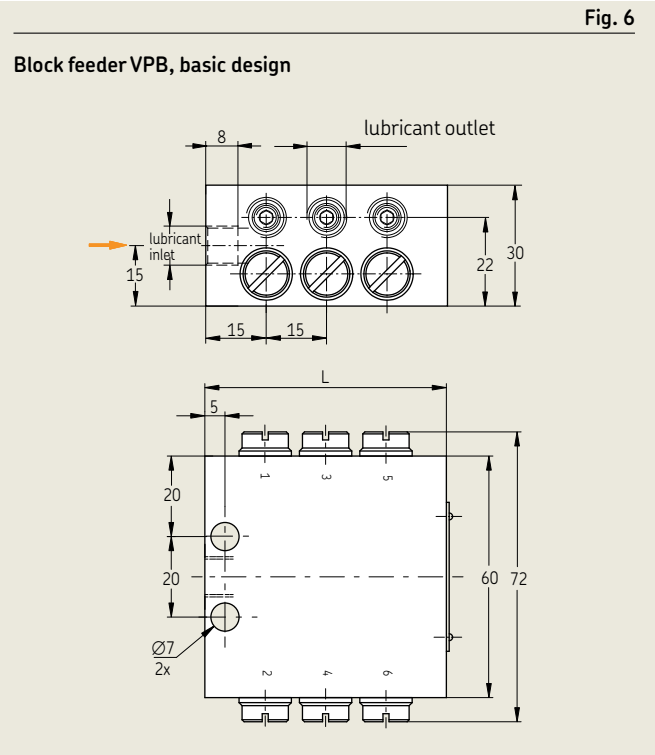

Technical Data

| | |
|------------------------------|--|
| Style | hydraulically controlled |
| Mounting position | any |
| Screw connection | |
| Inlet / outlet | VPBM = M10x1 / VPBG = G1/8 |
| Ambient temperature range | -25 to +110 °C |
| Feeder sections | → Table 1 |
| Quantity of outlets | 6 to 20 |
| Material | Steel, tinned/ nitrile |
| Operating pressure max. | Oil 200 bar, grease 300 bar |
| Volumen per outlet and cycle | 0.20 cm ³ |
| Lubricant | Mineral oils, grease based on mineral oil, environmentally friendly and synthetic oils and greases |
| Operating viscosity | > 12 mm ² /s |
| Worked penetration | ≥ 265 x 0.1 mm (up to NLGI-grade 2) |

Table 1

Dimensions

| Type of threading | | Number of feeder sections | Number of possible outlets | L [mm] |
|-------------------|----------|---------------------------|----------------------------|--------|
| M10x1 | G1/8 | Type | Type | |
| VPBM-3 * | VPBG-3 * | 3 | 6 | 60 |
| VPBM-4 | VPBG-4 | 4 | 8 | 75 |
| VPBM-5 | VPBG-5 | 5 | 10 | 90 |
| VPBM-6 | VPBG-6 | 6 | 12 | 105 |
| VPBM-7 | VPBG-7 | 7 | 14 | 120 |
| VPBM-8 | VPBG-8 | 8 | 16 | 135 |
| VPBM-9 | VPBG-9 | 9 | 18 | 150 |
| VPBM-10 | VPBG-10 | 10 | 20 | 165 |

* This progressive feeder must be installed with check valves.

Table 2

Inlet screw connection

| Designation | Order code |
|--|----------------|
| M10 x 1 for tube Ø6 mm | 406-423 |
| M10 x 1 for tube Ø8 mm | 441-008-511 |
| M10 x 1 for tube Ø10 mm | 410-443 |
| M10 x 1 Plug-in connector for tube Ø6 mm | 451-006-518-VS |
| G1/8 for tube Ø6 mm | 406-403W |
| G1/8 for tube Ø8 mm | 408-423W |
| G1/8 for tube Ø10 mm | 410-443W |
| Plug-in connector for tube Ø6 mm | 406-423-VS |

Table 3

Outlet screw connection

| Designation | Order code |
|---|----------------|
| M10 x 1 for tube Ø4 mm | 404-403 |
| M10 x 1 for tube Ø6 mm | 406-423 |
| M10 x 1 tap. Plug-in connector for tube Ø4 mm | 451-004-518-VS |
| M10 x 1 tap. Plug-in connector for tube Ø6 mm | 451-006-518-VS |
| G1/8 for tube Ø4 mm | 404-403W |
| G1/8 for tube Ø6 mm | 406-423W |
| G1/8 Plug-in connector for tube Ø4 mm | 404-040-VS |
| G1/8 Plug-in connector for tube Ø6 mm | 406-423W-VS |
| Screw plug M10 x 1 | 466-431-001 |
| Screw plug G1/8 | 466-419-001 |

Block metering device VPB

monitored by piston detector, for oil and grease



Technical Data

For further technical data → basic design, page 5

Piston detector, electrical *

| | |
|---------------------------|----------------|
| Internal thread | M10×1 |
| Ambient temperature range | -25 to + 80 °C |
| Load current max. | 100 mA |
| Protection class | IP67 |

Piston detector 2-pin (P2)
(short-circuit protection, intermittent and protected against polarity reversal)

| | |
|----------------------|------------------------------------|
| Design | with 4-point-LED, 2 pin connection |
| Rated voltage | 10 to 36 V DC |
| Residual ripple | 3% to 15% |
| Output function | NC contact |
| Minimum load current | 4 mA |

Piston detector, 3-pin (P3)
(short-circuit protection, intermittent and protected against polarity reversal, NC contact PNP)

| | |
|-----------------|------------------------------------|
| Design | with 4-point-LED, 3 pin connection |
| Rated voltage | 10 to 36 V DC |
| Residual ripple | ≤10% |
| Output function | PNP contact |

Cycle indicator, optical

| | |
|---------------------------|----------------|
| Ambient temperature range | -15 to + 75 °C |
| Operating pressure max. | 300 bar |

* The piston detector is designed for a service life of approx. 10-15 million cycles. This value may be significantly exceeded depending on the application, external environmental influences, medium, pressure, and cycle speed. Please consult the manufacturer if you have questions in this regard.

Fig. 7

Block metering device VPB with piston detector, for further technical data → page 5, fig. 6

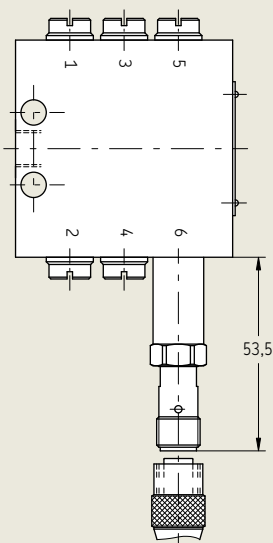
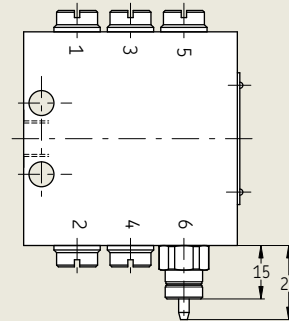

Fig. 8

Block metering device VPB with cycle indicator, for further technical data → page 5, fig. 6



Note
The cable socket of the piston detector must be ordered separately → see page 10.

Block metering device VPB

with 2/2 directional solenoid valve for grease



Fig. 9

Block metering device VPB with directional solenoid valve, for further technical data
→ page 5, fig. 6

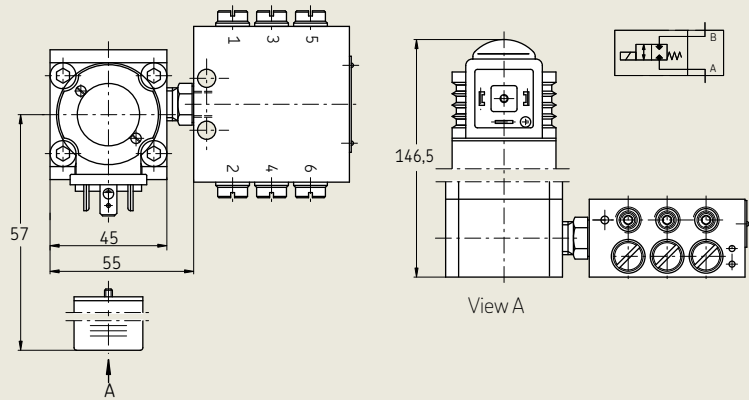

Technical Data

For further technical data → basic design, page 5

| | |
|---------------------------|---------------------------|
| Inlet thread connection | G1/4 |
| Ambient temperature range | -25 to +80 °C |
| Operating pressure max. | 300 bar |
| Lubricant | Grease up to NLGI-grade 2 |

2/2-directional solenoid valve

| | |
|-----------------------|--------------------------|
| Type | Spherical seat valve |
| Electrical connection | Plug / DIN43650-AF3 |
| Voltage | 24 V DC |
| Rated current | 0,67 A |
| Nominal output | 16 W |
| On-time | 100% ED (at max. +35 °C) |
| Protection class | IP 65 |
| Basic position | closed when de-energized |



Note

Line sockets must be ordered separately → page 10.

Order code

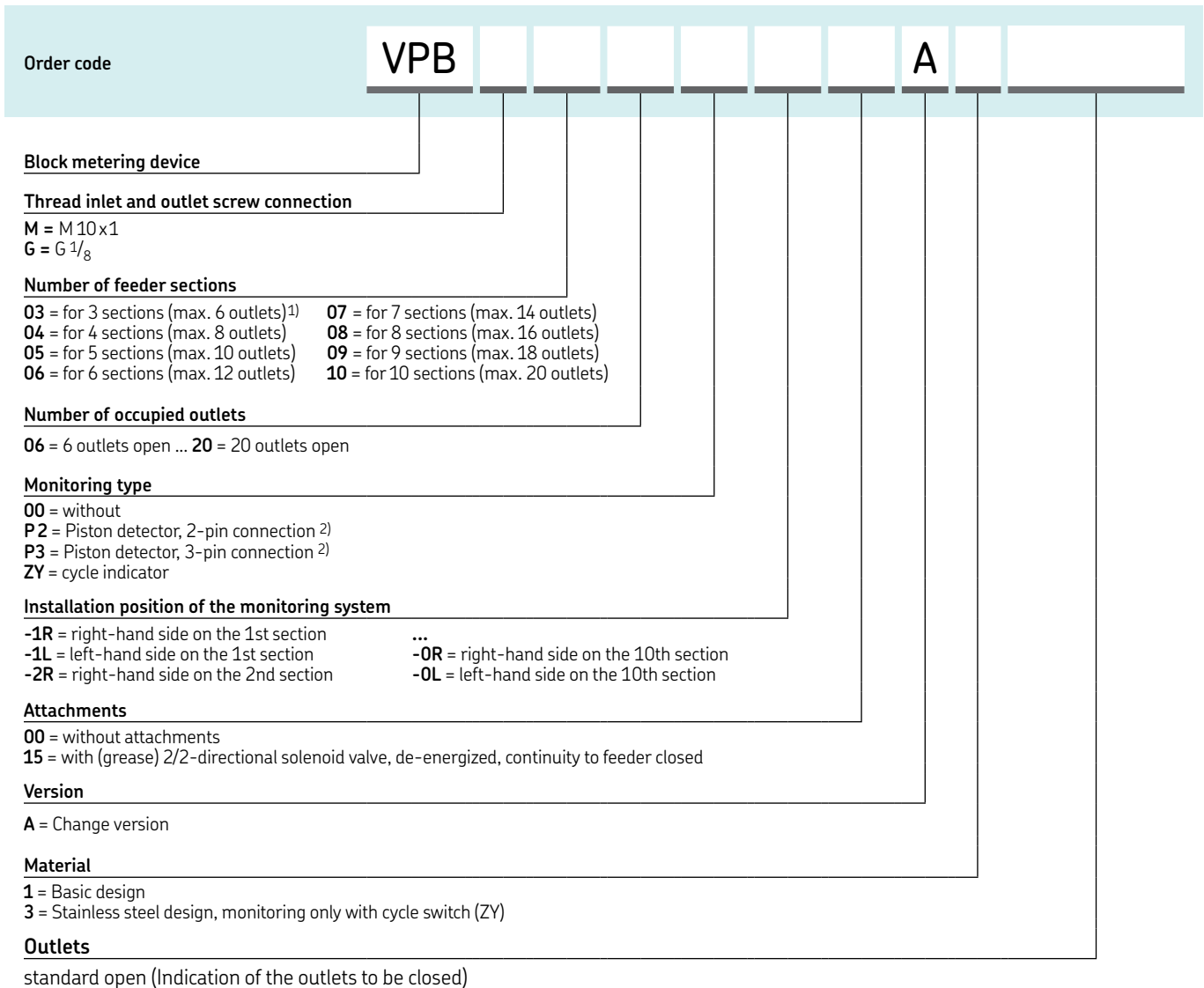

1) Use these progressive feeders only with check valve VPKM-RV-S4!
 2) only for basic design

Order example

VPB M / 10 16/ P3-9L /00 A1-3V-6V -8V

- Block metering device
- With inlet- and outlet thread
- 10 feeder pistons
- 16 outlets open
- Piston detector , 3-pin
- Installed on the left side of the 9th piston feeder
- Without attachments
- Change version A
- Basic design
- 3rd feeder outlet closed
- 6th feeder outlet closed
- 8th feeder outlet closed

! Note

Subsequently, only blocked lubricant outlets have to be declared. With a feeder outlet blocked, the internal plug has to be removed. The double volume is discharged on the opposing side.

Example of possible variations

Example of possible variations

for 1 to 6 lube points on one 3-section feeder

Crossporting versions

Example VPBM/VPBG

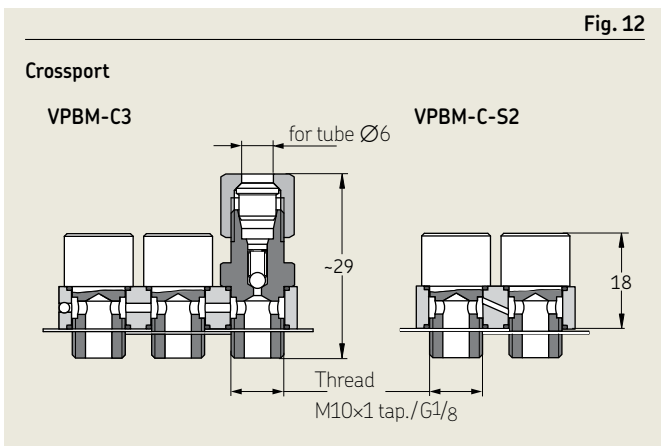
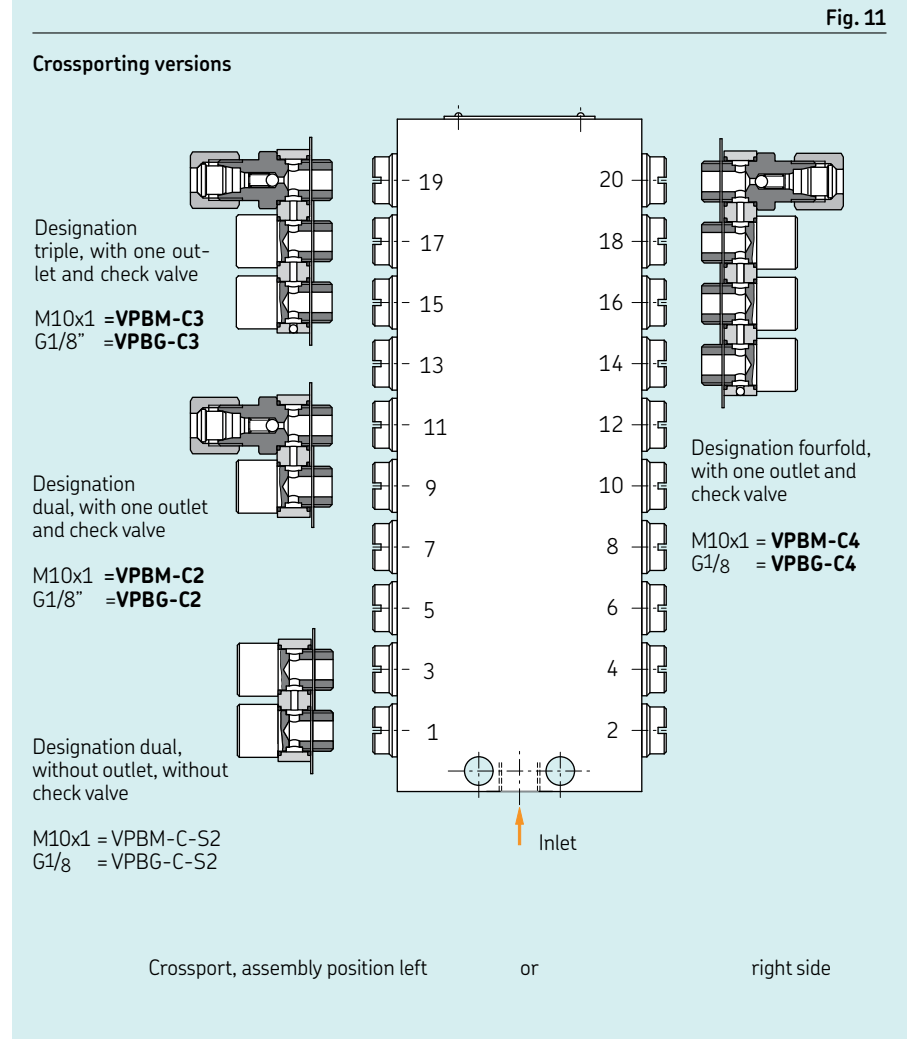
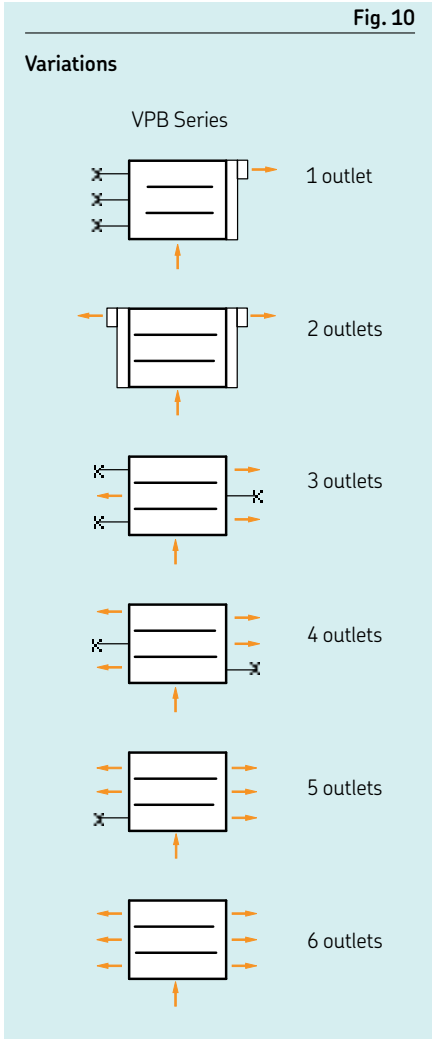

Table 4

Crossports for connecting nearby outlets

| Number of connecting Outlets | Order code for the complete crossport incl. hollow screws and connectors for tube Ø6 mm and check valve | | Order code for the complete crossport without fitting | |
|------------------------------|---|----------------|---|-------------------|
| | M10x1 | G1/8 | M10x1 | G1/8 |
| 2 | VPBM-C2 | VPBG-C2 | VPBM-C-S2* | VPBG-C-S2* |
| 3 | VPBM-C3 | VPBG-C3 | - | - |
| 4 | VPBM-C4 | VPBG-C4 | - | - |

* The crossporting version of the type VPBM-C is approved up to max. 100 bar operating pressure.

Accessories

Accessories

Check valves

| Order code | tube | | Opening pressure [bar] | pressure, max. [bar] | Fig. |
|--|------|------------|------------------------|----------------------|------|
| | ød1 | G | | | |
| for the direct screw-in in a feeder outlet | | | | | |
| VPKG-RV | 6 | R1/8 tap. | 3 | 100 | 13 |
| VPKM-RV-S4 | 6 | M10×1 tap. | 2 | 100 | |
| for plug-in connector | | | | | |
| VPKG-RV4-VS | 4 | R1/8 tap. | 3 | 300 | 14 |
| VPKG-RV-VS | 6 | G1/8 | 3 | 300 | |
| VPKM-RV-VS | 6 | M10×1 tap. | 3 | 300 | 15 |
| 226-10337-3 | 6 | M10×1 tap. | 3 | 350 | |

Fig. 13

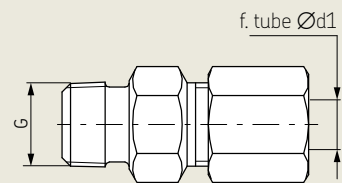

Fig. 14

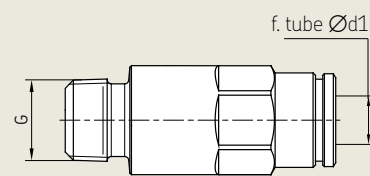
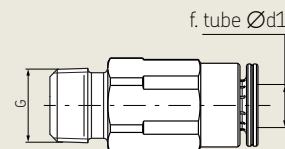

Fig. 15



Accessories

Electrical Plug-in connectors

| Order code | Specification |
|-------------|--|
| 179-990-416 | Rectangular plug DIN EN 175301-803A, for 2/2-way-valve, 2-pin with splashed cable; 3 m, 3×0.75 mm ² |
| 179-990-371 | Circular plug straight (A), Cable diameter 4–6 mm, 4-polig, max. 0.75 mm ² |
| 179-990-600 | Circular plug straight (B), 4-pin with splashed cable; 5 m, 4×0.25 mm ² |
| 179-990-372 | Circular plug angled (C), Cable diameter 4–6 mm, 4-pin, max. 0.75 mm ² |
| 179-990-601 | Circular plug angled (D), 4-pin with splashed cable, 5 m, 4×0.25 mm ² |

→ Brochure 1-1730-EN

Rectangular plug
179-990-416

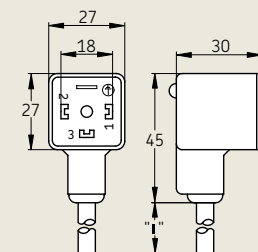

Circular plug M12×1



Spare parts

| Spare parts | |
|---|------------------------|
| Designation | Order code |
| Piston detector, 2-pin | 177-300-096 |
| Piston detector, 3-pin | 177-300-097 |
| Corresponding O-ring | WVN501-10x1.5 |
| 2/2-way valve, 24 V DC | 161-110-031+924 |
| Cable socket - 2/2 way valve | 24-1882-2029 |
| VPKM | |
| Screw connection G $\frac{1}{4}$ to M10x1 | 44-0159-2282 |
| O-ring | 504-019 |
| VPKG | |
| Screw connection G $\frac{1}{4}$ to G $\frac{1}{8}$ | 96-6013-0282 |



Important information on product usage

SKF and Lincoln lubrication systems or their components are not approved for use with gases, liquefied gases, pressurized gases in solution and fluids with a vapor pressure exceeding normal atmospheric pressure (1 013 mbar) by more than 0,5 bar at their maximum permissible temperature.



skf.com | skf.com/lubrication

® SKF is a registered trademark of the SKF Group.

© SKF Group 2018

The contents of this publication are the copyright of the publisher and may not be reproduced (even extracts) unless prior written permission is granted. Every care has been taken to ensure the accuracy of the information contained in this publication but no liability can be accepted for any loss or damage whether direct, indirect or consequential arising out of the use of the information contained herein.

PUB LS/P2 17587 DE · 1-3017-EN · August 2018