

Ecomag

Linear Actuator

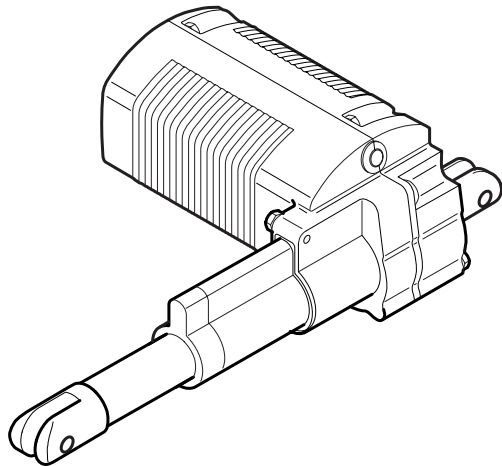

Read this manual before installing, operating or maintaining this actuator. Failure to follow safety precautions and instructions could cause actuator failure and result in serious injury, death or property damage.



Technical Instructions

Ecomag Linear drive

Content

1 General	.2
1.1 Using the Technical Instructions	.2
1.2 Explanation of symbols	.2
1.3 Correct usage	.2
1.4 Ambient conditions	.2
2 Function	.2
3 Installation and startup	.3
3.1 Scope of delivery	.3
3.2 Installation	.3
3.4 Startup	.4
4 Operation	.6
4.1 Controlling an actuator	.6
4.2 Locking device	.6
4.3 "Emergency lowering" in the event of a power failure (option)	.7
4.4 Rapid adjustment (optional)	.7
5 Maintenance and Care	.9
5.1 Maintenance	.9
5.2 Care	.9
5.3 Disposal	.9
5.4 Liability	.9
5.5 Technical data	.10
5.6 Troubleshooting	.10

Reference standards

- ▶ EN 60601-1
- ▶ EN 60601-1-2
- ▶ EN 60601-2-38
- ▶ EN 60335
- ▶ UL 2601

Magnetic Elektromotoren AG
 Oristalstrasse 97
 CH-4410 Liestal
 Phone +41/ 61/ 925 41 11
 Fax +41/ 61/ 921 37 04
 e-mail sales@magnetic.ch

1 General

1.1 Using the Technical Instructions

The Technical Instructions are intended for designers or specialists who use the ECO-MAG linear actuator in their products, and for fitters who work with the actuator. The Technical Instructions contain all relevant information on this Magnetic product.

We reserve the right to make changes which are in the interest of technical progress.

Please read the Technical Instructions carefully and, above all, pay careful attention to the Safety Instructions.

The Technical Instructions should be used for drawing up the User Manual for the end product.



This symbol is used to indicate operations and states which could endanger life and limb. Follow the instructions precisely!



This symbol provides the user with useful information.



This actuator must not be operated in potentially explosive atmospheres.



*The maximum load specified on the label must not be exceeded, since doing so will mean that the prescribed level of safety will not be provided.
The actuator may be destroyed if it is overloaded!*



The ECOMAG linear actuator "push version" (ECO 2/4/6/8) may only be subjected to compressive loads. If pull forces are applied, the push tube can disengage from the outer tube. Risk of accident!

1.2 Explanation of symbols

The symbols opposite are used in the Technical Instructions to highlight possible dangers and important notes.

1.3 Correct usage

The ECOMAG linear actuator has been designed for use in conjunction with the following Magnetic components:

- ▶ SEM 1 control unit and
- ▶ EHE handswitch

and is specifically intended for adjusting chairs and couches in medical and care sectors.

Other uses must be discussed with Magnetic Liestal.

1.4 Ambient conditions

Operation:

Temperature	10 °C to 40 °C
Humidity	max. 85%

Storage / transport:

Temperature	-20 °C to 60 °C
Humidity	max. 95%

The unit is only suitable for indoor use and must not be subjected to the elements.

2 Function

ECOMAG linear actuators are DC actuators with worm gears and spindle units. The gears convert the motor's rotational movement into a linear movement through the threaded spindle's rotation being transferred to a pushing tube via a special nut.

The stroke is limited by built-in limit switches.

The power is supplied via an attachable or externally fitted SEM 1 control unit. The control unit consists of a control box housing the transformer, the converter, up to 4 motor socket connections and a socket connection for the control device (e.g. handswitch).

The linear actuator is operated using a control device (e.g. an EHE handswitch).

The feed speed is a function of the load!

The ECOMAG can be loaded with push forces (ECO 2/4/6/8) or pull and push forces (ECO 3/5/7/9).

The maximum load on the actuator shown on the label refers to the centric push tube axis.

A mechanical anti-pinching device for pull forces is fitted in the "push" versions. In the "pull-push" versions, a mechanical anti-pinching device is available as an option. The self locking of the actuator is at least equal to the push-/pullforce.

3 Installation and startup

3.1 Scope of delivery

The ECOMAG actuator system comprises the following:

- ▶ Control unit
- ▶ Actuator and
- ▶ Control device

3.2 Installation

The linear actuator must only be installed over the two fork heads. The load must act centrally on the push tube axis and, when the actuator is installed, it must be free from any other mechanical forces.

If there is a risk of hitting a mechanical limit stop during a stroke movement, Magnetic AG recommends that mechanical anti-pinching protection or a current cut-off device be used.

When the rapid adjustment option is used, it must be ensured that the entire stroke movement can be completed.

Mounting position

As a general rule, all mounting positions are possible, provided the following points are noted:

If the control unit is plugged in, only the mounting positions shown in Fig. 1 from 0° to 90° are permitted.

If an overhang arrangement is used, the control unit must also be fixed in position with cable ties. The control unit can otherwise work itself loose.

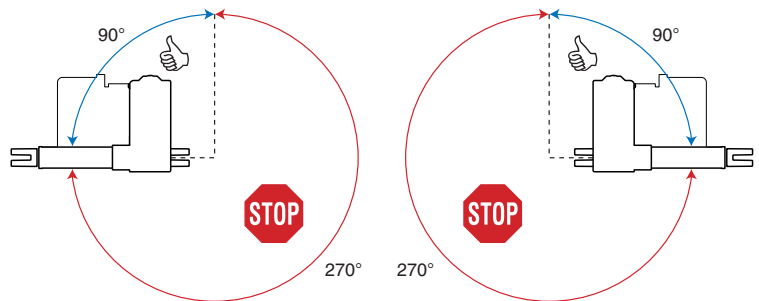
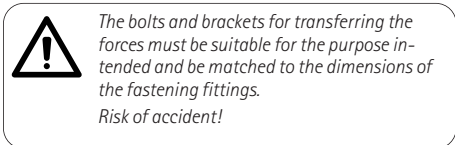

Fig. 1 – Mounting positions

Mounting the control unit on the actuator (ECO 2/3/6/7 only)

- ▶ Slide the control unit onto the actuator as shown in Fig. 2. The control unit locks into position with an audible click of the locking mechanism.

Removing the control unit

- ▶ Gently lift the nose with a screwdriver, and at the same time push the control box in the direction of the arrow (see Fig. 3).

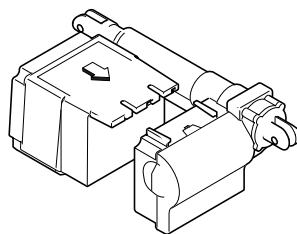

Fig. 2 – Mounting the control unit

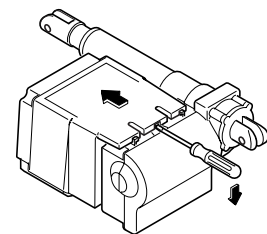
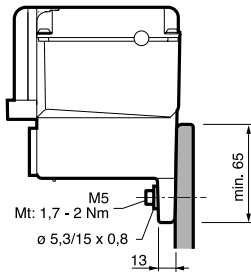

Fig. 3 – Removing the control unit

Fastening the control unit externally



The control unit must be installed at the installation slots provided (see Fig. 4), and must be installed so that it is free from mechanical forces and vibrations.

Tightening torque: 1.7 – 2 Nm

Fig. 4 – Fastening the control unit externally



To ensure that the grounding bolt (1) does not rotate too, it must be fixed in position using a wrench (item 5) when the device's earth connection is being tightened or unscrewed.
Risk of accident!

Installing / uninstalling the earth cable (option)

- ▶ Undo the nut (4) and contact washer (3) from the grounding bolt (1). (Fig. 5)
- ▶ Push the cable lug for M4 (2) of the device you wish to earth over the grounding bolt (1).
- ▶ Fasten the grounding bolt (1) onto the hexagon using the wrench (5).
- ▶ Screw the contact washer (3 and nut (4) onto the thread of the grounding bolt (1).
- ▶ Tighten with the torque wrench to 1.5 Nm – 1.8 Nm.

The cable is uninstalled in the reverse order.

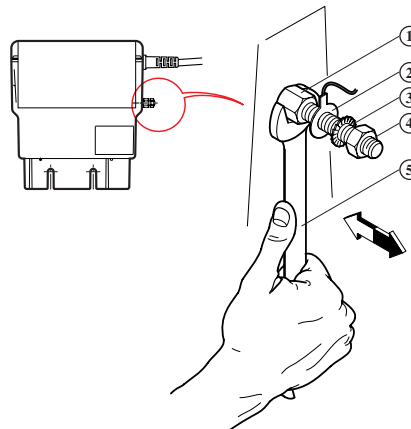

Fig. 5 – Installing / uninstalling the earth cable

3.4 Startup

Opening the control box cover



All cables must be secured so that no forces act on the control unit connections.
Incorrectly connected cables may become loose and damage the control unit!

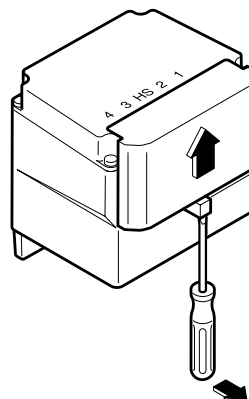

- ▶ Gently lift the nose with a screwdriver, and at the same time push the control box cover in the direction of the arrow.

Fig. 6 – Steuerkastendeckel öffnen



Motor connections that are not occupied on the control unit are sealed at the factory. The seals must not be removed. If liquid is allowed to penetrate the seals, the control unit will be damaged!

Connecting / disconnecting the actuator cable on the control unit

- ▶ Connect the actuator cable in the direction of the arrow (see Fig. 7).
- Note: Observe the plug number.
- ▶ Disconnect the actuator cable in the direction of the arrow (see Fig. 8).

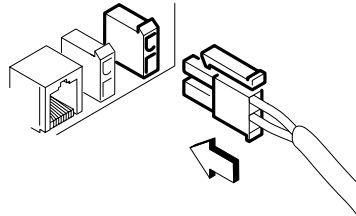

Fig. 7 – Connecting the cable

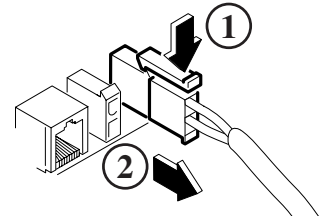

Fig. 8 – Disconnecting the cable



You should ensure that the handswitch cable plug is inserted correctly. If the front film is damaged (i.e. allowing liquid to penetrate), the handswitch must be replaced. The handswitch would be damaged if liquid were allowed to penetrate it!

Connecting / disconnecting the control device

- ▶ Connect the control device plug (e.g. handswitch) in the direction of the arrow (Fig. 9).
- Note: Observe the plug type.
- ▶ Disconnect the plug in the direction of the arrow (see Fig. 10).

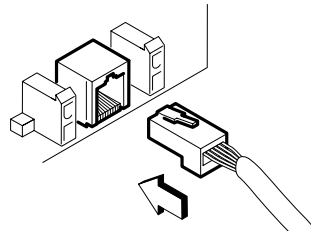

Fig. 9 – Connecting the cable

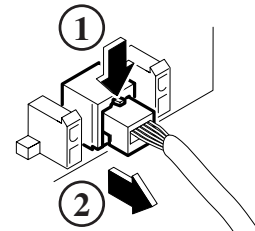
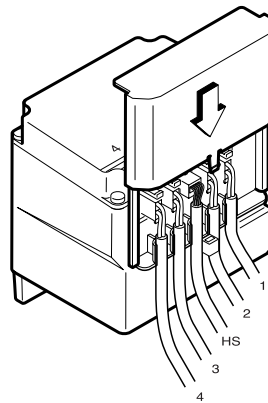

Fig. 10 – Disconnecting the cable



Protection class IPX4 is only guaranteed if the control box cover is closed with an audible click of the locking mechanism, and the seal edges and nose are not damaged.

Closing the control box cover



- ▶ Move the control box cover in the direction of the arrow (see Fig. 11).
- ▶ The control box cover is only closed once an audible click of the locking mechanism is heard.

Fig. 11 – Closing the control box cover

4 Operation

4.1 Controlling an actuator



If the feed speed of the linear actuator diminishes, or it no longer works under load, it must be uninstalled immediately and taken out of use.
Risk of personal injury!

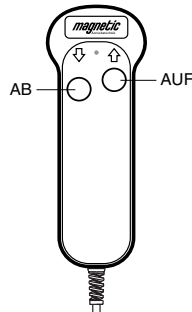

The EHE handswitch is used to actuate one or more ECOMAG linear actuators. A control panel is provided on the front foil of each handswitch for each actuator that is to be controlled (see Fig. 12). This consists of two push-buttons that are positioned offset from each other. On the front plate are the symbols which are assigned to the function and are used for adjusting the individual linear actuators.

Up to 4 linear actuators can be actuated separately.

Fig. 12 – Handswitch EHE

Pressing one of the push-buttons activates the relevant linear actuator. It moves for as long as the button is held depressed.

- ▶ Button The actuator extends
- ▶ Button The actuator retracts

Fastening hook

It is possible to retrofit the handswitch with a fastening hook.

The fastening hook is attached to the adhesive surface provided on the rear of the handswitch using adhesive film.

4.2 Locking device



To avoid inadvertent activation of the control device, we recommend the optional locking device (EHE3).

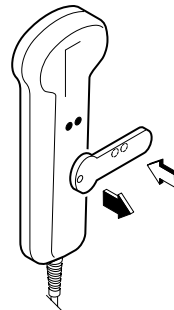

As an option, it is also possible to lock the individual actuators on the EHE handswitch. This gives the unit failure safety in accordance with EN 60601-2-38.

In Lock or Unlock programming mode, the locking key must always be placed in the bores situated on the rear of the handswitch.

Fig. 13 – EHE.. locking / unlocking the handswitch



After locking or unlocking, the locking key must be removed and the set functions checked.

Locking the handswitch

- ▶ Place the locking key with cam into the bore on the rear of the handswitch.
- ▶ Press the "DOWN" button of the actuator that is to be locked. The display lights up yellow.
The actuator is locked.

Unlocking the handswitch

- ▶ Verriegelungsschlüssel mit Nocken in die Bohrung auf der Rückseite des Handschalters legen.
- ▶ Press the "UP" button of the locked actuator. The display lights up green.
The actuator is unlocked.

4.3 "Emergency lowering" in the event of a power failure (option)

If the power fails, the actuators can be moved to their lower terminal position.

If the "EMERGENCY lowering" features a patient safety function in the event of a power failure, the user must ensure that:

- ↓ the battery capacity is satisfactory,
- ↓ the function is checked regularly by briefly pressing the "AB" ("DOWN") button.

The following batteries, which have been approved by the manufacturer, may be used:

- ↓ Panasonic 9 V Alkaline 6LR61,
- ↓ Varta 9 V Alkaline 6LR61 and
- ↓ Energizer 9 V Alkaline 6LR61

Changing the batteries

- ▶ Remove the cover (see Fig. 12).
- ▶ Replace the batteries.
- ▶ Replace the cover with the line mark facing upwards.

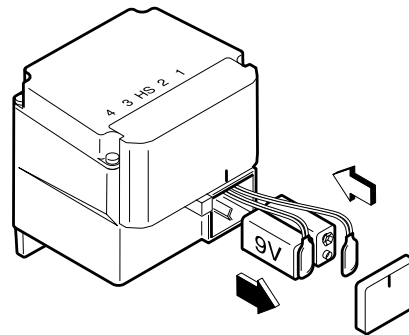

Fig. 12 – Opening / closing the battery cover



Magnetic AG, Liestal, recommends that the batteries be replaced each time the "EMERGENCY lowering" function is used. Damaged, spent batteries must be replaced anyway.



Batteries must be disposed of correctly or returned to Magnetic Liestal AG. They must not be disposed of in the general household waste!



Protection class IPX4 is only guaranteed if the marking on the cover matches the marking on the housing.

4.4 Rapid adjustment (optional)

Function

The rapid adjustment function is used for "emergency rapid lowering" of the head or the foot of the bed (during patient resuscitation).

If a power failure or actuator malfunction should occur, or for beds which are not connected to a power supply, the rapid adjustment device can be used to manually lower the head or foot of the bed (further option).

When installing an actuator with rapid adjustment function, a warning notice (Fig. 13) in accordance with EN 60601-1, Section 6.3c and 6.4, must be attached clearly to the end product (insofar as the end application is subject to this standard).



The rapid adjustment function should only be used in emergencies, or to test that it is working properly.

When retracted, the actuator must lie against a fixed limit stop (e.g. bed frame), since otherwise the actuator may be damaged by a rapid-lowering action.

No transverse forces (misaligned mounting) must be allowed to act on the linear actuator, since otherwise the function of the rapid adjustment feature cannot be guaranteed.

The screws in the pivot clamp must not be tightened or loosened!



The rapid adjustment function must be checked every 6 months.

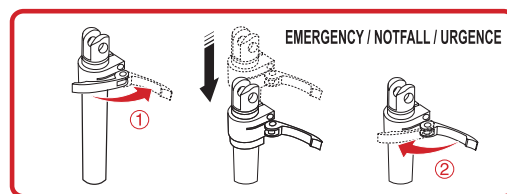

Fig. 13 – Warning notice for rapid adjustment



The emergency lowering mechanism must not be treated with oil, grease or any other lubricating substance, since this can lead to it becoming dangerously easy to move!



It must be ensured that no objects can hinder the lowering action.

The minimum actuation force on the actuator for rapid adjustment must be at least 1200 N. Inadvertent actuation of the clamping lever must be ruled out.

If the backrest or footrest of the bed is adjusted and released manually, the actuator will move back to its starting position.

Risk of pinching / injury!

Usage

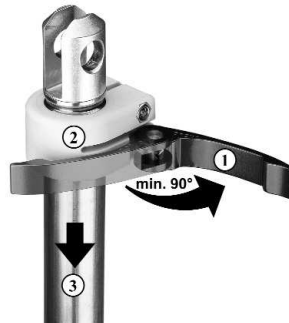

Fig. 14 – Opening the clamping lever



Fig. 15 – Closing the clamping lever

- ▶ Open the red clamping lever (see Fig. 14, (1)). While doing so, hold the head of the bed firmly. Depending on the bed design, the head or foot can lower quickly.
- ▶ Manually press the rapid adjustment mechanism downwards (see Fig. 16, (3) e.g. backrest).
- ▶ Close the red clamping lever (see Fig. 15, (1)) until it reaches its end position (4).

You must ensure that, whatever position the clamping lever is in, it can be actuated as shown in Figs. 14 and 15.



Fig. 16 – Pushing the head or foot of the bed downwards

After a rapid lowering action, the clamping lever must be in closed position before the linear actuator is used again.



The maximum current consumption under full load must be measured. It must not exceed the value specified on the label. Higher current consumption means that the linear actuator is overloaded and may be damaged!



Ensure that no liquids are allowed to penetrate the connections!



Washing water with chemical additives must be pH neutral. Excessively acidic or alkaline washing water can permanently damage the metal and plastic components of the actuator. High-pressure steam cleansing equipment must not be used.

5 Maintenance and Care

5.1 Maintenance

The actuators may only be opened and worked on by the Magnetic Customer Service.

The fork heads, housing and power cable must be checked for mechanical damage (e.g. cracks) every 6 months.

The user must undertake to monitor the products vigilantly.

The actuators are greased with Magnetic-approved lubricants, and do not require any maintenance for the following service life:

Service life: Max. 10,000 double-strokes with a stroke of 200 mm.

(The question of how the double-stroke specification is translated into a useful service life must be defined by the manufacturer of the end product).

When the service life expires, the actuator must be removed and overhauled by the manufacturer. Risk of personal injury!

For applications where it is highly likely that the service life will be exceeded, we recommend the use of the optional safety nut.

The rapid adjustment option must be checked every 6 months. If excessive force is needed to move the actuator, or it runs too freely, it should be exchanged.

Duty cycle

The actuator has been designed for intermittent operation (see label). If a higher duty cycle is used, please contact the Magnetic factory.

Thermofuse

The ECOMAG linear actuator is fitted with a thermofuse. The thermoswitch integrated into the motor switches the actuator off if the temperature becomes excessive.

5.2 Care

Protection from water, cleaning, disinfecting

The following protection classes are only guaranteed in assembled status:

- ▶ Linear actuator and control unit IP X4
- ▶ Housing of the optional mains disconnection device IP X0
- ▶ Handswitch IP X6 und IP X7

Clean after use in order to avoid the accretion of residues!

The actuator may be cleaned with a damp cloth and water. Add a little isopropyl alcohol if necessary.

5.3 Disposal

The actuators and control unit components may be returned to Magnetic Liestal AG for disposal.

5.4 Liability

In every case, the owner or operator of the unit shall be liable for its function if it has been incorrectly maintained or repaired by persons who are not employed by the Magnetic Service Department or if the unit has not been operated in accordance with the specified application.

Magnetic Aktiengesellschaft shall not be liable for any damage resulting from failure to observe these instructions. These instructions shall not be regarded as an extension of the warranty and liability terms set out in the Conditions of Sale and Supply applied by Magnetic Aktiengesellschaft.

The product is not subject to the labelling requirements of the CE or EMC guidelines. The required EMC measures for the end product must be met by its manufacturer, taking into account installation factors, wiring and control, and these must be checked for compliance with the intended application.

Observance of these instructions is the responsibility of the manufacturer of the machine or equipment.

5.5 Technical data

See brochure 530D, 2400 and the type designation on the label.

5.6 Troubleshooting

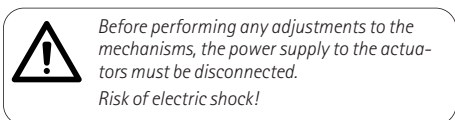

Fault	Cause	Remedy
Actuator(s) not working	Control unit not plugged in	Plug in the mains cable.
	Poor connector contact	Plug in the power, control device or motor plug correctly
	Actuator faulty	Return the actuator to the Magnetic Service Department
	Control device faulty	Replace the control device
	Control unit faulty	Replace the control unit
	Actuator overheated	Wait 20 minutes
	Actuator not plugged in	Plug in the motor cable
Markedly reduced speed	Motor, gears or nuts faulty	Return the actuator immediately to the Magnetic Service Department
Very loud running noise	Motor, gears or nuts faulty	Return the actuator immediately to the Magnetic Service Department
Actuator only runs in one direction	Cut-off faulty	Return the actuator to the Magnetic Service Department
	Control device faulty	Replace the control device
	Control unit faulty	Replace the control unit
Control unit not working	Control unit not plugged in	Plug the mains cable in
	Control unit faulty	Return the control unit to the Magnetic Service Department.
	Mains cable faulty	Return the control unit to the Magnetic Service Department.
	Control device faulty	Replace the control device
	Poor connector contact	Fit the plug correctly.
Control device not working	Poor connector contact	Fit the plug correctly

If you are unable to eliminate a fault, contact the Magnetic Service Department.