

# CLK lubrication system

Airless oil projection system for conveyor roller chain lubrication

Date of issue	<b>January 2020</b>
Form number	<b>951-130-452</b>
Read manual prior to installation or use of this product. Keep manual nearby for future reference.	

# Imprint

In accordance with the EU Machine Directive 2006/42/CE, the installation and operation instructions are an integral part of a lubrication system and must be kept close to the equipment for future reference.

The installation and operation instructions were drafted in compliance with the applicable standards and rules governing technical documentation.

© SKF

This documentation is protected by copyright. All rights reserved. The photomechanical reproduction, copying, and distribution of this documentation or parts thereof by means of processes such as data processing, data carriers, and data networks is strictly prohibited without the express permission of SKF.

Subject to editorial or technical modifications.

English translation of the original manual in French.

# Service

For all technical questions, please contact:

SKF France  
Lubrication Product Division  
204, bld Charles de Gaulle  
B.P. 239  
37540 St-Cyr-sur-Loire  
FRANCE  
Tel. +33 (0) 247 403 087  
lubrication-france@skf.com

Or an SKF Service Center, the addresses of which are given on our website:

[www.skf.com/lubrication](http://www.skf.com/lubrication)

# Training courses

In order to provide a maximum of safety and economic viability, SKF carries out detailed training courses. It is recommended that the training courses are attended. For more information please contact the SKF Service Center or the local SKF representative.

# Warranty

The manual does not contain any information on the warranty. This can be found in our General Conditions of Sales. The General Conditions of Sales are available at: [www.skf.com/lubrication](http://www.skf.com/lubrication).

# Disclaimer

The manufacturer shall not be held responsible for damages caused by:

- non appropriate use faulty assembly, operation, setting, maintenance, repair or accidents
- use of inappropriate lubricants
- improper response to malfunctions
- unauthorized modifications of the product
- intent or negligence
- use of non-original SKF spare parts.
- improper planning or design of a centralized lubrication system

Liability for loss or damage resulting from the use of our products is limited to the maximum purchase price. Liability for consequential damages of whatever kind is excluded.

# Contents

Imprint .....	2
Service .....	2
Training courses .....	2
Warranty .....	2
Disclaimer .....	2
General .....	4
Information concerning the EC Declaration of Incorporation .....	5
1. Safety instructions .....	6
1.1 General safety instructions .....	6
1.2 General behaviour when handling the product .....	6
1.3 Qualified technical personnel .....	6
1.4 Electric shock hazard .....	6
1.5 System pressure hazard .....	7
1.6 Function .....	7
1.7 Assembly, maintenance, malfunctions, shutdown, disposal .....	7
1.8 Intended use .....	7
1.9 Foreseeable misuse .....	7
1.10 Applicable documents .....	7
2. Lubricants .....	8
2.1 General .....	8
2.2 Selection of lubricants .....	8
2.3 Approved lubricants .....	8
2.4 Lubricants and the environment .....	9
2.5 Danger relating to lubricants .....	9
3 Design and function .....	10
3.1 General .....	10
3.2 Versions .....	10
3.3 Construction .....	10
3.3 Function .....	13
4. Technical data .....	14
5. Transport, delivery and storage .....	15
5.1 Transport .....	15
5.2 Delivery .....	15
5.3 Storage .....	15
6. Installation instructions .....	16
6.1 General .....	16
6.2 Position .....	17
6.3 Installation .....	18
6.4 Hydraulic connections .....	21
6.5 Electrical connections .....	22
7. Commissioning .....	24
7.1 General .....	24
7.2 Control Unit .....	24
7.3 Bleeding .....	29
7.4 Reservoir filling .....	29
7.5. Commissioning .....	30
8 Maintenance .....	31
9. Failures .....	32
11 Shutdown .....	34
11.1 Temporary shutdown .....	34
11.2 Permanent shutdown .....	34
12. Spare parts .....	34

# General

## Meaning of symbols and corresponding information

In this manual, the symbols and safety wordings shown on this page are intended to communicate a particular risk to persons, material assets, or the environment.

All safety instructions must be respected by person exposed to these risks. The safety instructions must be communicated to all other persons.



Instructions attached directly to the equipment, such as

- rotational direction arrows
- fluid connection labels, etc.

must be respected and remain perfectly legible.

It is essential to read these instructions thoroughly and to respect the safety instructions given.

### Legend

Warning level	Consequence	Probability
 <b>DANGER</b>	Death, serious injury	imminent
 <b>WARNING</b>	Death, serious injury	possible
 <b>CAUTION</b>	Minor injury	possible
<b>NOTE</b>		

# Information concerning the EC Declaration of Incorporation

## EC Declaration of Incorporation in accordance with EC-Machinery Directive 2006/42/EC, Appendix II Part B

The manufacturer SKF France SAS, 204, Bld Charles de Gaulle, B.P. 239 – 37540 St-Cyr-sur-Loire – FRANCE, declares herewith the conformity of the partly completed machine

Designation: Grease injection lubrication system for chains  
Type: CLK  
Order No.: see ID plate  
Year of construction: see ID plate

with the following essential health and safety requirements of the EC Machinery Directive 2006/42/EC when released on the market.  
1.1.2 · 1.13 · 1.3.2 · 1.3.4 · 1.5.1 · 1.5.6 · 1.5.8 · 1.5.9 · 1.6.1 · 1.7.1 · 1.7.3 · 1.7.4

The relevant technical documentation is compiled in accordance with part B of Annex VII of this Directive. We undertake to transmit in electronic format the relevant technical documentation in response to a reasoned request by the competent national authorities. The person empowered to draw up the declaration is the technical standards manager. See the manufacturer's address.

Furthermore the followings directives and (harmonized) standards have been applied.

2011/65/EC	RoHS II
2014/30/EU	Electromagnetic compatibility   Industry
IEC 61010-01: 03/2001	Safety compliance
IEC 61010-01: 2010	Safety compliance
EN 61000-6-4: 2007/A1: 2011	Electromagnetic compatibility (EMC) – Part 6-4 : Generic standards – Emission standard for industrial environments
NF EN 60529 (2000)	Degrees of protection provided by enclosures

The partly completed machine must not be put into service until the final machinery into which it is to be incorporated has been declared in conformity with the provisions of the EC Machinery Directive 2006/42/EC and other relevant Directives.

St Cyr-sur-Loire, June 9<sup>st</sup>, 2018



Laurent Aulay  
Product innovation manager  
SKF France  
Lubrication Product Division



Gérard Gaudin  
Production unit manager  
SKF France  
Lubrication Product Division

# 1. Safety instructions

## 1.1 General safety instructions

The owner must ensure that safety information has been read by any persons entrusted with works on the product or by those persons who supervise or instruct the before-mentioned group of persons. In addition, the owner must also ensure that the relevant personnel are fully familiar with and have understood the contents of the Instructions.

The manual must be kept at hand along with the product.

Note that the manual is part of the product and must accompany the product if sold to a new owner.

The described products were manufactured according to the state of the art. Risks may, however, arise and may result in harm to persons or damage to material assets.

Any malfunctions which may affect safety must be remedied immediately. In addition to the manual, general statutory regulations and other regulations for accident prevention and environmental protection must be observed and applied.

## 1.2 General behaviour when handling the product

- The product may be used only in awareness of the potential dangers, in proper technical condition, and according to the information in this manual.
- Specialists must familiarize themselves with the functions and operation of the product. The specified assembly and operating steps and their sequences must be observed.
- Any unclear points regarding proper condition or correct assembly/operation must be clarified. Operation is prohibited until issues have been clarified.
- Unauthorized persons must be kept away.
- Precautionary operational measures and instructions for the respective work must be observed.
- Responsibilities for different activities must be clearly defined and observed. Uncertainty seriously endangers safety.
- Safety-related protective and emergency devices must not be removed, modified or affected otherwise in their function and are to be checked at regular intervals for completeness and function. If protective and safety equipment has to be dismantled, it must be reassembled immediately after finishing the work, and then checked for correct function.
- Remedy occurring faults in the frame of responsibilities. Immediately inform your superior in the case of faults beyond your competence.
- Wear personal protective equipment.
- Observe the relevant safety data sheets when handling lubricants.

## 1.3 Qualified technical personnel

Only qualified technical personnel may install, operate, maintain, and repair the products described in the manual. Qualified technical personnel are persons who have been trained, assigned and instructed by the operator of the installation. These persons are considered capable of such tasks due to their education, training, and experience with valid standards, conditions, accident prevention regulations in effect, and installation conditions. They should be able to carry out the required tasks and to recognize – and thus avoid – any dangers that might otherwise occur. The definition of qualified electricians and the prohibition against employing non-qualified personnel are laid down in DIN VDE 0105 and IEC 364.



Relevant country-specific qualifications for technical personnel apply for countries outside the scope of IEC 364.

The core principles of these country-specific qualification requirements for technical personnel cannot be below those of the two standards mentioned above. The operator of the final product is responsible for assigning tasks and areas of responsibility and for the responsibility and monitoring of the personnel. These areas must be precisely specified by the operator.

The personnel must be trained and instructed if they do not possess the requisite knowledge.



Product training can also be performed by SKF in exchange for costs incurred.

## 1.4 Electric shock hazard

		<b>CAUTION</b>
	<b>Electric shock</b>	Working on products that have not been disconnected from the power supply can cause serious injury to persons and material damages. Installation, maintenance, and repair work may only be carried out by qualified experts on products that are not connected to a power supply.

Electrical connections for the described product may only be established by qualified and trained personnel authorized to do so by the operator, and in observance of the local conditions for connections and local regulations (e.g. VDE/ IEC).

## 1.5 System pressure hazard

 <b>WARNING</b>	
	<b>System pressure</b> The product is pressurized during operation. The product must therefore be depressurized before starting assembly, maintenance, or repair work

## 1.6 Function

The following must be observed during commissioning and operation.

- All information within this manual and the information within the referenced documents.
- All laws/ regulations that the operator must observe.

## 1.7 Assembly, maintenance, malfunctions, shutdown, disposal

- All relevant persons (e.g., operating personnel, supervisors) must be informed of the activity prior to the start of work. Precautionary operational measures/ work instructions must be observed.
- Ensure through suitable measures that moving/ detached parts are immobilized during the work and that no body parts can be pinched by unintended movements.
- Assemble the product only outside the operating range of moving parts, at an adequate distance from sources of heat or cold.
- Prior to performing work, the product and the machine/ system in which the product is or will be integrated must be switched off and secured against unauthorized activation.
- All work on electrical components may be performed only with voltage-insulated tools.
- Ensure proper grounding of the product.
- Drill required holes only on non-critical, non-load bearing parts.
- Other units of the machine must not be damaged or impaired in their function by the installation of the product.
- No parts may be subjected to torsion, shear, or bending.
- Use suitable lifting gear when working with heavy parts.
- Avoid mixing up/ incorrect assembling of disassembled parts. Label parts.

## 1.8 Intended use

The product is designed for the lubrication of moving conveyor chains. Lubricant is squirted without air straight on lubrication

points. Product may only be used following the specifications, technical data and limits stated in this manual. Other use or use beyond this purpose is considered unintended.

## 1.9 Foreseeable misuse

A usage of the product differing from the aforementioned conditions and stated purpose is strictly prohibited. Particularly prohibited are:

- use in an explosive atmosphere (according to guideline ATEX 2014/34/EU)
- use without integrated pressure-limiting valve
- in continuous operation
- to supply, transport, or store hazardous substances and mixtures in accordance with annex I part 2-5 of the CLP regulation (EC 1272/2008)
- to feed, forward, or store gases, liquefied gases, pressurized gases in solution and fluids with a vapor pressure exceeding normal atmospheric pressure (1013 mbar) by more than 0,5 bar at their maximum permissible temperature.
- for the supply, transport, stockpiling of oils and greases containing glycol or polyglycol. These may damage the reservoir.

## 1.10 Applicable documents

In addition to this manual, the following documents must be observed by the respective target group:

- Operational instructions and approval rules
  - Safety data sheet (MSDS) of the lubricant used
  - Instructions from suppliers of purchased parts, project planning documents and other relevant documents.
- The operator must supplement these documents with applicable regulations for the country of use. This documentation must be included, if the product is sold or transferred.

## 2. Lubricants

### 2.1 General

#### NOTE

All SKF products must only be used for their intended purpose and in accordance with the specifications of the installation instructions for the product in question.

The intended use of this product is for the centralized lubrication/lubrication of bearings and wear points with lubricants. All physical limitations of use stipulated in the documentation of the product such as the owner's manual, technical drawings and catalogs must be observed.

More specifically, we call your attention to the fact that substances and mixtures classified as hazardous by the Annex I part 2-5 of the CLP regulation (EC 1272/2008), and identified with hazard pictograms GHS01-GHS06 and GHS08, can only be used to feed the SKF centralized lubrication systems, transported or distributed by these systems after consultation with SKF and obtaining written permission.

All products manufactured by SKF are not approved for use in conjunction with gases, liquefied gases, pressurized gases in solution and fluids with a vapor pressure exceeding normal atmospheric pressure (1013 mbar) by more than 0,5 bar at their maximum permissible temperature.

Should there be a need to use the product to convey media other than lubricants or hazardous substances, this must be discussed with SKF first and the company must give express written permission.

In the opinion of SKF, lubricants constitute a design element that must be considered when selecting components and designing centralized lubrication systems. The lubrication properties of the lubricants in question must be considered.

### 2.2 Selection of lubricants

#### NOTE

You must observe the machinery manufacturer's information on the lubricants to be used in the machinery.

#### NOTE

The manufacturer of the chain to be lubricated will specify the lubricant requirements for each point to be lubricated. You must make sure that the required quantity of lubricant is provided to the relevant lubricating point. If a lubricating point is insufficiently lubricated, the bearing may become damaged or jammed.

While the machinery/bearing manufacturer usually specifies lubricants, it is the owner/operator (or maintenance person) who must finally select the appropriate lubricant, with the help of the lubricant supplier. When selecting a lubricant, the type of bearing/wear point, the stresses and strains to be expected during operation, and anticipated ambient conditions must be taken into account. All financial/economic aspects must also be considered.

#### NOTE

If required, SKF can help customers to select suitable components for the conveyance of the selected lubricant and to plan and design their centralized lubrication system.

If you have further questions, you can contact SKF.

We can test lubricants in our own laboratory to establish their suitability for conveyance (e.g. 'oil separation' behavior) in centralized lubrication systems.

You can request an overview of lubricant tests offered by SKF from our Service Center.

### 2.3 Approved lubricants





#### CAUTION



Only lubricants that have been approved by SKF for use with the product may be used. Unsuitable lubricants can cause product malfunctions and damage to property.





	 <b>CAUTION</b>
	Different lubricants must not be mixed together. Doing so can cause damage and require extensive cleaning of the products/centralized lubrication system. To prevent confusion, we recommend that you attach information indicating the lubricant to be used on the lubricant reservoir.

The described product can be operated with lubricants that comply with the specifications in the technical data.



Note that some lubricants may have properties that lie within the permitted limit values and yet not be suitable for use in centralized lubrication systems for other reasons. For example, some synthetic lubricants are not compatible with elastomers.

## 2.4 Lubricants and the environment

	 <b>WARNING</b>
	Lubricants can contaminate ground and watercourses. Lubricants must be used and disposed of in compliance with the rules. Instructions and local regulations must be observed when handling lubricants.

Note that lubricants are harmful to the environment and flammable; their transportation, storage, and processing are subject to special precautionary measures. For specifications on transportation, storage, processing, and dangers to the use and the environment for the lubricant, refer to the material safety data sheet provided by or available from the lubricant manufacturer. You can ask the manufacturer of the lubricant for the material safety data sheet.

## 2.5 Danger relating to lubricants

	 <b>CAUTION</b>
	Centralized lubrication systems must be absolutely leak-free. Leaking centralized lubrication systems can cause a slip hazard. When performing installation, maintenance, and repairs test the centralized lubrication system for leaks. Leaky parts of the centralized lubrication system or components of the lubrication equipment have to be sealed immediately.

Leaking centralized lubrication systems or components of the lubrication equipment are a source of danger in relation to slip hazard and the risk of injury. These dangers can cause physical injury to persons or damage to other material assets.

Lubricants are hazardous substance. It is essential to respect any safety instructions given in the lubricant safety data sheet. You can ask the manufacturer of the lubricant for the material safety data sheet.

# 3 Design and function

## 3.1 General

CLK lubrication systems have a central unit and all electrical and hydraulic components necessary to operate a lubrication system by airless oil projection. The central unit comprises a housing with an electromagnetic pump and an integrated control unit and a reservoir. Their compact design makes it very easy to implement the CLK lubrication systems as close as possible to the lubrication points located on a moving chain.

## 3.2 Versions

The CLK lubrication system can be sold as a kit, mainly containing:

- the CLK central unit
- the projection nozzles
- the inductive proximity sensor
- the lubricant lines
- etc.

The table 1 gives an overview of the several existing kits

# 3.3 Construction

## 3.3.1 Central unit

The central unit (→ fig. 1) is a compact group comprising a reservoir mounted on a pump housing.

The pump housing houses an electromagnetic pump and an integrated control unit. The control unit can be controlled and monitored from the control panel located on the housing front side. For more information on the control unit, refer to the section 6.2 Control unit.

The unit electrical connections are located under the rear part of the housing. It comprises three connectors (power supply, proximity sensor and fault outputs). A fourth connector can be optionally added to check the lubricant level.

The hydraulic outlets (lubricant) are located on the housing side.

The reservoir, with a usable capacity of 7.5 l, is made of translucent plastic to facilitate the control of the lubricant level.

Four mounting plates, placed on the reservoir rear side (x2) and on the pump housing rear side (x2) allow the easy mounting of the central unit against a wall or the machine wall.

## 3.3.2 Lubrication system kits

The complete kit of the CLK lubrication system includes, in addition to the central unit, different accessory subsets:

- long pipe
- short pipe
- nozzles
- inductive proximity sensor

Table 1

### Order information, oil lubrication system

Kit No.	Central unit		Nozzle 1)		Proximity switch 1)		Tube 1)	long	
	Flow rate	Outlets	Single	Double	Ø	Temperature			
CLK-460R-100+XXX 2)	60	4	–	4	12	-40 to +85 °C	7 mm	1	1
CLK-260R-100+XXX 2)	60	2	–	2	12	-40 to +85 °C	7 mm	1	–
CLK-460R-110+XXX 2)	60	4	–	4	18	-20 to +180 °C	8 mm	1	1
CLK-430R-101+XXX 2)	30	4	4	–	12	-40 to +85 °C	7 mm	1	1
CLK-430R-121+XXX 2)	30	4	4	–	2	-40 to +85 °C	4 mm	1	1

\*) For more information on subsets, see technical data

2) The order number has to be completed with the voltage key of the central unit: **428** for 230 V AC, 50/60 Hz and **429** for 115 V AC, 50/60 Hz

Fig. 1

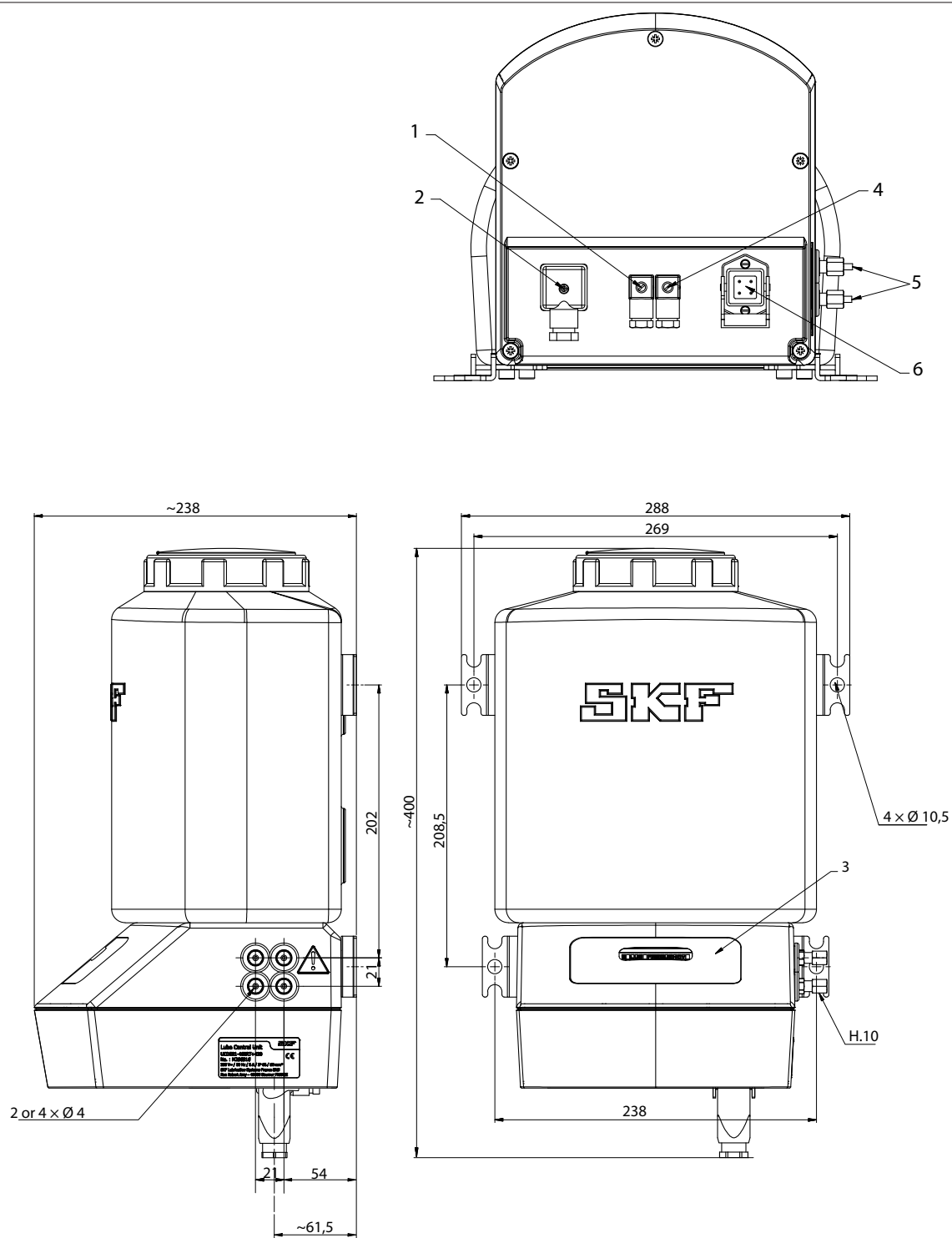

**CLK central unit**

- 1 Level-contact connector (according to the version)
- 2 Fault output connector
- 3 Control panel of control unit
- 4 Proximity sensor connector
- 5 Lubricant outlets
- 6 Power supply connector

Fig. 2

Projection nozzles with proximity sensor mounted on a support

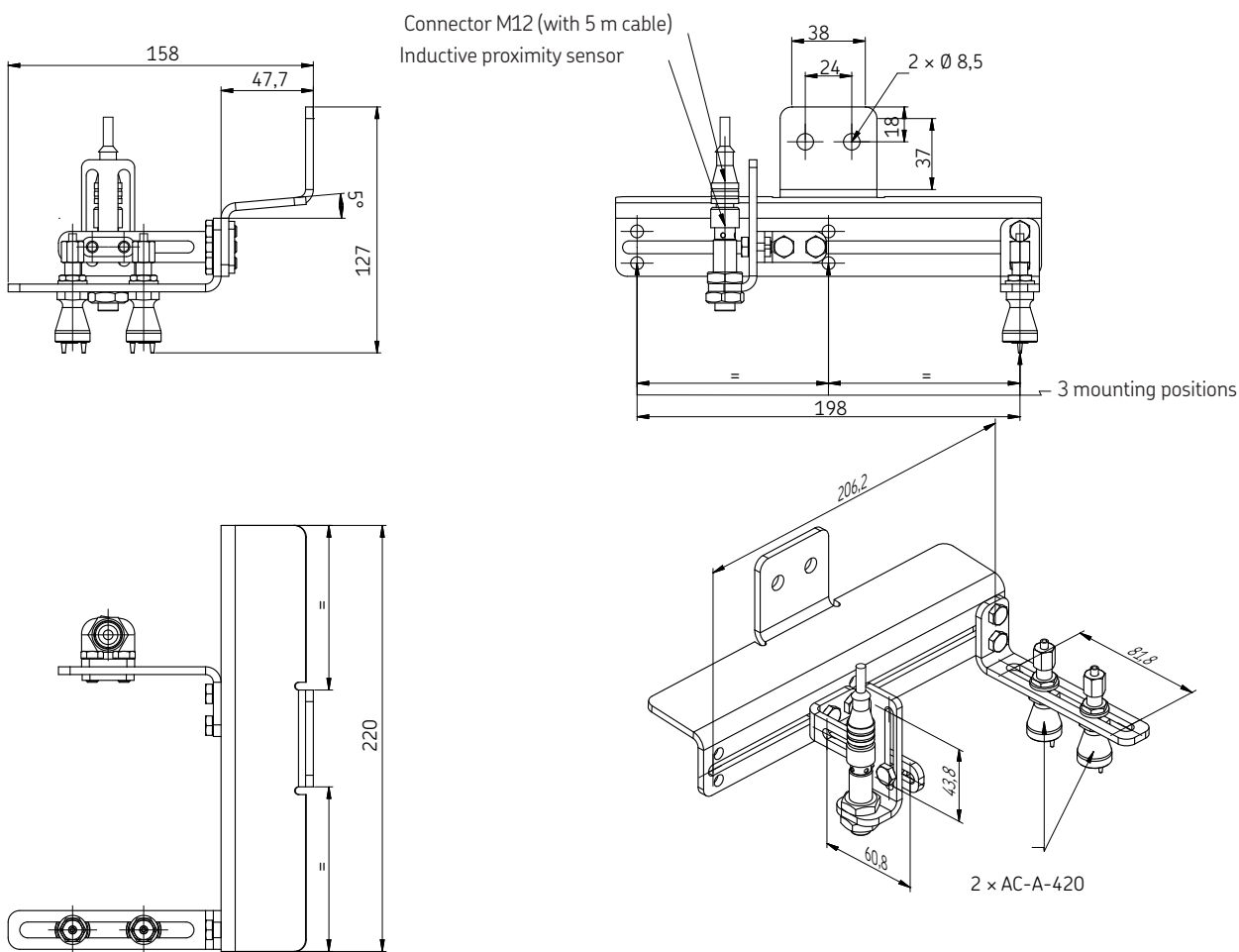
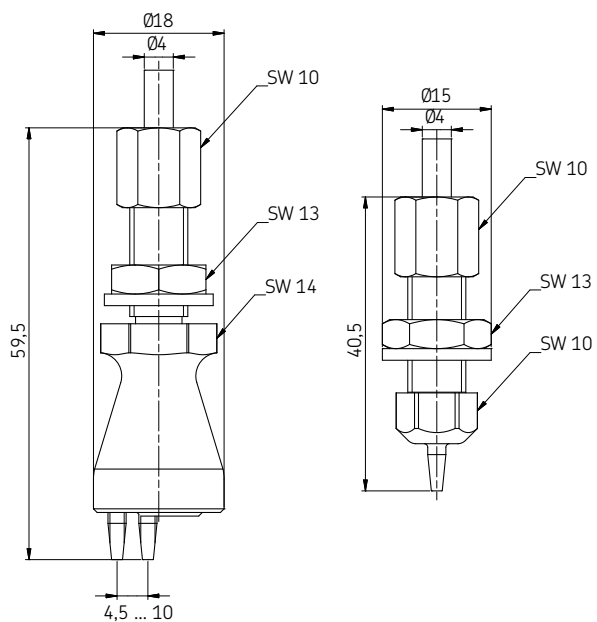

Fig. 3

Projection nozzles



## 3.3 Function

The CLK-type lubrication systems for conveyor chains generally comprise a piston pump with electromagnetic control, an oil reservoir and a control unit. The lubricant is supplied to the lubrication points by means of projection nozzles.

### 3.3.1 Oil projection

With these systems the lubricant is projected to the lubrication point without any mechanical contact.

Lubrication is done while the chain is moving.

For optimal oil projection, very small amounts of oil should be projected at a specific time on the chain lubrication point. A proximity sensor is used to accurately determine the position of the chain, the rollers and the links, and so the exact time for projecting the lubricant. When the lubrication point is detected, the control unit triggers a lubrication pulse. At each lubrication pulse, the electromagnetic pump releases precise lubricant doses - 60 mm<sup>3</sup> /pulse - which are projected toward the lubrication point.

The user sets, from the integrated control unit, the duration of the lubrication cycle. For more information, see section 6.2 Control unit.

### 3.3.2 Capillarity

When the lubricant has reached the lubrication point by projection, it penetrates between the different elements of the chain by capillarity.

A lubricant film is formed at the friction zones. It reduces the temperature rising and therefore the part wear. In addition, it provides extra protection against external pollution, by preventing the foreign matter (dust, particles ...) to penetrate between the different parts.

### Friction zones

The chains have a large number of friction zones that should be lubricated. The example below shows a sectional view of a roller chain with different parts and friction zones.

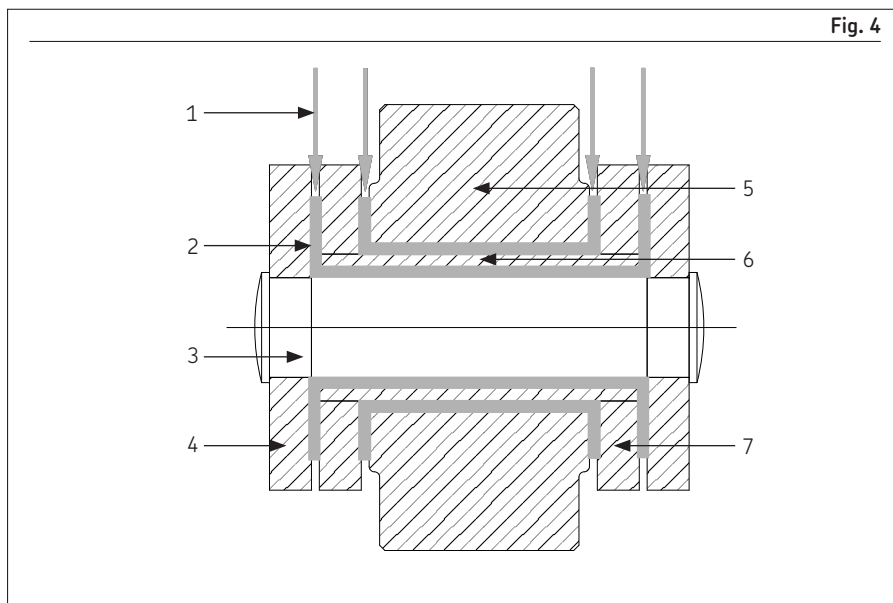

- Friction zone**  
1 Lubricant inlet  
2 Lubricant film  
3 Pin  
4 Outer plate  
5 Roller  
6 Bearing  
7 Inner plate

## 4. Technical data

Table 2

### Technical data

CLK lubrication system

#### Pumping unit

Flow rate	30 or 60 mm <sup>3</sup> / per stroke and outlet according to the model
Lubricant	mineral or synthetic oils without additive or particle
Viscosity	20 to 1 000 mm <sup>2</sup> /s at projection temperature
Delivery pressure	100 bar max.
Working frequency	2 strokes/s max.
Mechanical life	20 × 10 <sup>6</sup> cycles maximum
Operating temperature	60 °C max.
Altitude	< 2,000 m
Reservoir capacity	7,5 l (usable capacity)
Level monitoring	Minimum level check
Material, reservoir	HDPE
Material, housing	ABS
Weight	approx. 12 kg (reservoir full)
Acoustic emission	≤ 70 dB (A)
Protection class	IP 65

Operating voltage	115 or 230 V AC (according to the model)
Frequency	50/60 Hz
Current	5,5 A
Network overvoltage category	2 500 V
Fuse	2,5 A (T2.5AL250V)
Network type	TN
Power supply connector	24 square, female, 3 × 1.5 mm <sup>2</sup>
Inductive proximity sensor connector	DIN43650 type C
Minimum level connector (according to version)	DIN43650 type C
Fault output connector	DIN43650 type A

#### Projection nozzle

Type	squirt nozzle with one or two outlets
Projection	vertical, top-down
Volume	30 mm <sup>3</sup> / stroke and outlet
Projection distance	5 to 50 mm
Lubricant	7 to 220 mm <sup>2</sup> /s at projection temperature
Operating temperature	-25 to +200 °C
Off service temperature	-40 to +200 °C
Lubricant inlet	for metallic tube Ø 4 mm, length 5 m max.
Weight	approx. 50 g
Material	stainless steel 304, FPM seal for check valves
Number of nozzles	2
Accessories	holder and fittings

#### Inductive proximity switch

Sensor type	3-wire DC PNP
Output function	NO
Operating voltage	10 to 36 V DC
Nominal range	5 mm
Operating temperature	-40 to +85 °C

#### Pipe

Length	2.5 or 5 m
Diameter	4 mm thin wall
Material	stainless steel, PTFE pipe holder

\* For other viscosities, take contact with the SKF Service Centre.

# 5. Transport, delivery and storage

## 5.1 Transport

SKF products are packaged in accordance with the regulations of the recipient country and in accordance with DIN ISO 9001. Our products must be transported with care. Products must be protected against mechanical influences such as impacts. Transport packaging must be labeled with the information 'Do not drop!'.

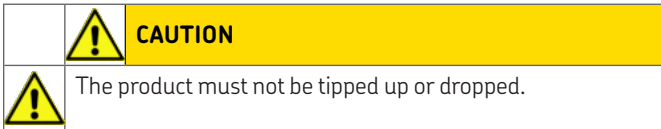

There are no restrictions relating to land, air, or sea transportation.

## 5.2 Delivery

Following receipt of the shipment, the product or products must be checked for damage and the shipping documents should be used to make sure that the delivery is complete. Keep the packaging material until any and all problems have been clarified.

## 5.3 Storage

The following conditions apply to the storage of SKF products.

### 5.3.1 Storage of lubrication units

- Ambient conditions: dry, dust-free environment; storage in well-ventilated, dry area
- Storage time: 24 months max.
- Permitted air humidity: < 65%
- Warehouse temperature: 10 to 40 °C
- Light: direct sunlight/UV radiation must be avoided; nearby sources of heat must be screened



### 5.3.2 Storage of electronic and electrical devices

- Ambient conditions: dry, dust-free environment; storage in well-ventilated, dry area
- Storage time: 24 months max.
- Permitted air humidity: < 65%
- Warehouse temperature: 10 – 40 °C
- Light: direct sunlight/UV radiation must be avoided; nearby sources of heat must be screened

### 5.3.3 Storage – general information

- Ensure that no dust gets into stored products by wrapping them in plastic film
- Store products on racks or pallets to protect them from damp floors
- Before placing products into storage, protect uncoated metal surfaces – and drive parts and mount surfaces in particular – from corrosion using long-term corrosion protection.



# 6. Installation instructions

	 <b>WARNING</b>
	All installation, setting, maintenance and repair works on the lubrication system must be carried out only when the conveyor is off duty. Working closed to a running conveyor chain may cause operator's injuries and/or important material damages.

## 6.1 General

The product described in the mounting instructions may only be installed, operated, maintained, and repaired by qualified experts. Qualified personnel are persons who have been trained, instructed, and familiarized by the user of the end product into which the system is installed. These persons are considered capable of such tasks due to their education, training, and experience with valid standards, conditions, accident prevention regulations in effect, and installation conditions. They should be able to carry out the required tasks and to recognize – and thus avoid – any dangers that might otherwise occur.

Before installing/positioning the product, remove the packaging material and any transportation safety devices such as sealing plugs. Keep packaging material until any possible problems have been clarified.

	 <b>CAUTION</b>
	The lubrication system must not be overturned or discarded.

Country-specific accident prevention regulations and the operating and maintenance instructions for the operator must be observed when carrying out all installation work on machines.



## 6.2 Position



The system must be mounted in a way that protects it from humidity and vibrations. It should also be easily accessible so that all other installation work can be carried out without hindrance. Ensure that there is sufficient circulating air to prevent the system from overheating. For information on the maximum admissible ambient temperature, see the technical data section.

The product should be mounted vertically in accordance with documentation data.

The control panel of the control unit should be easily accessible to allow the user to control the operation of the system and to make various adjustments. The lubricant reservoir should be clearly visible to easily check the lubricant level.

The location of the lubricating system always depends on the machine configuration. However, SKF recommends to follow this instructions:

- The projection nozzles should be placed at the starting point and above the return belt of the conveyor chain
- The line maximum length between the central unit and the projection nozzles should not exceed 5 m.
- The connection maximum length between the central unit and the proximity sensor should not exceed 5 m.

	 <b>CAUTION</b>
	The projection nozzles and the proximity sensor operate in different temperature ranges. It is not therefore necessary to check the ambient temperature and the working temperature of the place where the nozzles and the sensor will be placed.

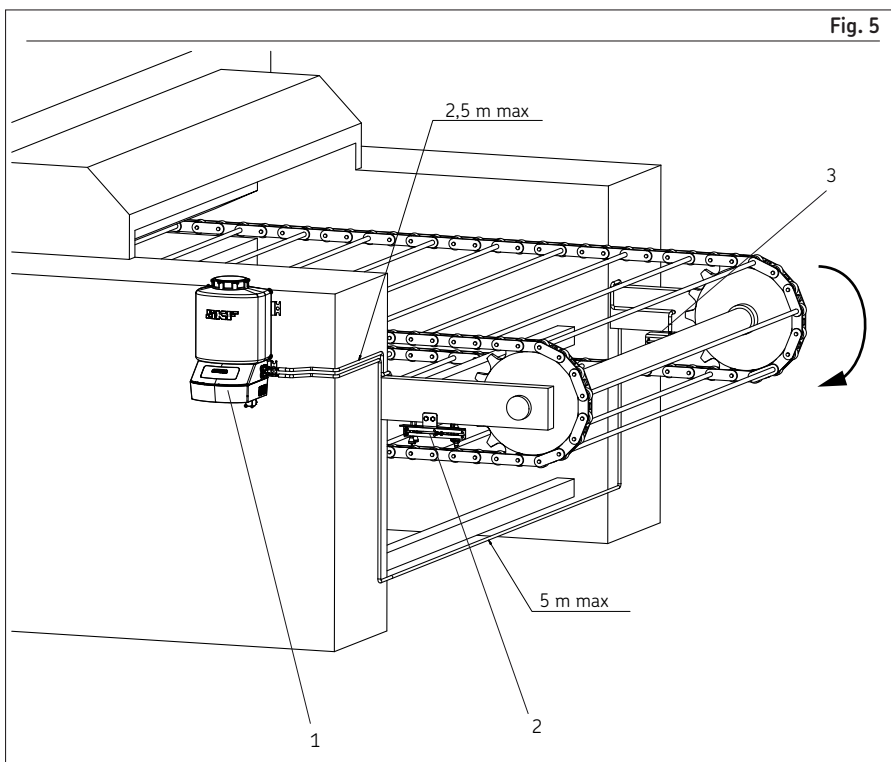

### System installation

- 1 Central unit
- 2 Projection nozzles and proximity sensor
- 3 Projection nozzles

## 6.3 Installation

During installation, and more specifically when holes should be carried out, it is mandatory to observe the following points:

- During installation, do not damage the existing lines.
- During installation, do not damage the other existing groups.
- The central unit should not be mounted in the range of moving parts.
- The central unit should be installed at a sufficient distance from heat sources (→ **Technical data**).
- It is mandatory to observe safety distances, as well as local guidelines on installation and accident prevention.
- Use existing holes if possible.
- Use washers if the holes on the holder are too large.

### 6.3.1 Installing the central unit

The central unit is intended to be mounted on a wall.

The central unit has four mounting plates, two located in the reservoir, and two on the housing (→ **fig. 6**). The mounting plates are intended for M8 × 1.25 Class 8.8 (metal bracket) screws or expansion metal plugs and diameter 8 screws. Mounting is carried out in the space provided for this purpose and with the appropriate mounting material (e.g.. screws, washers, nuts).

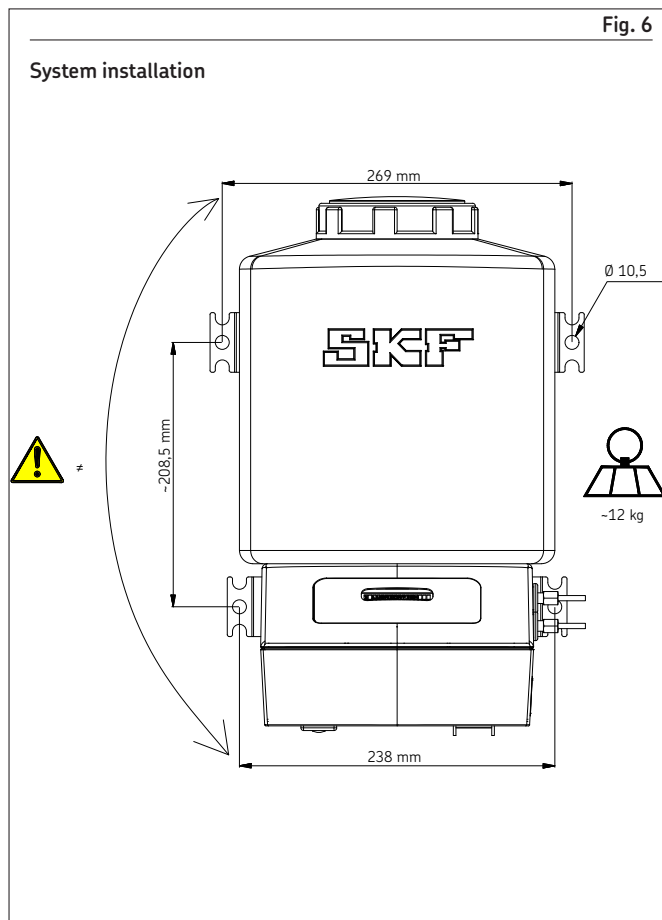

It is important to provide a free space (→ **fig. 7**) around the central unit to allow all installation and maintenance works, as well as the unit filling.



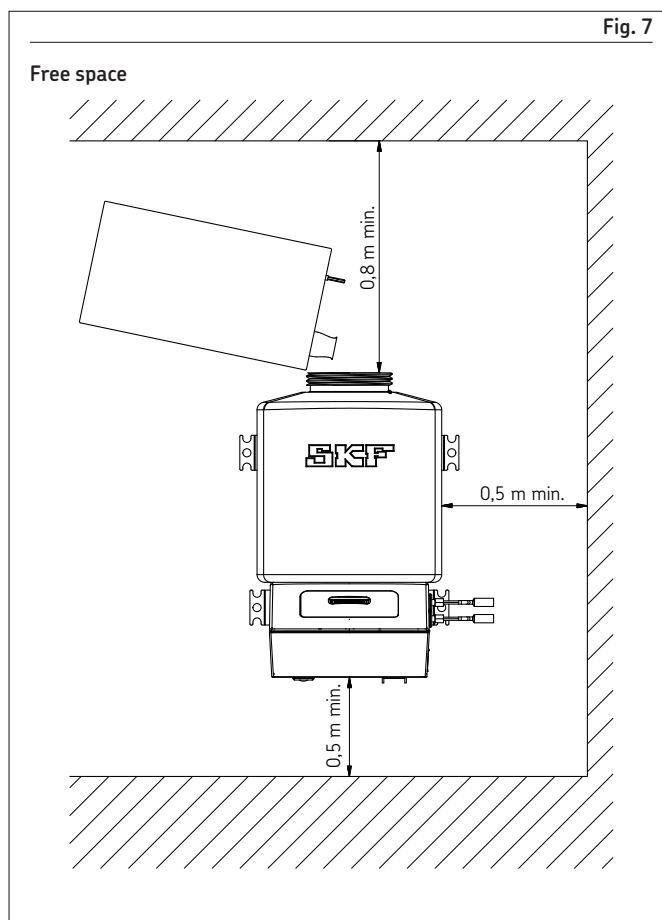

! CAUTION	
!	It is necessary to properly secure the lubrication system on its support to prevent any accidental system fall. A system fall may damage it or cause material damage and can also injure the operator or other people.



## 6.3.2 Nozzle installation

 <b>CAUTION</b>
 Only remove the protections from the projection nozzle heads at the last moment to avoid any damage due to installation work.

The nozzles should be placed directly above the chain rollers, at the starting point of the chain return belt (→ **fig. 5**). The projection head should be placed vertically with respect to the lubrication point - i.e. the friction zone between two roller elements, (→ **fig. 8**). In the case where the two projection heads of the nozzle are not perfectly aligned, it is possible to adjust the gap between them.

 <b>CAUTION</b>
 The projection nozzles should be perfectly vertical to the chain rollers. It is also mandatory to observe the installation distances of the nozzles.

### 6.3.2.1 Nozzle adjustment

The center distance between the two spray heads of a nozzle is min 4.5 mm and max 10 mm. The nozzle heads should be perfectly vertical to the lubrication points (→ **fig. 9**). Depending on the chain roller configuration, you can adjust mechanically the center distance between the nozzle heads by means of a 2,5 mm Allen wrench (→ **fig. 8**).

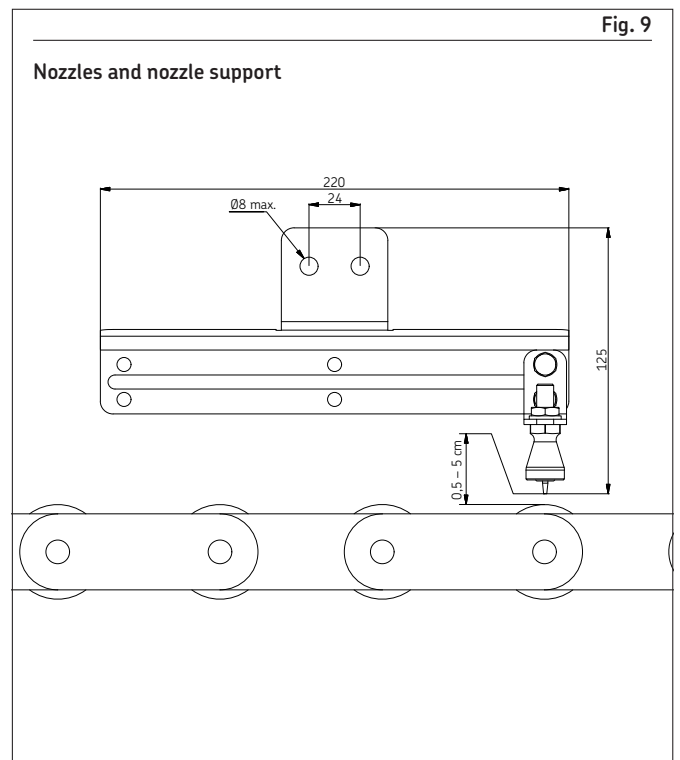
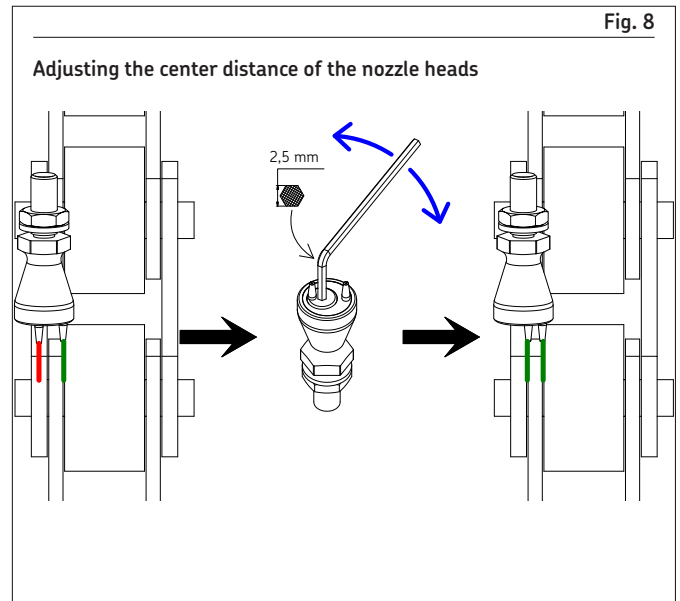

### 6.3.2.2 Nozzle mounting



To mount the projection nozzles, you can use the support provided for this purpose (→ fig. 10). Once the support is mounted, it is only possible to adjust horizontally the projection nozzle position. SKF recommends therefore to simulate the nozzle positioning with respect to the chain before mounting the support.

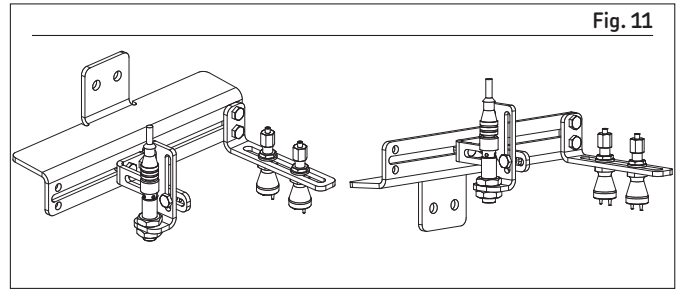

- 1 Install and mount the support. Depending on the chain configuration, the support can be mounted in two different ways (→ fig. 11).
- 2 Place and secure the nozzles bracket (three possible positions) (→ fig. 10). Observe the distances
- 3 Insert the nozzles in the bracket slot from below
- 4 Insert and slightly tighten the washer and the nut
- 5 Adjust the nozzle position by sliding them along the slot
- 6 Tighten the nut



### 6.3.3 Mounting the proximity sensor

The proximity sensor is mounted on the same support as the nozzles. SKF recommends to place the proximity sensor before the projection nozzle relative to the chain travel direction.

	<b>CAUTION</b>
	The chain to be lubricated is moving during the process. It is therefore important to follow the installation distances to avoid any mechanical damage to the projection nozzles.



	<b>CAUTION</b>
	It is necessary to observe the installation distances of the proximity sensor.

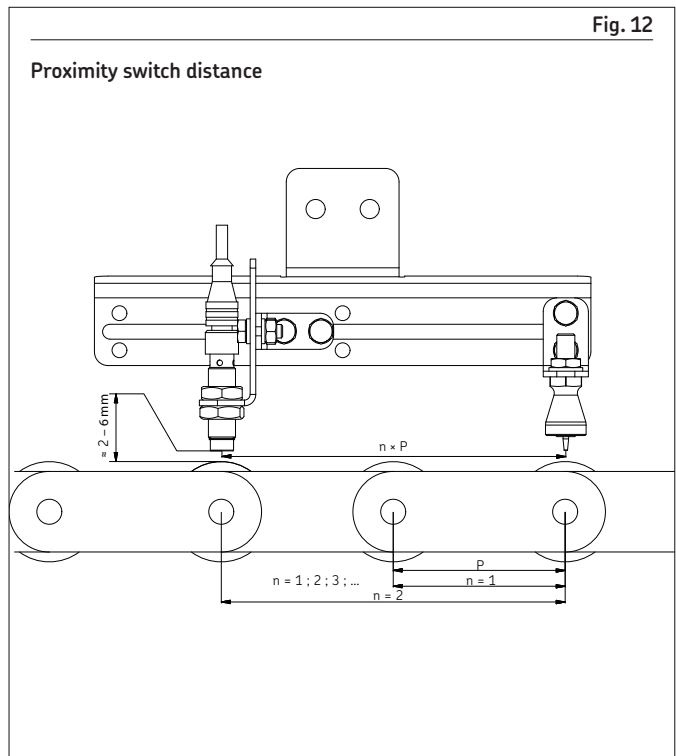
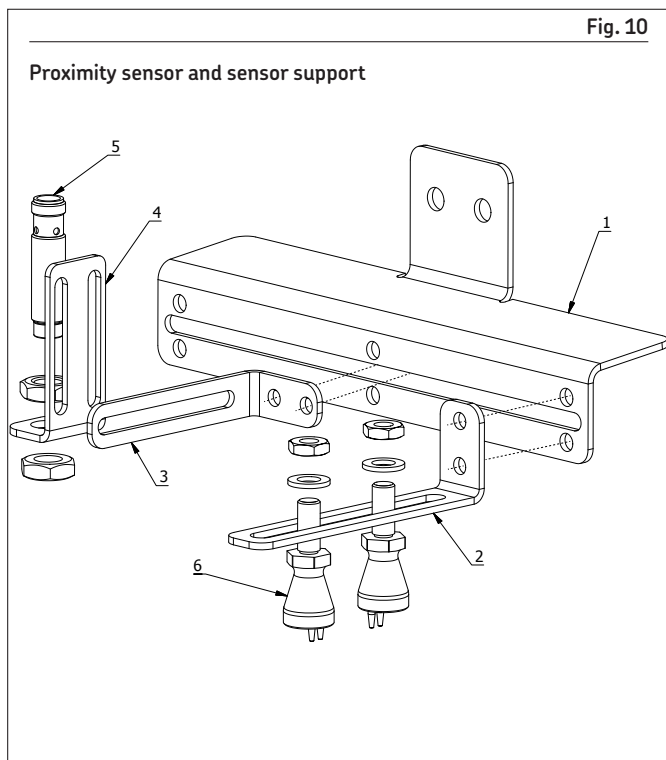

- 1 Mount the sensor on the bracket with the nut and the lock nut
- 2 Mount the bracket on the support
- 3 Adjust the sensor horizontal and vertical position (→ fig. 12). It must be vertical with respect to a lubrication point
- 4 Observe the rated range of the sensor (→ Technical data)



## 6.4 Hydraulic connections

The lubrication line should be connected to the central unit so that no force can be transmitted to the unit once installed (no pressure on the connection).

 <b>CAUTION</b>
 The connectors and accessories used to connect the lubricant line must be compatible with the pump's maximum service pressure.

 <b>CAUTION</b>
 The line maximum length between the central unit and the projection nozzles is 5 m. For a higher length, contact the SKF Service Center.

### 6.4.1 Central unit outputs



The central unit is equipped with two to four lubricant outputs depending on the model. These outputs are located on the housing side. The connection is made by crimp ring fittings for stainless steel pipes with an outer diameter of 4 mm (→ fig. 13).

### 6.4.2 Nozzles

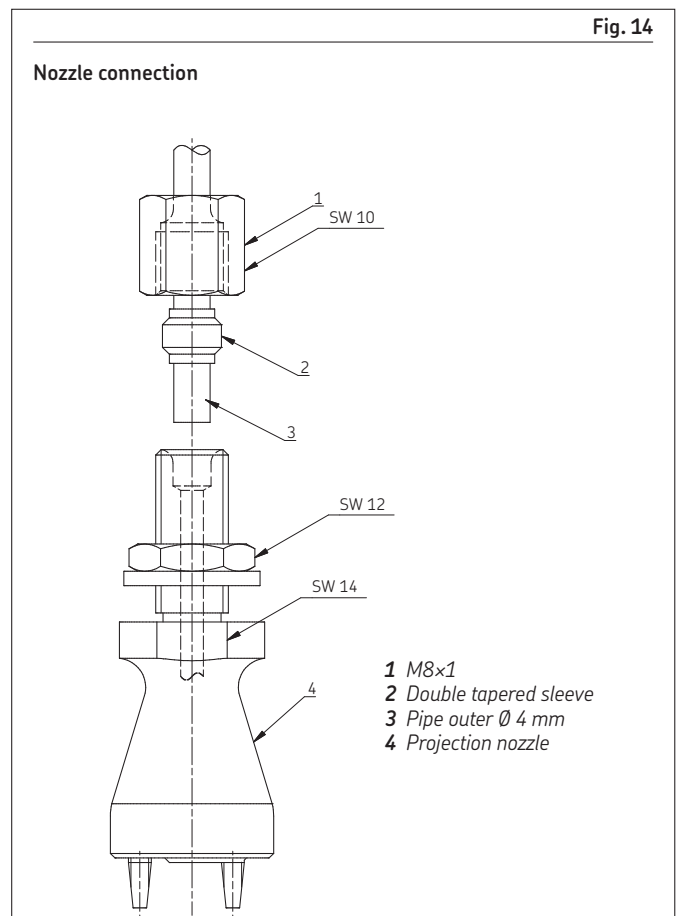
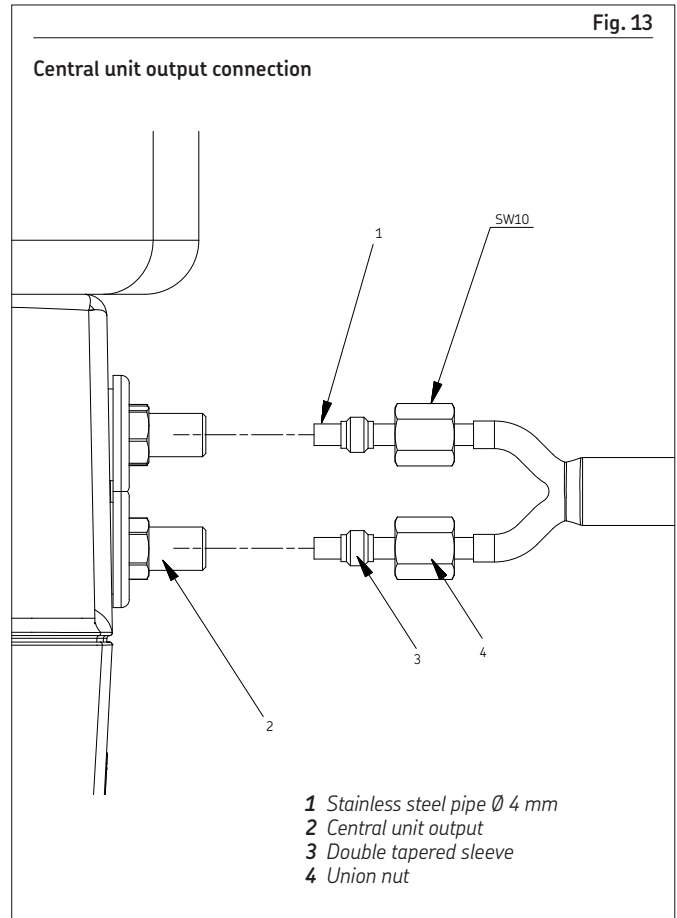
The nozzle connection (→ fig. 14) is made by crimp ring fittings for stainless steel pipes with an outer diameter of 4 mm



## 6.5 Electrical connections

 <b>WARNING</b>
 <p>Only qualified, instructed specialists who are authorized by the operator may install the electrical connections for the lubrication unit. The connection conditions and the local regulations (e.g. DIN, VDE, NF) must be scrupulously respected. If systems are improperly connected, substantial material or personal damage may be the consequence.</p>



The user should carry out three electrical connections to the central unit, namely:

- the power supply connector (→ pos. 4 fig. 15)
- the connector for the proximity sensor (→ pos. 3 fig. 15)
- the connector for the default output (→ pos. 1 fig. 15)
- the fourth connector (→ pos. 2 fig. 15) is optional for external connection of the level-contact

### 6.5.1 Power supply

The power supply of the CLK central unit is 230 V~, 50/60 Hz (voltage key + 428) or 115 V~, 50/60 Hz (voltage key + 429).

For the pin assignment on the power supply connector, see Table 2.

 <b>WARNING</b>
 <p>The supply voltage on site must agree with the information on the codification of the lubrication system. Check the fusing of the circuit. Use only the original fuse with the required ampere value. If other fuses are used, damage to property or personal injury may be the consequence.</p>

### 6.5.2 Fault output

The user can connect the fault output to an external light signal or to its control panel. The user can therefore get more easily the fault information.

For the pin assignment on the fault output connector, see Table 3.

### 6.5.3 Proximity sensor

An inductive proximity sensor is placed at the chain. It detects the passage of the lubrication points. When the system is in lubrication phase, the sensor sends a signal to the control unit each time it detects a lubrication point. The control unit triggers an lubrication pulse.

For the pin assignment on the proximity sensor connector, see Table 4.



Table 3

Power supply connector pins

Pin	Description
1	L – phase
2	N – neutral
GND	GND – grounding

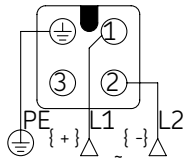

Table 4

Default output connector pins

Pin	Description
1	NO – closing contact
2	NC – opening contact
3	common

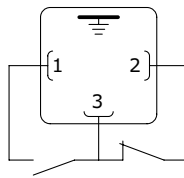
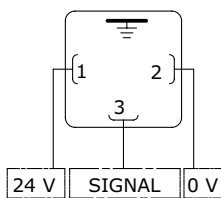

Table 5

Proximity switch connector pins

Pin	Description	Wire color
1	24 V	brown
2	0 V	blue
3	Signal	black







# 7. Commissioning

## 7.1 General

The product described operates automatically. However it is recommended that you regularly verify that the lubricant is correctly transported along the lines.

The level of lubricant in the reservoir, if present, must be checked visually at regular intervals. When the lubricant level is low, fill up with lubricant, as described in chapter Filling with lubricant.

 <b>CAUTION</b>
 Always respect the equipment manufacturer's recommendations concerning which lubricant to use.

 <b>CAUTION</b>
 Only use a clean lubricant. Soiled lubricants can cause major defects in the system. Different lubricants must not be mixed together. Doing so can cause damage and require extensive cleaning of the lubrication system. To prevent any risk of error, it is recommended to clearly identify the lubricant used on the reservoir. Depending on the nature of the lubricant used, the user should wear protective equipment such as glasses, a mask and gloves. For further information please consult the technical file and the safety data sheet for the lubricant used.

## 7.2 Control Unit





The UCDE central unit features an integrated command and control unit. The main function of this unit is to trigger a lubrication pulse upon reception of a signal from the proximity sensor placed on the chain to be lubricated.

### 7.2.1 Interface

The command and control unit features an easy-to-use interface in front of the UCDE unit housing (→ fig. 16).

This interface includes:

- a 2 × 16 digit screen
- four buttons (→ Table 6)
- a LED (default)

Buttons on the control unit	
Button	Description
	Manual start of the lubrication / stop of the lubrication in progress
	Navigation or increment
	Navigation or decrement
	Validation / access to a parameter for modification (press ca. 5 s)



### 7.2.2 Control unit menus

The control unit software has seven main menus. These menus are numbered for easy identification.

- 1 Display: real-time display of the lubrication status
- 2 Lubrication: configuration of lubrication mode (cyclic, semi-automatic or continuous) and cycle time in case of cyclic lubrication (modifiable by the user).
- 3 Number of axes: configuration of number of axes to be lubricated on the chain for each lubrication cycle (changeable by the user)
- 4 Pitch jump: lubrication frequency according to lubrication points
- 5 Pump control: pump control setting



- 6 Fine adjustment: adjustment of the projection position relative to the chain
- 7 Draining: lubrication circuit draining
- 8 Status of inputs and outputs
- 9 Languages: selection of the control unit interface language

determined by the number of axes of the chain (→ § 7.2.3.2), followed by the pause phase. The minimum cycle time is 0 h 01 min, and the maximum cycle time is 999 h 59. The default set value is 0 h 01 min.









To move from one menu to another, press the navigation buttons.

## 7.2.3 Parameters

The control unit allows you to adjust various parameters.

### 7.2.3.1 Lubrication

The lubrication parameter allows to adjust the lubrication system mode: cyclic, semi-automatic or continuous. In case of cyclic lubrication, you should set a time corresponding to the time between two lubrication cycle start-ups. The cycle includes the lubrication phase,

Lubrication, menu 2	
Screen	Description
	<ul style="list-style-type: none"> <li>• Go to menu 2 Lubrication with </li> <li>• Enter the menu by pressing for 5 seconds </li> </ul>
  	<ul style="list-style-type: none"> <li>• Select the lubrication mode with  <ul style="list-style-type: none"> <li>– Continuous*</li> <li>– Semi-automatic*</li> <li>– Cyclic</li> </ul> </li> </ul> <p>If you select cyclic lubrication, it is necessary to set the cycle time with the same keys. The minimum cycle time is 0 h 01 min, and the maximum cycle time is 999 h 59.</p> <p>*) To access the Continuous and Semi-automatic parameters, you have to lower the time to 0 h 01 min</p> <ul style="list-style-type: none"> <li>• Confirm and go back to menu 2 Lubrication by pressing </li> </ul>

#### Lubrication cycle

A lubrication cycle consists of a lubrication phase, during which lubrication points are lubricated, followed by a pause phase. There are two parameters to be set: the duration of the lubrication cycle in time and the number of chain roller to be lubricated during the lubrication phase. The length of the pause phase depends on the total number of lubrication points and the duration of the lubrication cycle.

#### Semi automatic lubrication

The user manually triggers the lubrication phase. This phase corresponds to the number of lubrication points set by the user. Once the last point has been lubricated, the lubrication phase is done and the

system stops. The user can trigger another lubrication phase whenever necessary.







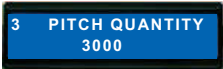

#### Continuous lubrication

All lubrication points are continuously lubricated as long as the chain is running and the lubrication system is powered.

### 7.2.3.2 Number of axes

The pin number parameter allows to set the number of lubrication points to be lubricated during a lubrication cycle. The minimum

number of points is 0, and the maximum number of points is 9,999. The default value is 100.









Number of axes, menu 3	
Screen	Description
	<ul style="list-style-type: none"> <li>Go to menu 3 <i>Number of axes</i> with  </li> <li>Enter the menu by pressing for 5 seconds </li> </ul>
	<ul style="list-style-type: none"> <li>Set the number of axes with  </li> </ul> <p>The minimum number of points is 0, and the maximum number of points is 9,999.</p> <ul style="list-style-type: none"> <li>Confirm and go back to menu 3 <i>Number of axes</i> by pressing </li> </ul>

### 7.2.3.3 Pitch jump

The pitch jump parameter allows to set the lubrication frequency according to the lubrication points. If it is no possible to lubricate all

lubrication points in a row because of the chain speed, it is then possible to lubricate every n points.

The default value of n is 1 (factory setting).

Pitch jump	
Screen	Description
	<ul style="list-style-type: none"> <li>Go to menu 4 <i>Pitch jump</i> with  </li> <li>Enter the menu by pressing for 5 seconds </li> </ul>
	<ul style="list-style-type: none"> <li>Set pitch jump with  </li> <li>Confirm and go back to menu 4 <i>Pitch jump</i> by pressing </li> </ul>

#### NOTE







The total number of lubrication points must not be a multiple of the pitch jump value.  
If you need some held to determine the best pitch jump value for your chain, please contact the SKF Service Center.

### 7.2.3.4 Pump control

Lubrication impulse triggering when the lubrication point is detected.

Lubrication impulse can be triggered straight – DIRECT – when control unit receives the signal from proximity switch (factory setting). This solution suits to chain with constant speed or with frequent stops. With this mode it may be necessary to adjust mechanically the proximity switch or nozzle(s) position to balance the system response time.

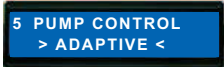
The lubrication impulse triggering can be adjusted automatically – ADAPTIVE – after reception of the proximity switch signal. Reception times of previous proximity switch signals are taken into account. This solution suits to chains with variable speed or with very few stops.







Pump control, menu 5	
Screen	Description
	<ul style="list-style-type: none"> <li>Go to menu 5 <i>Pump control</i> with  </li> <li>Enter the menu by pressing for 5 seconds </li> </ul>
	<ul style="list-style-type: none"> <li>Select control mode with  </li> <li>Confirm and go back to menu 5 <i>Pump control</i> by pressing </li> </ul>

### 7.2.3.5 Fine adjustment – Nozzle position

The user can adjust the position of the nozzles relative to the lubrication points, without mechanical intervention. To do so, the user increases or decreases the lubrication signal advance in order to refine the accuracy of the projection impact.









#### NOTE

This setting is only possible when in the previous menu PUMP CONTROL the parameter ADAPTIVE has been selected. In the contrary, the menu is locked and can not be modified.

Fine adjustment, menu 6	
Screen	Description
	<ul style="list-style-type: none"> <li>Go to menu 6 <i>Fine adjustment</i> with  </li> <li>Enter the menu by pressing for 5 seconds </li> </ul>
	<ul style="list-style-type: none"> <li>Increase or decrease advance of the impact location on chain with  </li> <li>Confirm and go back to menu 6 <i>Fine adjustment</i> by pressing </li> </ul>

### 7.2.3.6 Languages

The user can select the language of the control unit interface. Three languages are available: English, French and German.

Languages, menu 9	
Screen	Description
	<ul style="list-style-type: none"><li>Go to menu 9 <i>Languages</i> with  </li><li>Enter the menu by pressing for 5 seconds </li></ul>
	<ul style="list-style-type: none"><li>Select a language with  </li><li>Confirm and go back to menu 9 <i>Languages</i> by pressing </li></ul>

## 7.3 Bleeding

It is essential to bleed (lubrication line filling) the system before commissioning and after works carried out on the lubrication lines.

You should start bleeding from the control unit. To facilitate bleeding, it is recommended to initially bleed without nozzles.

At the beginning of the bleeding phase, the lubrication system is off

- 1 If the nozzles are already connected to the lubrication system, remove the fittings to separate nozzles from the system
- 2 Switch the central unit on
- 3 Start draining following the procedure described in Table 10
- 4 Once the lubricant comes out from all lines with no air bubbles, stop bleeding
- 5 Turn the system off
- 6 Connect the nozzles to the lines
- 7 Turn the lubrication system on again
- 8 Restart bleeding until the lubricant comes out from all nozzles with no air bubbles

## 7.4 Reservoir filling

- 1 Clean the filling cap before removing it
- 2 Remove the reservoir cap and fill up with an appropriate lubricant.

### NOTE



Lubrication lines do not have the same length. The duration of the bleeding phase can vary. SKF estimates the bleeding lasts ca. 5 min for the 5 m long lubrication line, i.e. 1 m/min average

### Draining, menu 7



Screen

Description

5 BLEEDING  
OK to start

- Go to menu 6 *Draining* with  
- Start draining by pressing for 5 seconds 

5 BLEEDING  
OK = stop

- Stop draining by pressing  

- 3 Put back the reservoir cap.



### CAUTION



Ensure the reservoir is filled with lubricant that does not contain air bubbles.



### CAUTION



Only authorized lubricants for the pump type may be supplied. Unsuitable fluids may cause the unit to fail and lead to serious material damage and bodily injury.



### CAUTION







If the ambient air is polluted, set aside a clean zone to fill the system and thereby prevent foreign bodies from entering. It is also important to clean the reservoir cover or the filler plugs before removing them.

## 7.5. Commissioning

Before activation, check all electrical and hydraulic connections.

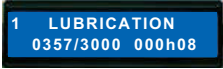

Once the CLK lubrication system is on, the lubrication process starts according to user configuration.



The user can follow the progress of the lubrication process at any time by reading the messages displayed on the central unit (→ Table 7).

Display, menu 1	
Screen	Description
	<ul style="list-style-type: none"> <li>The lubrication system is operating in cyclic mode. Lubrication phase is in progress.               <ul style="list-style-type: none"> <li>– 0357 = number of axes lubricated</li> <li>– 3000 = number of axes to be lubricated</li> <li>– 000h08 = time elapsed since the beginning of the lubrication cycle</li> </ul> </li> </ul>
	<ul style="list-style-type: none"> <li>The lubrication system is operating in cyclic mode. Pause phase is in progress.               <ul style="list-style-type: none"> <li>– 000h00 = pause time elapsed</li> <li>– 000h30 = pause time remaining</li> </ul> </li> </ul>
	<ul style="list-style-type: none"> <li>The lubrication system is operating in semi-automatic mode. Lubrication phase is in progress.               <ul style="list-style-type: none"> <li>– 0003 = number of axes lubricated</li> <li>– 3000 = number of axes to be lubricated</li> </ul> </li> </ul>
	<ul style="list-style-type: none"> <li>The lubrication system is operating in semi-automatic mode. Lubrication phase is completed.               <ul style="list-style-type: none"> <li>– 000h35 = time elapsed since the lubrication of the first axis</li> </ul> </li> </ul>
	<ul style="list-style-type: none"> <li>The lubrication system is operating in continuous mode. Lubrication phase is in progress.               <ul style="list-style-type: none"> <li>– 0006 = number of axes lubricated</li> <li>– 3000 = number of axes to be lubricated (loop counting)</li> </ul> </li> </ul>

# 8 Maintenance

SKF is not liable for damage caused by improper installation, maintenance, or repair work.

 <b>WARNING</b>	
	Working on products that have not been disconnected from the power supply can cause serious injury or death to persons. Installation, maintenance, and repair work may only be carried out by qualified experts on a product that is not connected to a power supply. The supply voltage must be turned off before any product components are opened.

 <b>WARNING</b>	
	The described product may be under pressure when it is being operated. The product must therefore be depressurized before starting installation, maintenance, or repair work and before making any changes to the system.

SKF products are low-maintenance. However, to ensure that they function properly and to avoid risks right from the startup, all joints and connections should be checked to make sure that they are properly fitted.

If necessary, you can clean the pump using gentle, material-appropriate cleaning agents (no alkali, no soap). For safety reasons, the pump must be disconnected from electric supply before cleaning.

During cleaning, it is important to make sure that no cleaning agent enters the inside of the pump.

If the system is operated normally with intercompatible lubricants, the inside of the product does not need to be cleaned.

If you accidentally fill the pump with an incorrect or contaminated lubricant, the inside of the product does have to be cleaned. If this occurs, contact SKF Services for more information on cleaning procedures.

## NOTE

You must not dismantle the product or parts of the product during the warranty period. Doing so invalidates all warranty claims.

All other work relating to installation, maintenance, and repair must only be carried out by SKF Service.

Only original SKF spare parts may be used. It is prohibited for the operator to make alterations to the product or to use non original spare parts and resources.

# 9. Failures



Tables 7 and 8 give an overview of possible malfunctions and their causes. If you are unable to rectify the malfunction, please contact SKF Service Center.

## NOTE

You must not dismantle the product or parts of the product during the warranty period. Doing so invalidates all warranty claims.

All other work relating to installation, maintenance, and repair must only be carried out by SKF Service.

Only original SKF spare parts may be used. It is prohibited for the operator to make alterations to the product or to use non original spare parts and resources.

 <b>WARNING</b>	
	Working on products that have not been disconnected from the power supply can cause serious injury or death to persons. Installation, maintenance, and repair work may only be carried out by qualified experts on products that are not connected to a power supply. The supply voltage must be turned off before any product components are opened.







 <b>WARNING</b>	
	Centralized lubrication systems are under pressure when they are being operated. Centralized lubrication systems must therefore be depressurized before starting installation, maintenance, or repair work and before making any changes to the system.

Table 7

### Failure analysis and remedy

Problem	Possible cause	Solution
	Not enough oil in the reservoir	Fill up the reservoir
	Damaged sensor Disconnected connector Cut or damaged cable Wrong sensor used	Replace the sensor Reconnect the connector Repair or replace the cable Use only SKF-provided sensors
<i>Note: if the proximity switch sends no signal after 5 minutes a failure signal is sent.</i>		
	Lubrication stopped manually	Restart lubrication by pressing 
	Information that the sensor works, but it does not detect any link The sensor is too far from the link Chain stopped or very slow	Adjust sensor position (→ 4.2.3)  The system works but indicates links too seldom detected <i>Note: interval between two signals from proximity switch must be less than 5 minutes.</i>

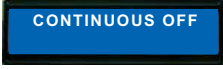

## Failure analysis and remedy

Problem	Possible cause	Solution
<b>The system does not work</b>	Power supply	<ul style="list-style-type: none"> <li>• Check connections and cables</li> <li>• Check that the supply voltage corresponds to the one indicated on the rating plate</li> <li>• Check the connector wiring</li> </ul>
	<b>No lubricant exits the nozzle</b>	<ul style="list-style-type: none"> <li>• Check the lubricant level in the reservoir and top up if necessary.</li> <li>• Check that the lubricant used is compliant with the system technical data. If this is not the case, you should: <ul style="list-style-type: none"> <li>– Drain the lubricant in accordance with the applicable local rules and laws regarding the disposal of lubricant</li> <li>– Thoroughly clean the entire system</li> <li>– Fill up with a suitable lubricant and carry out a new system draining</li> </ul> </li> <li>• Check the condition of the strainer down in the reservoir and clean it if necessary. Before restarting the system, you must perform a new draining.</li> </ul>
	Lack of lubricant	
	Wrong lubricant	
	Reservoir strainer clogged	
	Fittings	<ul style="list-style-type: none"> <li>• Check the fittings on both sides, tighten if necessary</li> </ul>
	Lines	<ul style="list-style-type: none"> <li>• Check the condition of lines (fracture, cut, pinch), and replace them if necessary</li> </ul>
	Clogged nozzle head	<ul style="list-style-type: none"> <li>• Check and clean the nozzle heads</li> </ul>
	Damaged nozzle head	<ul style="list-style-type: none"> <li>• Replace the nozzles</li> </ul>

# 11 Shutdown

## 11.1 Temporary shutdown



You can temporarily shut down the described product by disconnecting the electrical, pneumatic, and/or hydraulic supply connections. For more information, see the section General information in this manual.

If you wish to shut down the product temporarily, refer also to the instructions in the section Transport, delivery, and storage of this manual.

When placing the product back into operation, refer to the information in the sections Installation and Commissioning of this manual.

## 11.2 Permanent shutdown

All country specific legal guidelines and legislation on the disposal of contaminated equipment must be observed when shutting down the product for the final time.

	 <b>CAUTION</b>
	Lubricants can contaminate ground and watercourses. Lubricants must be used and disposed of in compliance with the rules. Instructions and local regulations must be observed when handling lubricants.

The system can also be taken back by SKF for disposal if the costs are covered.

# 12. Spare parts

### NOTE

Only original SKF spare parts may be used. It is prohibited for the operator to make alterations to the product or to use non original spare parts and resources.

Table 9

## Spare parts for kit CLK-460R-100

Order No.	Designation	Comments
UCDE01-460RT	Central unit	give the voltage key when ordering (→ table 1)
AC-A-420	Double nozzle with adjustable interaxial distance	
AC-5121	Proximity switch – Ø12	-40 to +85 °C (standard)
AC.4026.10	Power supply connection kit	
AC.2218	Fault output connector	
AC-4388	Connector proximity switch input	
UCDE01-TU0250	Kit stainless steel tube 316L length 2.5 m	
UCDE01-TU0500	Kit stainless steel tube 316L length 5 m	
SY-9736	Fixing clips for tube Ø12 (min. qty 5)	
BI.410	Double tapered sleeve for tube Ø4	only with RB.409.I
RB.409.I	Nut for tube Ø4	only with RB.410
SY-9729	Support plate	
SY-9730	Nozzle bracket support	
SY-9732	Intermediate support for proximity switch	
SY-9733	Proximity switch bracket support Ø12 and Ø8	
TK-1317	Reservoir plug	

Table 10

## Spare parts for kit CLK-260R-100

Order No.	Designation	Comments
UCDE01-260RT	Central unit	give the voltage key when ordering (→ table 1)
AC-A-420	Double nozzle with adjustable interaxial distance	
AC-5121	Proximity switch – Ø12	-40 to +85 °C (standard)
AC.4026.10	Power supply connection kit	
AC.2218	Fault output connector	
AC-4388	Connector proximity switch input	
UCDE01-TU0500	Kit stainless steel tube 316L length 5 m	
SY-9736	Fixing clips for tube Ø12 (min. qty 5)	
BI.410	Double tapered sleeve for tube Ø4	only with RB.409.I
RB.409.I	Nut for tube Ø4	only with RB.410
SY-9729	Support plate	
SY-9730	Nozzle bracket support	
SY-9732	Intermediate support for proximity switch	
SY-9733	Proximity switch bracket support Ø12 and Ø8	
SY-9732	Intermediate support for proximity switch	
SY-9733	Proximity switch bracket support Ø12 and Ø8	
TK-1317	Reservoir plug	

Table 11

## Spare parts for kit CLK-460R-110

Order No.	Designation	Comments
UCDE01-460RT	Central unit	give the voltage key when ordering (→ table 1)
AC-A-420	Double nozzle with adjustable interaxial distance	
UCDE01-100-HT	Proximity switch – Ø18	-25 to +180 °C (high temperature)
AC.4026.10	Power supply connection kit	
AC.2218	Fault output connector	
AC-4388	Connector proximity switch input	
UCDE01-TU0250	Kit stainless steel tube 316L length 2.5 m	
UCDE01-TU0500	Kit stainless steel tube 316L length 5 m	
SY-9736	Fixing clips for tube Ø12 (min. qty 5)	
BI.410	Double tapered sleeve for tube Ø4	only with RB.409.I
RB.409.I	Nut for tube Ø4	only with RB.410
SY-9729	Support plate	
SY-9730	Nozzle bracket support	
SY-9732	Intermediate support for proximity switch	
SY-9733-1	Proximity switch bracket support	
TK-1317	Reservoir plug	

Table 12

## Spare parts for kit CLK-430R-101

Order No.	Designation	Comments
UCDE01-430RT	Central unit	give the voltage key when ordering (→ table 1)
AC-A-410	Simple nozzle	
AC-5121	Proximity switch – Ø12	-40 to +85 °C (standard)
AC.4026.10	Power supply connection kit	
AC.2218	Fault output connector	
AC-4388	Connector proximity switch input	
UCDE01-TU0250	Kit stainless steel tube 316L length 2.5 m	
UCDE01-TU0500	Kit stainless steel tube 316L length 5 m	
SY-9736	Fixing clips for tube Ø12 (min. qty 5)	
BI.410	Double tapered sleeve for tube Ø4	only with RB.409.I
RB.409.I	Nut for tube Ø4	only with RB.410
SY-9729	Support plate	
SY-9730	Nozzle bracket support	
SY-9732	Intermediate support for proximity switch	
SY-9733	Proximity switch bracket support Ø12 and Ø8	
TK-1317	Reservoir plug	

Table 13

## Spare parts for kit CLK-430R-121

Order No.	Designation	Comments
UCDE01-430RT	Central unit	give the voltage key when ordering (→ table 1)
AC-A-410	Simple nozzle	
AC-5145	Proximity switch – Ø8	-40 to +85 °C (standard)
AC.4026.10	Power supply connection kit	
AC.2218	Fault output connector	
AC-4388	Connector proximity switch input	
UCDE01-TU0250	Kit stainless steel tube 316L length 2.5 m	
UCDE01-TU0500	Kit stainless steel tube 316L length 5 m	
SY-9736	Fixing clips for tube Ø12 (min. qty 5)	
BI.410	Double tapered sleeve for tube Ø4	only with RB.409.I
RB.409.I	Nut for tube Ø4	only with RB.410
SY-9729	Support plate	
SY-9730	Nozzle bracket support	
SY-9732	Intermediate support for proximity switch	
SY-9733	Proximity switch bracket support Ø12 and Ø8	
TK-1317	Reservoir plug	

Table 14

## List of accessories for CLK kits

Order No.	Designation	Comments
UCDE01-100-HTD30	Proximity switch – Ø30	0 to 180 °C (high temperature)
AC-5145	Proximity switch – Ø8	-25 to +70 °C (small chain)
UCDE01-TU0250-AC	Kit steel tube length 2.5 m	
UCDE01-TU0500-AC	Kit steel tube length 5 m	
TU-3X4-IX	Stainless steel tube 316L Ø4x0,5 (per meter)	
WV-R04X0.7VERZI	Steel tube Ø4x0,7 (4 m bar)	
UC-1060-22-1	Proximity switch support, Ø30	Separated mounting from the SY-9729
UCDE01-CT-3-16	Tube cutter 3-16 mm	



**!** **Important information on product usage**  
SKF and Lincoln lubrication systems or their components are not approved for use with gases, liquefied gases, pressurized gases in solution and fluids with a vapor pressure exceeding normal atmospheric pressure (1 013 mbar) by more than 0,5 bar at their maximum permissible temperature.

[skf.com](https://skf.com) | [skf.com/lubrication](https://skf.com/lubrication)

© SKF is a registered trademark of the SKF Group.

© SKF Group 2020  
The contents of this publication are subject to the publisher's copyright and their reproduction, even partial, is prohibited without prior written permission. The greatest care has been taken to ensure accuracy of the information contained in this publication, however, SKF declines any responsibility for any losses or damages, direct or indirect, arising from the use of the information contained herein.

PUB 951-130-452-EN · January 2020