

Product series LP2 and LPC

Lubrication pinions to lubricate open gear wheels and gear racks

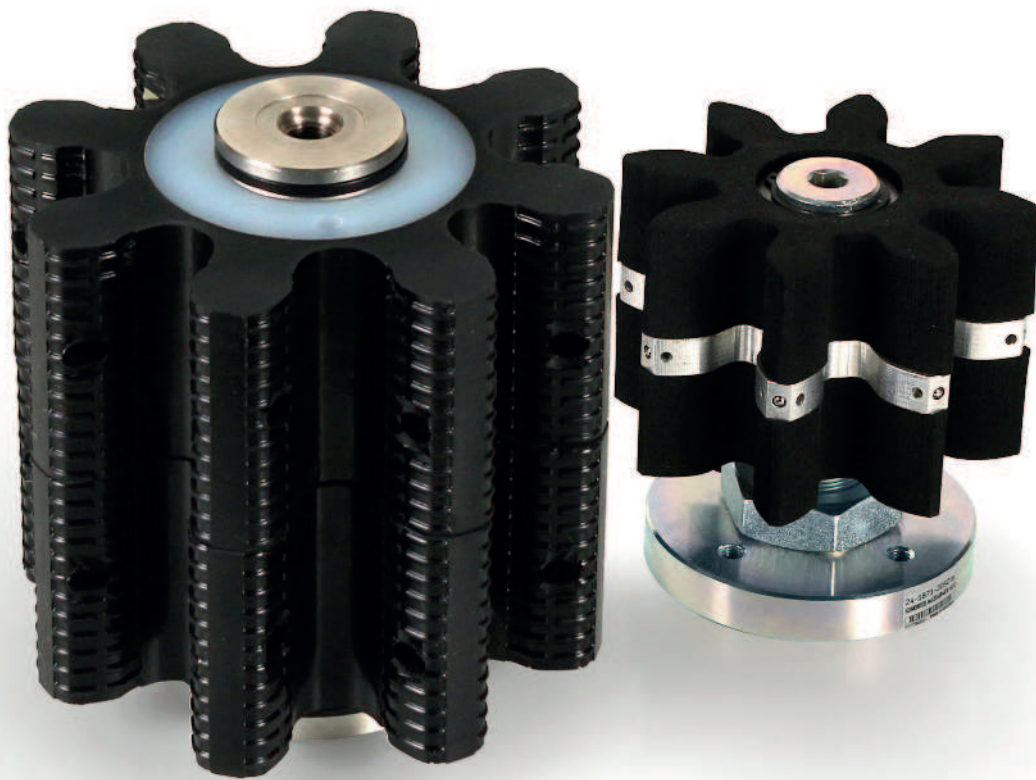

SKF lubrication pinions provide contact lubrication of pinion gears on open gear wheels and gear racks. A lubrication pinion also lubricates the tooth flanks of open gears, such as large slewing bearings or pitch bearings.

The rolling motion of this device continuously applies 100% lubricant film coverage to the tooth flank, thus reducing wear and simultaneously providing corrosion protection to the gear drive.

Connectable to an automatic lubrication system, like pump-to-point, multi-line or progressive, the pinion provides the tooth flanks with the appropriate amount of lubricant.

SKF offers a complete range of variable components, from a standardized series program made of polyurethane (LP2) to a customized single item made of metal (LPC).

The lubrication pinions do not require pressurized air. Therefore, no spray mist contaminates the environment. In addition, NLGI grade 2 grease can be applied. When compared to manual lubrication, use of these pinions provides better quality lubrication, as well as reduces labor and the risk of accidents.

Lubrication pinion LP2

SKF's standard in lubrication pinions, the LP2 is manufactured from a sturdy, wear-resistant, polyurethane material. These pinions are available in seven different module sizes with various widths and inlet fittings, as well as in corrosion classes C3-H or C5-M-H.

Wide range of applications

Its features make the LP2 the preferred lubrication pinion for applications where reliable lubrication is required.

- Azimuth and pitch bearings in wind turbines
- Bucket wheel excavators in the mining industry
- Cranes in ports or on vessels

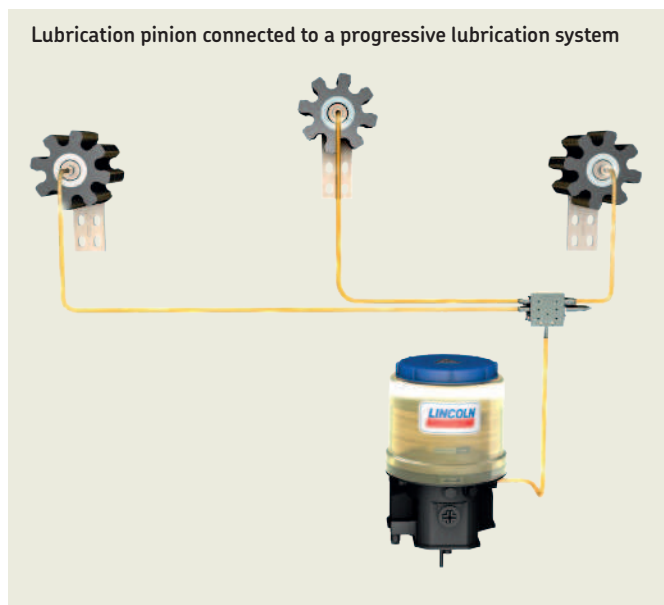

Modular design

The LP2 features a modular system that consists of segments with and without lubricant outlets with a maximum of four segments used per pinion. The different segment widths enable use on module widths from 80 to 240 mm.

The LP2 is suitable for modules 12, 14, 16, 18, 20, 22 and 24.

The segment layout also enables optimum lubrication in applications where the drive pinion is in a tangential deviation.

The LP2 features a modular system

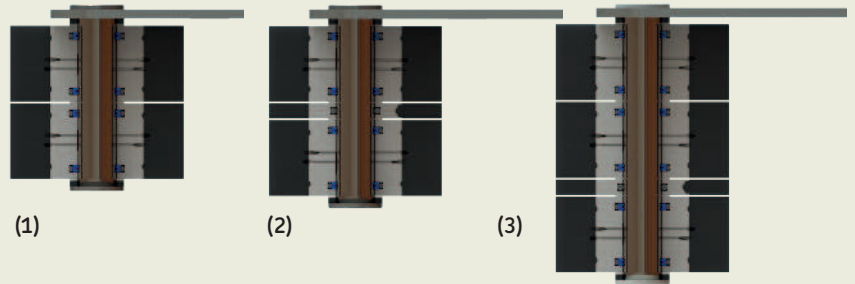

- 1 Pinion with minimum two segments, both with lubricant outlet
- 2 Pinion with one additional segment without lubricant outlet
- 3 Maximum 4 segments per pinion

Lubrication where needed

The geometry of the pinion tooth is optimized in such a way that the LP2 pinion lubricates only where necessary (tooth flanks).

Optimized tooth design, lubrication pocket and comb structure



Optimum lubrication when the drive pinion is in a tangential deviation



Reliable lubricant supply

Each segment of the pinion has its own lubricant channel. The geometry of these channels allows a higher lubricant pressure and helps to ensure that the lubricant is transported reliably to the tooth flank. A "lubrication pocket" and the comb structure of the surface act as lubricant storage, enabling good, dry-running characteristics.

One lubrication channel per segment

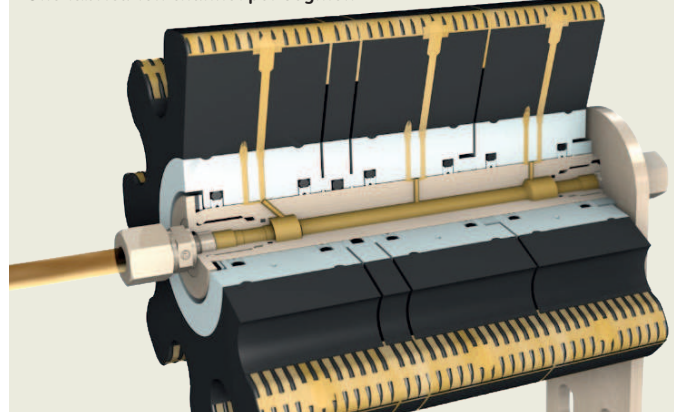

Higher rotational speed

The bushing is designed as a plain bearing that allows a higher rotational speed of up to 80 r/min. This is important for applications where the lubricated slewing bearing moves very fast.



Technical data and spare parts LP2

Technical data

Material	Polyurethane (PU)
Admissible material pairing of LP2 and the component to be lubricated	PU / metal
Number of teeth	8
Modules	12, 14, 16, 18, 20, 22, 24
Lubricants	Greases up to NLGI 2 ¹⁾
Max. admissible volume flow	2,0 l/min ²⁾
Lubricant inlet connection	G ¹ / ₈
Operating temperature	-30 to +70 °C
Rotating direction	any
Mounting position	any
Max. speed	80 r/min
Deviation of the alignment of the axis of the lubrication pinion and the component to be lubricated	± 1°
Maximum eccentricity of the component to be lubricated	1 mm
Active lubricant duct	in direction of arrow (indicated on the bracket)
Long-term usage / interval usage	yes / yes
Durability	min. 1 million revolutions

- 1 Select a lubricant that has no tendency to be thrown out at the expected speed and temperatures.
- 2 In case of compliance with the maximum admissible volume flow no inadmissibly high pressures will be generated in the lubrication pinion.

Spare parts

	Ø	Corrosion class	Part number
Screw plug		C3-H	2260-0000020
Screw plug		C5-M-H	226-14160-3
Screw-in connector	6	C3-H	471-006-192
Screw-in connector	6	C5-M-H	223-13658-2
Push-in connector	6	C3-H	456-004-VS
Push-in connector	6	C5-M-H	226-14111-1
Push-in connector 90°	6	C3-H	506-108-VS
Push-in connector 90°	6	C5-M-H	226-13756-9
Screw-in connector	8	C3-H	223-10814-2
Screw-in connector	8	C5-M-H	408-423W-S3
Screw-in connector	10	C3-H	223-13621-9
Screw-in connector	10	C5-M-H	223-13658-8
Adapter	G 1/4	C3-H	2230-00000032
Adapter	G 1/4	C5-M-H	2230-00000033
Adapter	G 3/8	C3-H	2230-00000034
Adapter	G 3/8	C5-M-H	2230-00000035

Order example

LP2-32-10-DD1

- Lubrication pinion 2
- Corrosion class C3-H
- Module 12
- Pinion width 100 mm
- Inlet on bracket: Screw-in connector Ø8 mm
- Inlet opposite bracket: Screw-in connector Ø8 mm
- With standard bracket

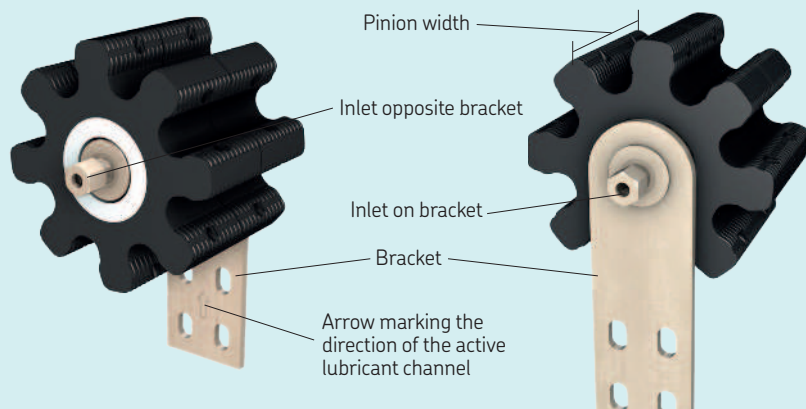

How to order LP2

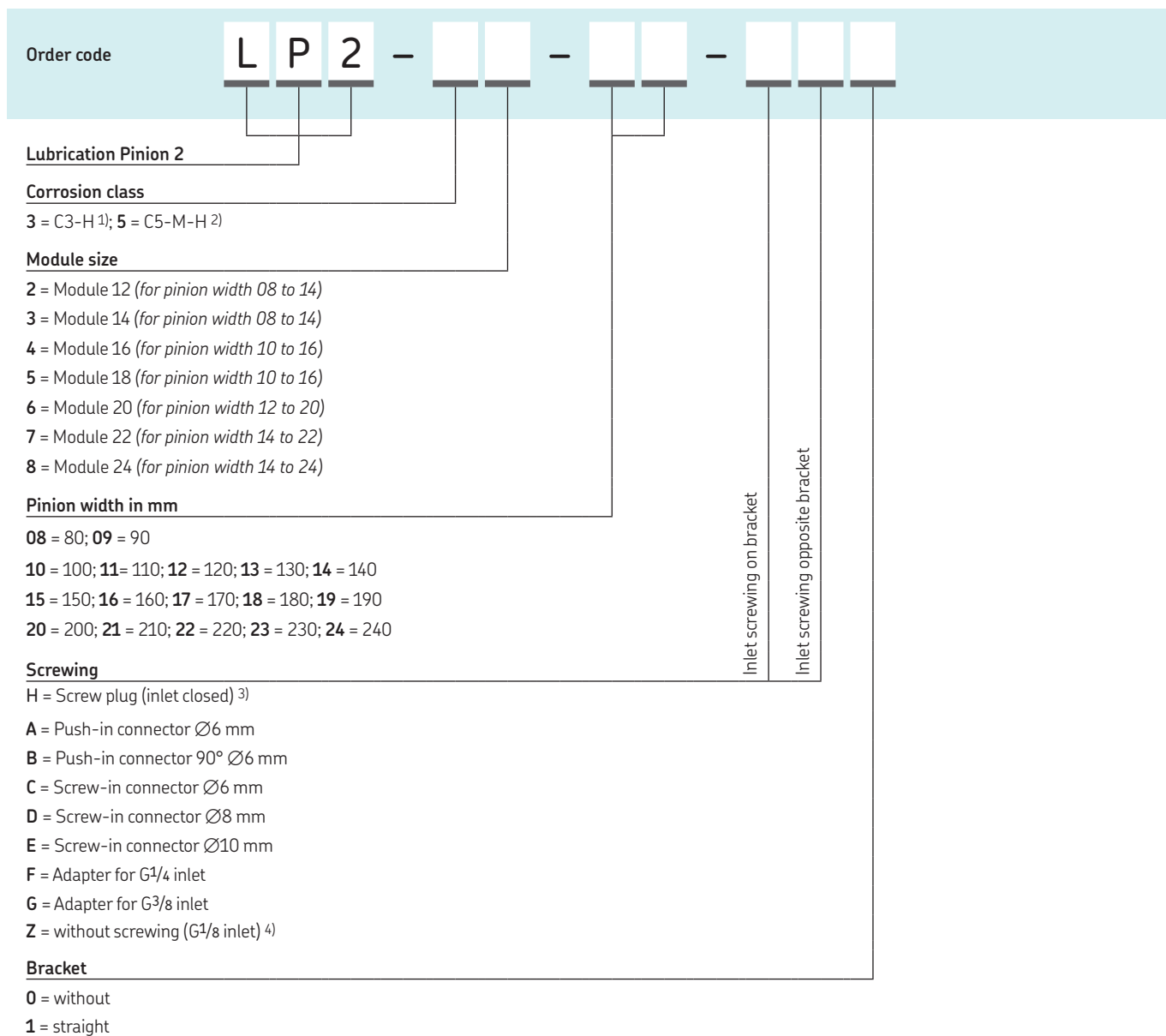

1) C3-H (moderate) Urban and industrial atmospheres, moderate sulphur dioxide levels, production areas with high humidity
 2) C5-M-H (very high) Marine, offshore, estuaries, coastal areas with high salinity
 3) Never close both inlets, only one inlet should be closed
 4) If no screwing is chosen (Z) the corrosion class of the lubrication pinion is C5-M-H, screwing to connect the lubrication pinion has to be added by the customer

LPC

Customized lubrication pinions for non-standard applications

LPC with flange bracket

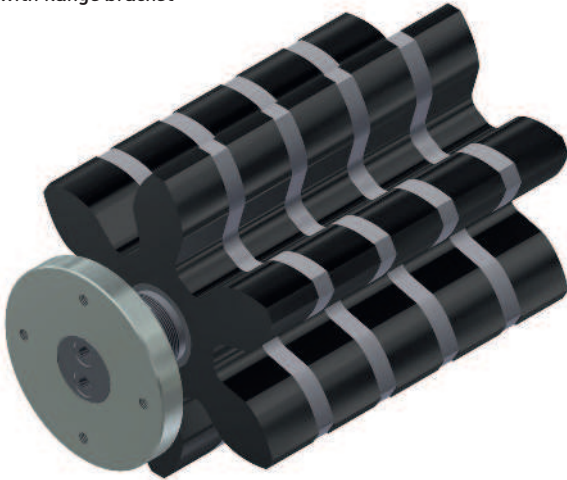

LPC with U-version bracket



The LPC is the customized SKF solution for every need within the metric system that cannot be solved by the standard program. These lubrication pinions are made of metal gear wheels and foam rubber layers. The foam rubber layers ensure that the lubricant is evenly distributed across the entire width of the tooth. The metal gear wheels are resistant to wear and all lubricants and environmental influences.

For any requests, please contact your local sales partner.

Benefits:

With this tailor-made solution very small lubrication pinions (module 3) as well as larger versions can be offered. Also very high rotational speeds are possible by using special bearings. The lubricant channels are inside the metal part of the pinion and ensure a reliable lubricant distribution.

How to find the right module size and to check the maximum speed

Definition and explanation		Standard unit
Z1	Lubrication pinion	
Z2	Wheel to be lubricated	
m	Module	mm
Z	Number of teeth	
d	Pitch diameter	mm
w	Width to be lubricated	mm
ω	Max. rotational speed	r/min

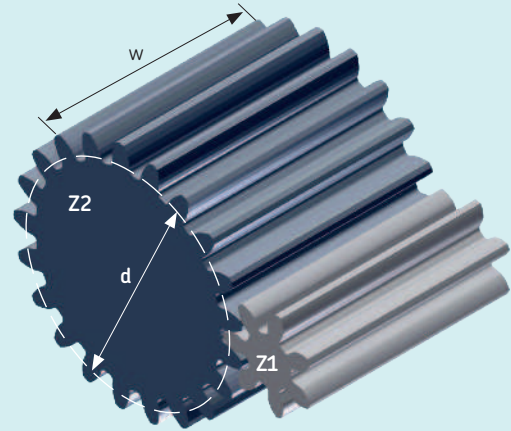

Calculation of the right module size:

The module size of the gear wheel that has to be lubricated and the module size of the lubrication pinion have to be the same.

Example

$$d = 252 \text{ mm}; Z_2 = 21$$

$$m = d/z$$

$$m = 252/21 = 12 \text{ mm}$$

✓ A lubrication pinion with module size 12 mm must be selected.

Calculation of the maximum speed of the lubrication pinion:

Using the max. speed of the wheel that has to be lubricated you can check if the rotation speed of the lubrication pinion is within the allowed range.

Example

$$Z_{Z1} = 7; Z_{Z2} = 21; \omega_{Z2} = 2 \text{ r/min}$$

$$\omega_{Z1} = (Z_{Z2} / Z_{Z1}) \times \omega_{Z2}$$

$$\omega_{Z1} = (21/7) \times 2 \text{ r/min} = 6 \text{ r/min}$$

✓ In this example the max. rotational speed of the lubrication pinion is in the admissible range.



skf.com | skf.com/LP2 | lincolnindustrial.com

® SKF and Lincoln are registered trademarks of the SKF Group.

© SKF Group 2019

The contents of this publication are the copyright of the publisher and may not be reproduced (even extracts) unless prior written permission is granted. Every care has been taken to ensure the accuracy of the information contained in this publication but no liability can be accepted for any loss or damage whether direct, indirect or consequential arising out of the use of the information contained herein.

PUB LS/P2 17779 EN · September 2019

Certain image(s) used under license from Shutterstock.com.