

Curve Sensor Control Unit of the LCG2-A04, LCG2-A07 and LCG2-A08 series

For the control of centralized lubrication systems in railway applications

Operating instructions

EN



Version 05



Note

The devices:
LCG2-A04-xxx+924
LCG2-A07-xxx+924
LCG2-A08-xxx+924 are identical in terms of structure and functions.
They differ only in having different interval times between successive lubrication pulses (-see Table B) and in the function of push-button DK on the LCG2-A08 (see Table 7).
For the sake of simplicity, the following text refers only to “LCG2-A04, LCG2-A07, LCG2-A08” or the “product.”

Masthead

These operating instructions pursuant to EC Machinery Directive 2006/42/EC are an integral part of the described product and must be kept for future use.

These operating instructions were compiled in accordance with the established standards and rules for technical documentation, VDI 4500 and EN 292.

© SKF Lubrication Systems Germany GmbH

This documentation is protected by copyright. SKF Lubrication Systems Germany GmbH reserves all rights, including those to the photo-mechanical reproduction, duplication, and distribution by means of special procedures (e.g., data processing, data media, and data networks) of this documentation in whole or in part.

Subject to changes in contents and technical information.

Service

If you have technical questions, please contact the following addresses:

SKF Lubrication Systems Germany GmbH

Berlin Plant

Motzener Strasse 35/37

12277 Berlin

Germany

Tel. +49 (0)30 72002-0

Fax +49 (0)30 72002-111

www.skf.com/lubrication

Hockenheim Plant

2. Industriestrasse 4

68766 Hockenheim

Germany

Tel. +49 (0)62 05 27-0

Fax +49 (0)62 05 27-101

www.skf.com/lubrication

Table of contents

Curve Sensor Control Unit	1	4.3.2 Function	14	6. Operation	46
Information concerning Declaration of Conformity	4	4.3.3 Lubrication enable	15	6.1 Adjustment elements of the LCG2-A04, LCG2-A07 and LCG2-A08 curve sensor control unit	46
Explanation of safety and informational symbols and safety signal words	5	4.3.4 Functional diagrams	15	6.2 Operating modes of the LCG2-A04/ LCG2-A07 and LCG2-A08 curve sensor control unit	48
1. Safety instructions	6	4.4 Time- or distance-dependent lubrication	19	6.2.1 Curve sensor sensitivity	48
1.1 Intended use	6	4.5 Time-dependent lubrication	19	6.2.2 Curve-dependent lubrication	48
1.2 Authorized personnel	7	4.5.1 Preselection	19	6.2.3 Time-dependent lubrication	50
1.3 Electric shock hazard	7	4.5.2 Function	19	6.2.4 Time- and curve-dependent lubrication	52
1.4 System pressure hazard	7	4.5.3 Lubrication enable	20	6.2.5 Distance-dependent lubrication	54
2. Transport, delivery, and storage	8	4.5.4 Functional diagrams	21	6.2.6 Distance- and curve-dependent lubrication	56
2.1 General	8	4.6 Distance-dependent lubrication	25	7. Commissioning	58
2.2 Electronic and electrical devices	8	4.6.1 Preselection	25	7.1 Commissioning procedure	58
2.3 General notes	8	4.6.2 Function	25	8. Shutdown and disposal	58
3. Overview	9	4.6.3 Lubrication enable	25	8.1 Temporary shutdown	58
3.1 Usage	9	4.6.4 Determining the preset value for distance	26	8.2 Permanent shutdown	58
3.2 Design	9	4.6.5 Functional diagrams	27	9. Maintenance and service	59
3.3 Mounting position and information on electrical installation	9	4.7 Functions of pushbutton DK	34	10. Operational malfunctions	60
3.4 Feeding and application of lubricant (standard lubrication system)	10	4.7.1 Functional diagrams of the pushbutton	34	10.1 General	60
4. Design and function	12	4.8 Setting the lubrication interval time tp	37	10.2 Troubleshooting	60
4.1 Configuration of the LCG2-A04, LCG2-A07 and LCG2-A08	12	5. Assembly	38	11. Technical data	64
4.2 Function	12	5.1 General information	38	11.1 General characteristics	64
4.2.1 Lubricant pump function	14	5.2 Setup and attachment	38	11.2 Electrical characteristics	66
4.3 Curve-dependent lubrication	14	5.3 Assembly of the LCG2-A04/LCG2-A07/ LCG2-A08 curve sensor control unit	40		
4.3.1 Preselection	14	5.3.1 Mounting equipment	40		
		5.3.2 Mounting diagram for LCG2-A04, LCG2-A07 and LCG2-A08	41		
		5.4 Electrical connection	41		
		5.4.1 Electrical connection	42		
		5.4.2 Customer connection	44		

Information concerning Declaration of Conformity

The “curve sensor control unit” products

LCG2-A04

LCG2-A07

LCG2-A08

are hereby confirmed to comply with the requirements of the following standard:

DIN EN 50155:2008-03

Railway applications - Electronic equipment used on rolling stock

See the appendix to the Declaration of Conformity for the operating conditions under which the product complies with the standard DIN EN 50155:2008-03.

Note:

- (a) This declaration certifies compliance with the aforementioned standards, but does not constitute a guarantee of characteristics.
- (b) The safety instructions in the documentation included with the product must be observed.
- (c) The commissioning of the products here certified is prohibited until the machine, vehicle, or similar in which the product is

installed conforms with the provisions and requirements of the applicable Directives.

- (d) The operation of the products at non-standard supply voltage, as well as non-adherence to the installation instructions, can negatively impact the EMC characteristics and electrical safety.

We further declare:

- The aforementioned product is, **according to EC Machinery Directive 2006/42/EC, Annex II Part B, designed for installation in machinery / for incorporation with other machinery to form a machine.** Within the scope of the EC Directive, commissioning shall be prohibited until the machinery in which this product is installed conforms with the provisions of this Directive.
- The aforementioned product may, with reference to **EC Directive 97/23/EC concerning pressure equipment**, only be used in accordance with its intended use and in conformity with the instructions provided in the documentation. The following must be observed in this regard:

The product is neither designed nor approved for use in conjunction with fluids of Group 1 (Dangerous Fluids) as defined in Article 2, Para. 2 of Directive 67/548/EEC of June 27, 1967. The product is neither designed nor approved for use in conjunction with gases, liquefied gases, pressurized gases in solution, vapors, or such fluids whose vapor pressure exceeds normal atmospheric pressure (1013 mbar) by more than 0.5 bar at their maximum permissible temperature.

When used in conformity with their intended use, the products supplied by SKF Lubrication Systems Germany GmbH do not reach the limit values listed in Article 3, Para. 1, Clauses 1.1 to 1.3 and Para. 2 of Directive 97/23/EC. They are therefore not subject to the requirements of Annex 1 of the Directive.

Consequently, they do not bear a CE marking in respect of Directive 97/23/EC. SKF Lubrication Systems Germany GmbH classifies them according to Article 3, Para. 3 of the Directive.

The Declaration of Conformity forms part of the product documentation and is supplied together with the product.

Explanation of safety and informational symbols and safety signal words

You will find these symbols, which warn of specific dangers to persons, material assets, or the environment, next to all safety instructions in these operating instructions.

Please heed these instructions and proceed with special care in such cases. Please forward all safety instructions to other users.

Instructions placed directly on the machine/grease lubrication pump unit, such as:

- Rotation arrows
 - Fluid connection labels
- must be followed and kept in fully legible condition.



You are responsible!

Please read the assembly and operating instructions thoroughly and follow the safety instructions.

Hazard symbols

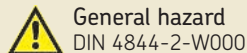

General hazard
DIN 4844-2-W000

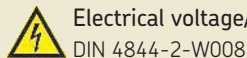

Electrical voltage/current
DIN 4844-2-W008

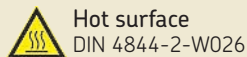

Hot surface
DIN 4844-2-W026

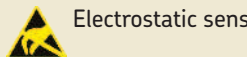

Electrostatic sensitive components

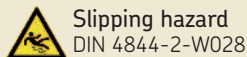

Slipping hazard
DIN 4844-2-W028

Safety signal words and their meaning

Signal word	Meaning
Danger!	Risk of serious injury or death
Warning!	Risk of damage to property and the environment
Note!	Provides additional information

Informational symbols



Note

- Prompts an action

- Used for itemizing

- ➔ Refers to other facts, causes, or consequences

- ☞ Provides additional information



Environmentally sound disposal

1. Safety instructions



The operator of the described product must ensure that the operating instructions are read and understood by all persons responsible for assembly, operation, maintenance, and repair of the product. The operating instructions must be kept readily available.



Note that the operating instructions form part of the product and must accompany the product if sold to a new owner.

The described product is manufactured in accordance with the generally accepted rules and standards of industry practice and with occupational safety and accident prevention regulations. Risks may, however, arise from its usage and may result in physical harm to persons or damage to other material assets. Therefore the product may only be used in proper technical condition and in observance of the operating instructions. In particular, any malfunctions which may affect safety must be remedied immediately.



In addition to the operating instructions, statutory regulations and other general regulations for accident prevention in railways (railway regulations) and environmental protection must be observed and applied.

1.1 Intended use

The curve sensor control unit LCG2-A04, LCG2-A07 and LCG2-A08 are used for wheel flange lubrication and top of rail conditioning in vehicles without compressed air (single-line SKF EasyRail Airless system) in railway applications.

It is not suitable for performing safety-related functions or for detecting curve travel in conjunction with tilt-train technology. It is likewise unsuitable for use in aviation equipment or for the purpose of navigation in any kind of vehicle or ships.

Any other usage is deemed non-compliant with the intended use.

Hazardous materials of any kind, especially the materials classified as hazardous by CLP Regulation EC 1272/2008 may only be used to fill SKF centralized lubrication systems and components and delivered and/or distributed with the same after consulting with and receiving written approval from SKF.

The described product is neither designed nor approved for use in conjunction with gases, liquefied gases, pressurized gases in solution, vapors, or such fluids whose vapor pressure exceeds normal atmospheric pressure (1013 mbar) by more than 0.5 bar at their maximum permissible temperature.

Unless specially indicated otherwise, products from SKF Lubrication Systems Germany GmbH are not approved for use in potentially explosive areas as defined in the ATEX Directive 94/9/EC.

1.2 Authorized personnel

Only qualified technical personnel may install, operate, maintain, and repair the product described in the operating instructions. Qualified technical personnel are persons who have been trained, assigned, and instructed by the operator of the final product into which the described product is incorporated. Such persons are familiar with the relevant standards, rules, accident prevention regulations, and assembly conditions as a result of their training, experience, and instruction. They are qualified to carry out the required activities and in doing so recognize and avoid any potential hazards.

The definition of qualified personnel and the prohibition against employing non-qualified personnel are laid down in DIN VDE 0105 and IEC 364.

1.3 Electric shock hazard

Electrical connections for the described product may only be established by qualified and trained personnel authorized to do so by the operator, and in observance of the local conditions for connections and local regulations (e.g., DIN, VDE). Serious injury or death and property damage may result from improperly connected products.



Danger!

Performing work on an energized pump or product may result in serious injury or death.

Assembly, maintenance, and repair work may only be performed on products that have been de-energized by qualified technical personnel. The supply voltage must be switched off before opening any of the product's components.

1.4 System pressure hazard



Danger!

Lubrication systems are pressurized during operation. Centralized lubrication systems must therefore be depressurized before starting assembly, maintenance, or repair work, or any system modifications or system repairs.



Danger!

Do not spray people or animals with lubricant.

2. Transport, delivery, and storage

2.1 General

SKF Lubrication Systems Germany GmbH products are packaged in accordance with standard commercial practice according to the regulations of the recipient's country and DIN ISO 9001. During transport, safe handling must be ensured and the product must be protected from mechanical effects such as impacts. The transport packaging must be marked "Do not drop!".

There are no restrictions for land, air, or sea transport.

After receipt of the shipment, the product(s) must be inspected for damage and for completeness according to the shipping documents. Keep the packaging material until any discrepancies have been resolved.

SKF Lubrication Systems Germany GmbH products are subject to the following storage conditions:

2.2 Electronic and electrical devices

- Ambient conditions: dry and dust-free surroundings, storage in well ventilated dry area
- Storage time: max. 24 months
- Permissible humidity: < 65%
- Storage temperature: -40 to +85°C
- Light: Avoid direct sun or UV exposure and shield nearby sources of heat

2.3 General notes

- The product(s) can be enveloped in plastic film to provide low-dust storage.
- Protect against ground moisture by storing on a shelf or wooden pallet.
- At approx. 6-month intervals: Check for corrosion. If there are signs of corrosion, reapply anti-corrosive agents.

3. Overview

3.1 Usage

The curve sensor control unit LCG2-A04, LCG2-A07 and LCG2-A08 are used for wheel flange lubrication and top of rail conditioning in vehicles without compressed air (single-line SKF EasyRail Airless system).

The lubrication system described below does not require any compressed air.

3.2 Design

The curve sensor control units LCG2-A04, LCG2-A07 and LCG2-A08 are only available in the DC 24 V design (housing type A).

They differ only in having different interval times between successive lubrication pulses (-see pages 48/59/52/54/56, Table B) and in the function of pushbutton DK on the

LCG2-A08 (see Table 7).

Order number for the basic design (see Figure 2):
 LCG2-A04-000+924
 or : LCG2-A07-000+924
 LCG2-A08-000+924

3.3 Mounting position and information on electrical installation

The LCG2-A04 curve sensor control unit can actuate a maximum of one electromagnetic pump. Additional electrical control components are required to operate more than one electromagnetic pump. To control two electromagnetic pumps, SKF offers a fully assembled compact control cabinet that also houses the LCG2-A04. For the curve sensor function, the LCG2-A04 must be installed vertically with the cable outlet pointing downwards. If the dimensions of the control cabinet do not permit this prescribed mounting position, the LCG2-A04 can also be installed outside the control cabinet.

See control cabinet drawing 173-000-297 and standard wiring diagram 951-140-314 for the dimensions and configuration.

Order number key for control unit LCG2-A04 and LCG2-A07, Table 1

LCG2-A04-000+924, LCG2-A07-000+924 and LCG2-A08-000+924

LCG2 - A 04 - 000 +924
 LCG2
 -A
 04 or 07 or 08
 -XXX
 +924

Device type
 Housing type
 Software version - see table B
 Placeholder for special mechanical designs (on request)
 Voltage key for DC 24 V

Order number key for the electromagnetic pump, Table 2

PER -X -XX +924
 PER -1
 -2
 -20
 -40
 -60
 +924

1 lubrication nozzle
 2 lubrication nozzles
 20 mm³/stroke
 40 mm³/stroke
 60 mm³/stroke
 Voltage key for 24 VDC

3.4 Feeding and application of lubricant (standard lubrication system)

A lubricant pump with reservoir (e.g., type KFG1-5+924) feeds the lubricant through a ring line and into the metering chambers of two electromagnetic pumps. The pulsed actuation by the electromagnetic pumps sprays the metered quantity of lubricant to the lubricant points (lubrication pulse) via nozzles.

The nozzles are located on body of the electromagnetic pump, which is installed immediately adjacent to the lubrication point. On pump bodies with two nozzles, they are arranged so that the wheel flange and rear of the wheel can be lubricated simultaneously (e.g., for vehicles on grooved rails).

With each lubrication pulse, the lubricant pump is switched on and only switched off again after a set delay time t_v elapses so that the metering chambers can be refilled. Excess lubricant is returned to the lubricant reservoir via the ring line.

The electromagnetic pumps are equipped with a temperature-controlled heating system that ensures lubricant delivery even in cold conditions.

Example of a wheel flange and wheel rear lubrication system with LCG2-A04 control unit, 1.1

Example lubrication system for operation with two electromagnetic pumps with two nozzles each.

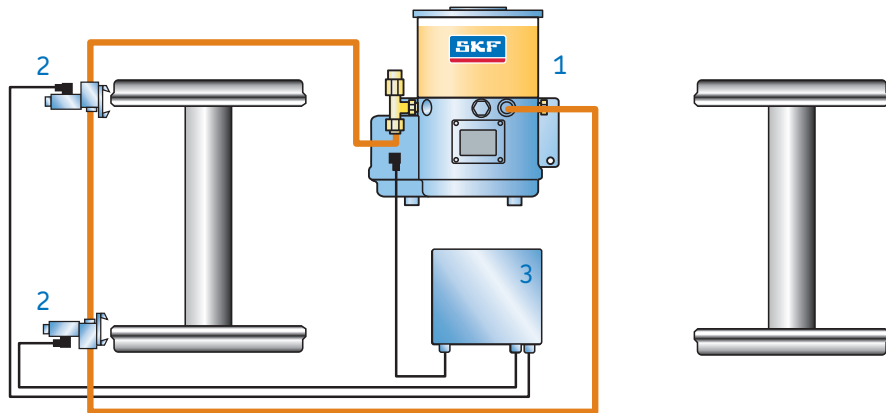

1. Lubricant pump with reservoir
2. Electromagnetic pump with two nozzles and integrated heating
3. Compact control cabinet with LCG2-A04 control unit

Example of a top of rail conditioning system with LCG2-A04 control unit, Fig. 1.2

Example lubrication system for operation with two electromagnetic pumps with one nozzle each.

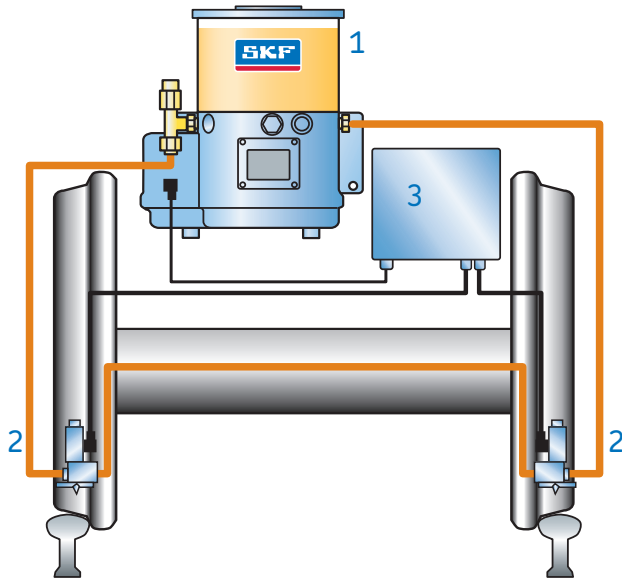

1. Lubricant pump with reservoir
2. Electromagnetic pump with one nozzle and integrated housing
3. Compact control cabinet with LCG2-A04 control unit

4. Design and function

4.1 Configuration of the LCG2-A04, LCG2-A07 and LCG2-A08

Components of LCG2 control unit, Fig. 2

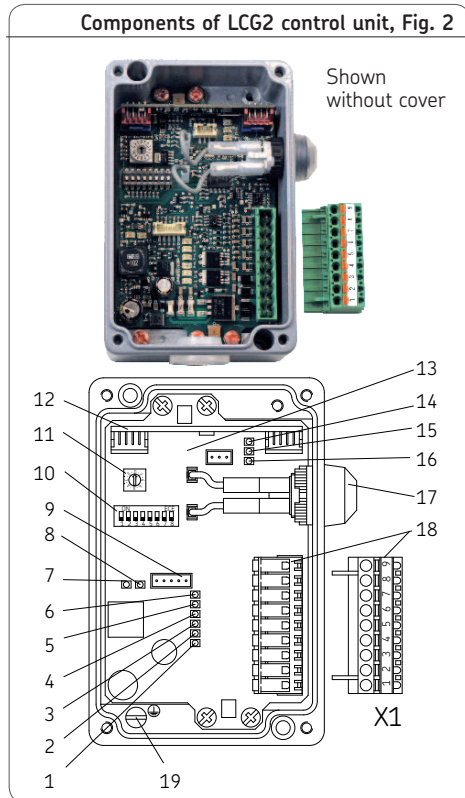

Components and function of LCG2 control unit, legend to Fig. 2

Item	Component	Function	
1	LED, green	Outlet A1	Electromagnetic pump (lubrication pulse)
2	LED, green	Outlet A2	Lubricant pump
3	LED, yellow	Input FG	Lubrication enable
4	LED, yellow	Input terminal X1:6	No function
5	LED, yellow	Input DK	Pushbutton DK (manual lub. pulse triggering)
6	LED, yellow	Input +P	Distance pulse signal, logical 1
7	LED, green	Operating voltage	Operating voltage connected
8	LED, red	Reset	Trigger program restart (temporary signal)
9	Programming interface		
10	DIP switches S1 to S8	System configuration	Configuration of functional parameters
11	Rotary switch S9	Curve sensor configuration	Sensor activation and sensitivity configuration
12	Sensor circuit board		
13	Main circuit board		
14	LED, red	Program start	Initialization complete (temporary signal)
15	LED, yellow	Program start	Initialization complete (temporary signal)
16	LED, green	Input +P/-P	Frequency-dependent lubrication enable
17	Pushbutton (DK)		Manual lubrication pulse triggering
18	Electrical plug connector X1		Socket for customer wiring
19	Protective earth conductor PE		Socket for customer wiring

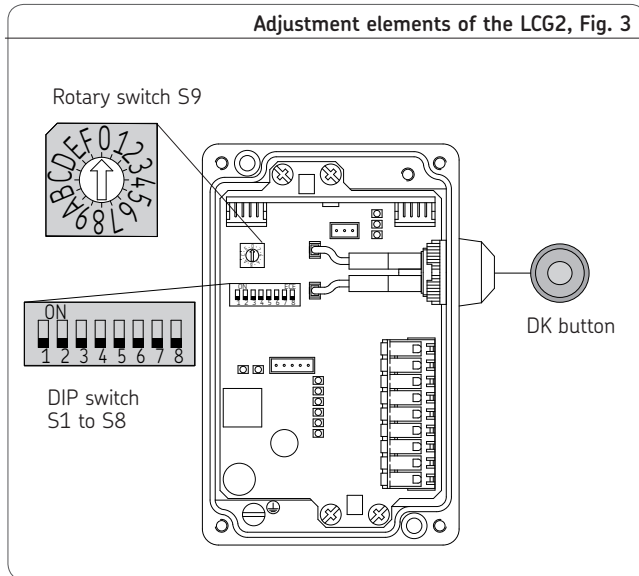
**Legend to Fig. 3****Rotary switch S9**

Deactivation, activation, and sensitivity setting of curve sensor

DIP switches S1 to S8

Setting for operating mode and other functional parameters

- S1** - Preselects time- or distance-dependent lubrication
- S2** - Interval time t_p between successive lubrication pulses
- S3 to S4** - Sets the number of successive lubrication pulses per lubrication cycle when using time- or distance-dependent lubrication
- S5 to S8** - Deactivates or activates operating mode preselected with S1 by configuring the lubrication period duration for time- or distance-dependent lubrication

Pushbutton DK

- see function table 7, page 34

4.2 Function

4.2.1 Lubricant pump function

With each lubricant pulse delivered (regardless of operating mode), the lubricant pump is switched on for a period of 10 seconds via output A2. When multiple lubrication pulses follow in sequence, the lubrication pump remains activated and is only switched off again with a 10 second delay after the last lubrication pulse.

4.3 Curve-dependent lubrication

Based on the type of curve sensor employed, the LCG2-A04 curve sensor control unit is designed for line profiles that on statistical average yield a straight line, i.e., the distribution of left and right curves must be approximately equal. A microcontroller generates a moving median value from the sensor parameters for the straight lines and curves traveled. This value is used for continuous adjustment of the reference angular velocity of 0 degrees/s. Aging and temperature fluctuations in the sensor chip are also compensated for.

4.3.1 Preselection

Position "0" on rotary switch S9 deactivates the curve sensor function (factory setting). The sensitivity of the curve sensor can be set in angular degrees per second using switch settings "1" to "F" as shown in Table F. If only curve-dependent lubrication is to be performed, the setting for DIP switch S1 must also be considered (see Chapter 6.2.2).

4.3.2 Function

The curve sensor integrated into the LCG2-A04 sends a curve signal once the pre-set sensitivity threshold is reached while the rail vehicle is traveling through a curve. The control unit evaluates the signal and triggers a lubrication pulse via output A1 once the lubrication enable conditions are met. In case of an extended-duration curve signal, the electromagnetic pump operates at a lubrication pulse time t_s of 0.2 seconds (non-adjustable) and a lubrication interval time t_p of 1 or 2 seconds (version A04) or interval time t_p of 2 or 4 seconds (version A07) (adjustable via DIP switch S2, see table B).

Curve-dependent lubrication in combination with other operating modes:

Curve detection has no effect while a time- or distance-dependent lubrication pulse sequence is ongoing. The corresponding curve-dependent lubrication pulse is skipped.

Program start once operating voltage is connected:

Each time the operating voltage is switched on, a waiting period of approx. 6 seconds is required for the automatic "curve zeroing" before the vehicle is moved.

4.3.3 Lubrication enable

Lubrication enable condition, Table 3

Lubrication enable condition when using curve-dependent lubrication:

- Enable input FG connected (switching contact FG closed)

Lubrication enable condition when using combined curve- and time-dependent lubrication:

- Enable input FG connected (switching contact FG closed)

Lubrication enable conditions when using combined curve- and distance-dependent lubrication:

- Enable input FG connected (switching contact FG closed)
- and
- Pulse frequency at input +P/-P is greater than 3.5 Hz (minimum travel speed has been reached)

4.3.4 Functional diagrams

The following pages contain functional diagrams with various lubrication enable situations for illustrative purposes.



The figures are not true to scale.

Lubrication functions, Table 4

Function	Figure
Curve-dependent lubrication with continuous FG lubrication enable	4.1
Curve-dependent lubrication with intermittent FG lubrication enable	4.2
Curve-dependent lubrication with FG lubrication enable and additional lubrication enable via minimum frequency at input +P/-P	4.3

Curve-dependent lubrication with continuous FG lubrication enable, Fig. 4.1

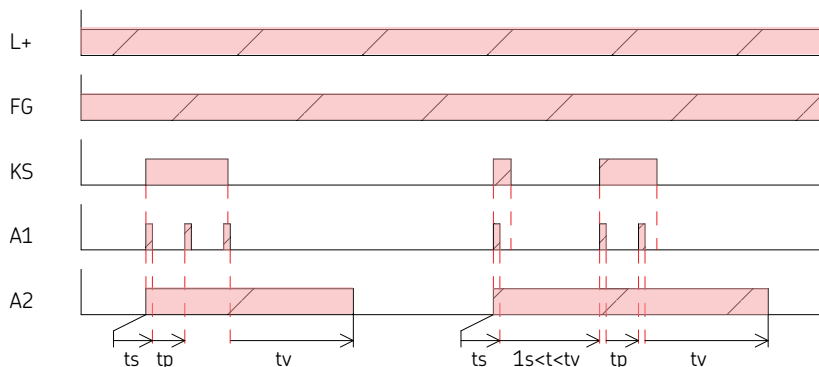

Setting example:

Setting	Typ	Function	Adjusting table (see pages 44–45)
Operating mode (time-dependent but deactivated):		Time-dependent	A
Rotary switch S9 (curve sensor activated):		8	F
Lubrication period time:		Deactivated	D
Number of lubrication pulses (burst); output A1:		2 (not relevant)	C
Lubrication interval time t_p , output A1:	LCG2-A04	1 s	B
	LCG2-A07	2 s	B
	LCG2-A08	2.5 s	B

Legend to Fig. 4.1

Abbreviation	Legend
L+	Operating voltage
FG	Enable input
KS	Curve sensor (internal signal: curve travel detected)
A1	Output for electromagnetic pump
A2	Output for lubricant pump
t_s	Lubrication pulse time (0.2 seconds, non-adjustable)
t_p	Lubrication interval time
t_v	Lubricant pump; switch-off delay time (10 seconds, non-adjustable)

Settings made according to adjusting tables:
Chapter 6.2.2, pages 44 to 45

Curve-dependent lubrication with intermittent FG lubrication enable, Fig. 4.2

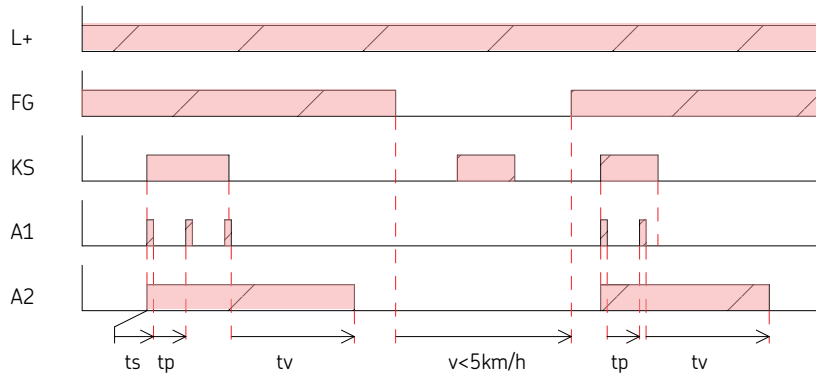

Setting example:

Setting	Typ	Function	Adjusting table (see pages 44-45)
Operating mode (time-dependent but deactivated):		Time-dependent	A
Rotary switch S9 (curve sensor activated):		8	F
Lubrication period time:		Deactivated	D
Number of lubrication pulses (burst); output A1:		2 (not relevant)	C
Lubrication interval time t_p , output A1:	LCG2-A04	1 s or 2 s	B
	LCG2-A07	2 s or 4 s	B
	LCG2-A08	2.5 s or 2 s	B

Legend to Fig. 4.2

Abbreviation	Legend
L+	Operating voltage
FG	Enable input
KS	Curve sensor (internal signal: curve travel detected)
A1	Output for electromagnetic pump
A2	Output for lubricant pump
t_s	Lubrication pulse time (0.2 seconds, non-adjustable)
t_p	Lubrication interval time
t_v	Lubricant pump; switch-off delay time (10 seconds, non-adjustable)

Settings made according to adjusting tables:
Chapter 6.2.2, pages 44 to 45

Curve-dependent lubrication with FG lubrication enable and additional lubrication enable
via minimum frequency on input +P/-P **Fig. 4.3**

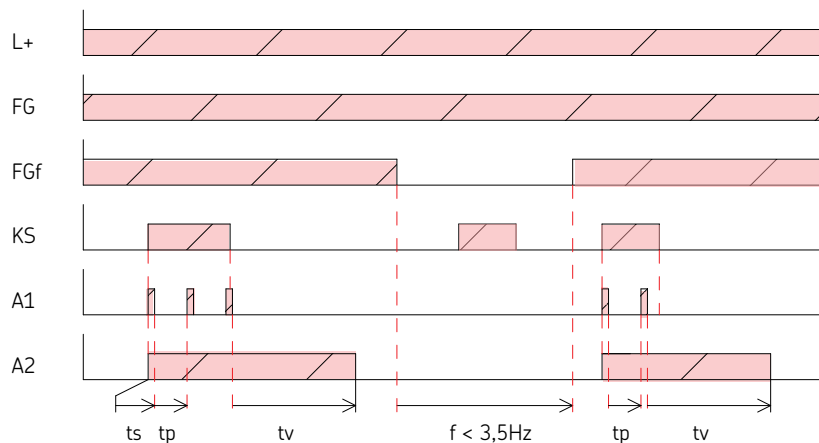

Setting example:

Setting	Typ	Function	Adjusting table (see pages 44–45)
Operating mode (time-dependent but deactivated):		Distance-dependent	A
Rotary switch S9 (curve sensor activated):		8	F
Lubrication period duration in number of pulses:		Deactivated	E
Number of lubrication pulses (burst); output A1:		2 (not relevant)	C
Lubrication interval time t_p , output A1:	LCG2-A04	1 s or 2 s	B
	LCG2-A07	2 s or 4 s	B
	LCG2-A08	2.5 s or 2 s	B

Legend to Fig. 4.3

Abbreviation	Legend
L+	Operating voltage
FG	Enable input
KS	Curve sensor (internal signal: curve travel detected)
FGf	Enable frequency (internal signal: pulse frequency at input +P/-P is > 3.5 Hz)
A1	Output for electromagnetic pump
A2	Output for lubricant pump
t_s	Lubrication pulse time (0.2 seconds, non-adjustable)
t_p	Lubrication interval time
t_v	Lubricant pump; switch-off delay time (10 seconds, non- adjustable)

Settings made according to adjusting tables:
Chapter 6.2.2, pages 44 to 45

4.4 Time- or distance-dependent lubrication

DIP switch 1 defines a preselection for the following operating modes (see Table A):

- **DIP switch S1 = OFF:**
Time-dependent lubrication (factory setting)
- **DIP switch S1 = ON:**
Distance-dependent lubrication

The preselected operating mode is only effectively activated once at least one of the DIP switches from S5 to S8 is switched to the ON position.

If only curve-dependent lubrication is to be performed, DIP switches S5 to S8 remain in the OFF position (factory setting).

Lubrication enable conditions

Setting DIP switch S1 also defines the lubrication enable conditions irrespective of whether the preselected operating mode is activated using DIP switches S5 to S8:

- **DIP switch S1 = OFF:**
Lubrication enable only via input FG (factory setting)
- **DIP switch S1 = ON:**
Lubrication enable via input FG and minimum pulse frequency on input +P/-P

4.5 Time-dependent lubrication

4.5.1 Preselection

If time-dependent lubrication is to be performed, the lubrication period time T in seconds is set using DIP switches S5 to S8 after preselection using DIP switch S1 (see Chapter 4.3.4) (see Table D).

4.5.2 Function

A time-dependent lubrication operation on the LCG2-A04 does not consist of a lubrication pulse. Rather, it is always composed of 2 to 5 accumulated lubrication pulses -A04/-A07 or 1 to 4 accumulated lubrication pulses -A08 (see Table C), each of which is interrupted by a lubrication interval time t_p (see Table B). This lubrication operation starts periodically after a certain preselected time T in seconds and once the lubrication enable conditions are met.

Lubrication operation duration [s]+ remaining time [s] = preset lubrication period time T [s] according to Table D.

4.5.3 Lubrication enable

In order to better distribute the lubricant along the rail network, a random number generator defines a lead time between zero and the set lubrication duration in seconds each time the operating voltage is connected on the LCG2-A04. If all lubrication enable conditions are met, the operational sequence begins with this lead time; once this lead time has elapsed, the first time-dependent lubrication operation is performed and a lubrication period starts according to the preselected time.

Time-dependent lubrication in combination with curve-dependent lubrication:

If the lubrication period time elapses during a curve-dependent lubrication pulse, this pulse continues to completion and is followed by a lubrication interval time t_p . The pending time-dependent lubrication operation is performed immediately thereafter.

Lubrication enable condition when using time-dependent lubrication:

- Enable input FG connected (switching contact FG closed)

Enable contact FG can open depending on usage, for example during very slow travel, when the vehicle is stationary, or during a braking or sanding procedure.

If enable contact FG opens while a lubrication operation is ongoing, a lubrication pulse that has already begun still continues to completion but any remaining lubrication pulses will not. The time counter for the lubrication period is stopped.

If enable contact FG opens after a lubrication operation, the time counter for the lubrication period is stopped.

If switching contact FG then closes again, the counter for the lubrication period will resume. A new lubrication operation is started if the lubrication is completed.

To prevent time-dependent lubrication when the vehicle is stationary, enable input FG must not be hard-wired to +24V operating voltage potential in this operating mode. There must be support for a signal from the vehicle control system which switches the lubrication function on and off depending on the situation.

4.5.4 Functional diagrams

The following pages contain functional diagrams with various lubrication enable situations for illustrative purposes.



The figures are not true to scale.

Lubrication functions, Table 5

Function	Figure
Time-dependent lubrication with continuous FG lubrication enable	4.4
Time-dependent lubrication with continuous FG lubrication enable	4.5
Time-dependent lubrication with intermittent FG lubrication enable	4.6

Time-dependent lubrication with continuous FG lubrication enable, Fig. 4.4

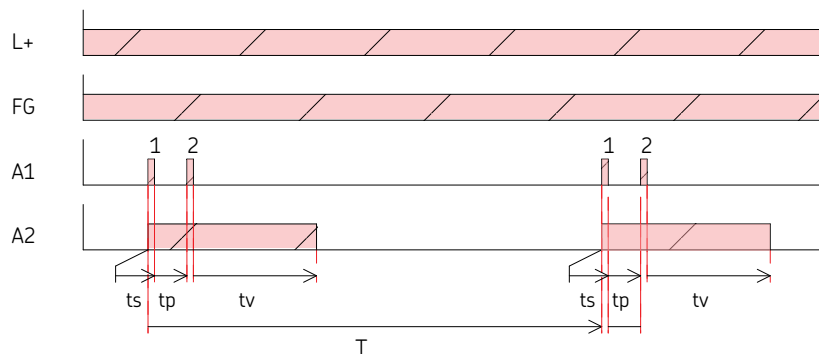

Setting example:

Setting	Typ	Function	Adjusting table (see pages 46-47)
Operating mode:		Time-dependent	A
Rotary switch S9 (curve sensor deactivated):		0	F
Lubrication period time T:		40 s	D
Number of lubrication pulses (burst); output A1:		2	C
Lubrication interval time t_p , output A1:	LCG2-A04	1 s or 2 s	B
	LCG2-A07	2 s or 4 s	B
	LCG2-A08	2.5 s or 2 s	B

Legend to Fig. 4.4

Abbreviation Legend

L+	Operating voltage
FG	Enable input
A1	Output for electromagnetic pump
A2	Output for lubricant pump
t_s	Lubrication pulse time (0.2 seconds, non-adjustable)
t_p	Lubrication interval time
t_v	Lubricant pump; switch-off delay time (10 seconds, non-adjustable)
T	Lubrication period time

Settings made according to adjusting tables:
Chapter 6.2.3, pages 46 to 47.

Time-dependent lubrication with continuous FG lubrication enable, Fig. 4.5

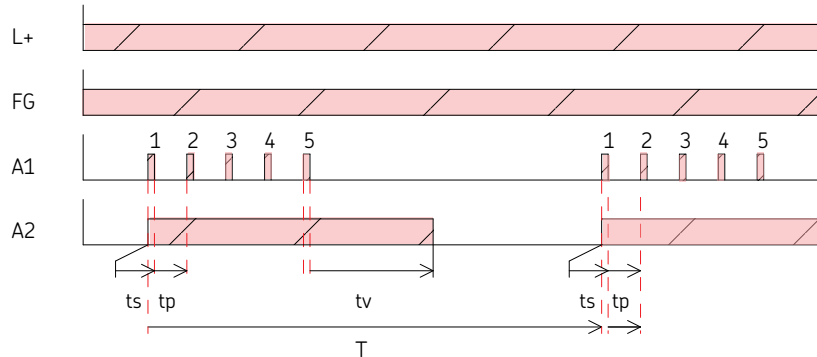

Setting example:

Setting	Typ	Function	Adjusting table (see pages 46-47)
Operating mode:		Time-dependent	A
Rotary switch S9 (curve sensor deactivated):		0	F
Lubrication period time T:		100 s	D
Number of lubrication pulses (burst); output A1:		5	C
Lubrication interval time tp, output A1:	LCG2-A04	1 s or 2 s	B
	LCG2-A07	2 s or 4 s	B
	LCG2-A08	2.5 s or 2 s	B

Legend to Fig. 4.5

Abbreviation Legend

L+	Operating voltage
FG	Enable input
A1	Output for electromagnetic pump
A2	Output for lubricant pump
ts	Lubrication pulse time (0.2 seconds, non-adjustable)
tp	Lubrication interval time
tv	Lubricant pump; switch-off delay time (10 seconds, non-adjustable)
T	Lubrication period time

Settings made according to adjusting tables:
Chapter 6.2.3, pages 46 to 47.

Time-dependent lubrication with intermittent FG lubrication enable, Fig. 4.6

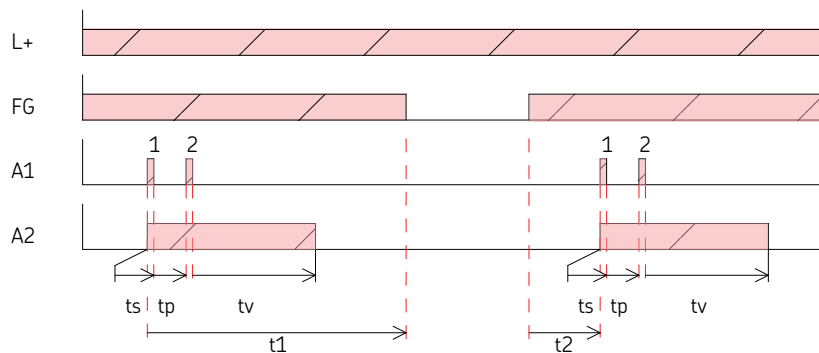

Setting example:

Setting	Typ	Function	Adjusting table (see pages 46-47)
Operating mode:		Time-dependent	A
Rotary switch S9 (curve sensor deactivated):		0	F
Lubrication period time T:		100 s	D
Number of lubrication pulses (burst); output A1:		2	C
Lubrication interval time t_p , output A1:	LCG2-A04	1 s or 2 s	B
	LCG2-A07	2 s or 4 s	B
	LCG2-A08	2.5 s or 2 s	B

Legend to Fig. 4.6

Abbreviation Legend

L+	Operating voltage
FG	Enable input
A1	Output for electromagnetic pump
A2	Output for lubricant pump
t_s	Lubrication pulse time (0.2 seconds, non-adjustable)
t_p	Lubrication interval time
t_v	Lubricant pump; switch-off delay time (10 seconds, non-adjustable)
T	Lubrication period time = $t_1 + t_2$

Settings made according to adjusting tables:
Chapter 6.2.3, pages 46 to 47.

4.6 Distance-dependent lubrication

4.6.1 Preselection

If distance-dependent lubrication is to be performed, the lubrication period duration in number of distance pulses is set using DIP switches S5 to S8 after preselection using DIP switch S1 (see Chapter 4.3.4) (see Table E).

4.6.2 Function

For distance-controlled lubrication, the LCG2-A04 features pulse input +P/-P, which receives pulses from the vehicle's pulse generator proportional to the distance traveled.

A distance-dependent lubrication operation on the LCG2-A04 does not consist of a lubrication pulse. Rather, it is always composed of 2 to 5 accumulated lubrication pulses (see Table C), each of which is interrupted by a lubrication interval time t_p (see Table B). This lubrication operation starts periodically after a certain preselected number of distance pulses has been received on input +P/-P and once the lubrication enable conditions are met.

Distance of lubrication operation [pulses] + remaining distance [pulses] = preselected distance [pulses] according to Table E

Pulses = number of distance pulses on input +P/-P.

In order to better distribute the lubricant along the rail network, a random number generator defines a number of pulses between zero and the preselected number of distance pulses each time the operating voltage is connected on the curve sensor control unit. The operational sequence begins at this number of pulses; once the number of pulses has been reached, the first distance-dependent lubrication operation is performed and a lubrication period starts according to the preselected number of distance pulses.

4.6.3 Lubrication enable

Lubrication enable conditions when using distance-dependent lubrication:

- Enable input FG connected (switching contact FG closed) and
- Pulse frequency at input +P/-P is greater than 3.5 Hz (minimum travel speed has been reached)

Enable contact FG can open depending on usage, e.g., during very slow travel, when the vehicle is stationary, or during a braking or sanding procedure. The minimum pulse frequency on input +P/-P prevents lubrication during excessively slow travel or while the vehicle is stationary. Input FG can also be bridged with +24V operating voltage if no other situation requiring lubrication suppression is anticipated.

Counting of the distance pulses is not stopped if one of the lubrication enable conditions is no longer met, for example due to excessively

slow travel. The distance counter is reset upon reaching the preselected number of distance pulses, though the lubrication process is only performed once both lubrication enable conditions are again met. This lubrication operation is triggered with a delay, though the subsequent one is performed in sync with the distance counter.

If one or both lubrication enable conditions are no longer met during a lubrication operation, a lubrication pulse that has already begun still continues to completion but any remaining lubrication pulses will not.

Distance-dependent lubrication in combination with curve-dependent lubrication:

If the lubrication period elapses during a curve-dependent lubrication pulse, only this pulse continues to completion and is followed by a lubrication interval time t_p . The pending distance-dependent lubrication operation is performed immediately thereafter.

4.6.4 Determining the preset value for distance

The number of pulses to be set corresponds to a certain distance traveled. In order to determine this setting, the number of pulses issued per meter by the pulse generator must be known. Multiply this number by the desired number of meters traveled between lubrications. Then set the value in Table E that is closest to the resulting number.

Example calculation:

The pulse generator issues 2 pulses per meter. Lubrication is to be performed approximately every 500 meters.

Calculation: 500 meters 2 pulses/meter
Result: 1000 pulses

The closest setting for the number of pulses is thus 1125 pulses (corresponding to a distance of 562.5 meters).



Note

When determining the number of pulses to set for the distance, you must also take into account the specifications given in the data sheet for input +P/-P, such as voltage, max. pulse frequency, and pulse duty factor.

4.6.5 Functional diagrams

The following pages contain functional diagrams with various lubrication enable situations for illustrative purposes.



The figures are not true to scale.

Lubrication functions, Table 6

Function	Figure
Distance-dependent lubrication with continuous FG lubrication enable	4.7
Distance-dependent lubrication with continuous FG lubrication enable	4.8
Distance-dependent lubrication with intermittent FG lubrication enable with number of distance pulses not yet achieved,	4.9
Distance-dependent lubrication with intermittent FG lubrication enable with number of distance pulses achieved,	4.10
Distance-dependent lubrication below minimum enable frequency (< 3.5 Hz) at input +P/-P with number of distance pulses achieved	4.11
Distance-dependent lubrication with interruption of FG lubrication enable during a lubrication operation	4.12

Distance-dependent lubrication with continuous FG lubrication enable, Fig. 4.7

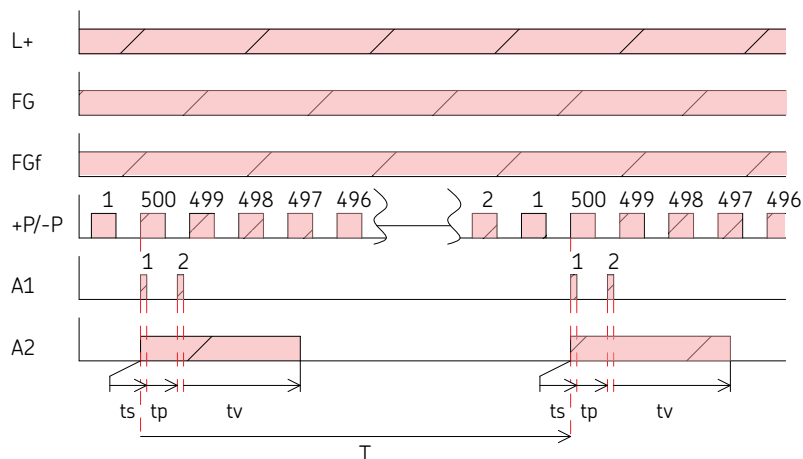

Setting example:

Setting	Typ	Function	Adjusting table (see pages 50-51)
Operating mode:		Distance-dependent	A
Rotary switch S9 (curve sensor deactivated):		0	F
Lubrication period duration T:		500 pulses	E
Number of lubrication pulses (burst); output A1:		2	C
Lubrication interval time t_p , output A1:	LCG2-A04	1 s or 2 s	B
	LCG2-A07	2 s or 4 s	B
	LCG2-A08	2.5 s or 2 s	B

Legend to Fig. 4.7

Abbreviation Legend

L+	Operating voltage
FG	Enable input
FGf	Enable frequency (internal signal: pulse frequency at input +P/-P is > 3.5 Hz)
+P/-P	Input for distance-dependent pulses
A1	Output for electromagnetic pump
A2	Output for lubricant pump
t_s	Lubrication pulse time (0.2 s non-adjustable)
t_p	Lubrication interval time
t_v	Lubricant pump; switch-off delay time (10 s non-adjustable)
T	Lubrication period duration in number of distance-dependent pulses

Settings made according to adjusting tables: Chapter 6.2.5, pages 50 to 51.

Distance-dependent lubrication with continuous FG lubrication enable, Fig. 4.8

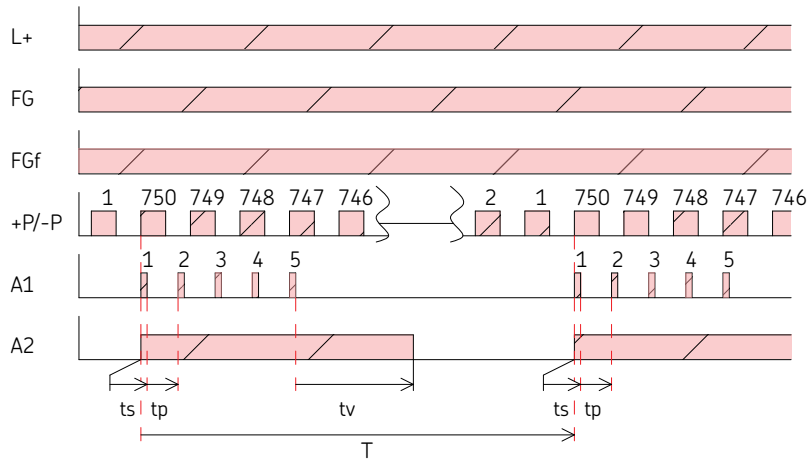

Setting example:

Setting	Typ	Function	Adjusting table (see pages 50-51)
Operating mode:		Distance-dependent	A
Rotary switch S9 (curve sensor deactivated):		0	F
Lubrication period duration T:		750 pulses	E
Number of lubrication pulses (burst); output A1:		5	C
Lubrication interval time tp, output A1:	LCG2-A04	1 s or 2 s	B
	LCG2-A07	2 s or 4 s	B
	LCG2-A08	2.5 s or 2 s	B

Legend to Fig. 4.8

Abbreviation Legend

L+	Operating voltage
FG	Enable input
FGf	Enable frequency (internal signal: pulse frequency at input +P/-P is > 3.5 Hz)
+P/-P	Input for distance-dependent pulses
A1	Output for electromagnetic pump
A2	Output for lubricant pump
ts	Lubrication pulse time (0.2 s non-adjustable)
tp	Lubrication interval time
tv	Lubricant pump; switch-off delay time (10 s non-adjustable)
T	Lubrication period duration in number of distance-dependent pulses

Settings made according to adjusting tables:
Chapter 6.2.5, pages 50 to 51.

Distance-dependent lubrication with intermittent FG lubrication enable
with number of distance pulses not yet achieved,

Fig. 4.9

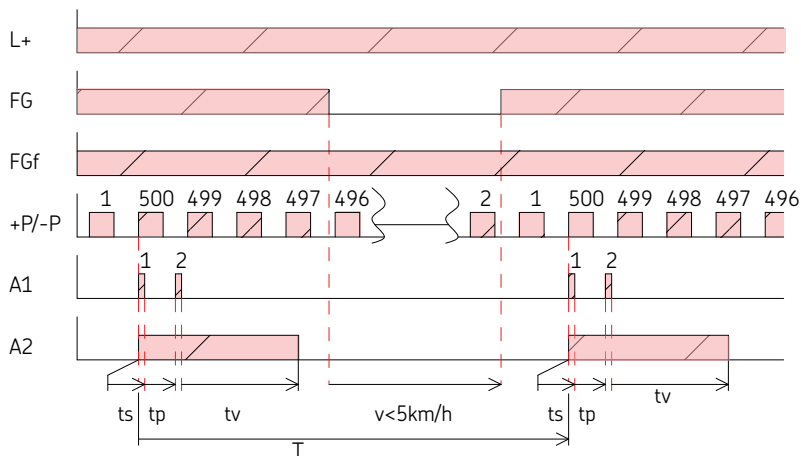

Setting example:

Setting	Typ	Function	Adjusting table (see pages 50-51)
Operating mode:		Distance-dependent	A
Rotary switch S9 (curve sensor deactivated):		0	F
Lubrication period duration T:		500 pulses	E
Number of lubrication pulses (burst); output A1:		2	C
Lubrication interval time tp, output A1:	LCG2-A04	1 s or 2 s	B
	LCG2-A07	2 s or 4 s	B
	LCG2-A08	2.5 s or 2 s	B

Legend to Fig. 4.9

Abbreviation Legend

L+	Operating voltage
FG	Enable input
FGf	Enable frequency (internal signal: pulse frequency at input +P/-P is > 3.5 Hz)
+P/-P	Input for distance-dependent pulses
A1	Output for electromagnetic pump
A2	Output for lubricant pump
ts	Lubrication pulse time (0.2 s non-adjustable)
tp	Lubrication interval time
tv	Lubricant pump; switch-off delay time (10 s non-adjustable)
T	Lubrication period duration in number of distance-dependent pulses

Settings made according to adjusting tables:
Chapter 6.2.5, pages 50 to 51.

Distance-dependent lubrication with intermittent FG lubrication enable
with number of distance pulses achieved,

Fig. 4.10

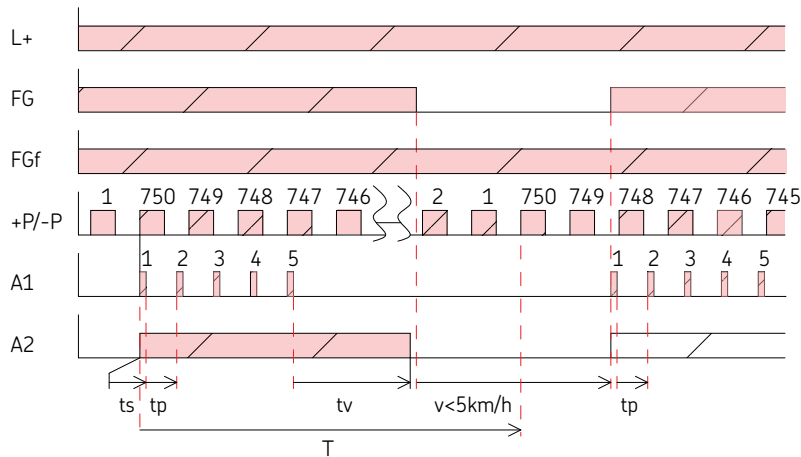

Setting example:

Setting	Typ	Function	Adjusting table (see pages 50-51)
Operating mode:		Distance-dependent	A
Rotary switch S9 (curve sensor deactivated):		0	F
Lubrication period duration T:		750 pulses	E
Number of lubrication pulses (burst); output A1:		5	C
Lubrication interval time tp, output A1:	LCG2-A04	1 s or 2 s	B
	LCG2-A07	2 s or 4 s	B
	LCG2-A08	2.5 s or 2 s	B

Legend to Fig. 4.10

Abbreviation Legend

L+	Operating voltage
FG	Enable input
FGf	Enable frequency (internal signal: pulse frequency at input +P/-P is > 3.5 Hz)
+P/-P	Input for distance-dependent pulses
A1	Output for electromagnetic pump
A2	Output for lubricant pump
ts	Lubrication pulse time (0.2 s non-adjustable)
tp	Lubrication interval time
tv	Lubricant pump; switch-off delay time (10 s non-adjustable)
T	Lubrication period duration in number of distance-dependent pulses

Settings made according to adjusting tables:
Chapter 6.2.5, pages 50 to 51.

Distance-dependent lubrication below minimum enable frequency (< 3.5 Hz) at input +P/-P with number of distance pulses achieved,

Fig. 4.11

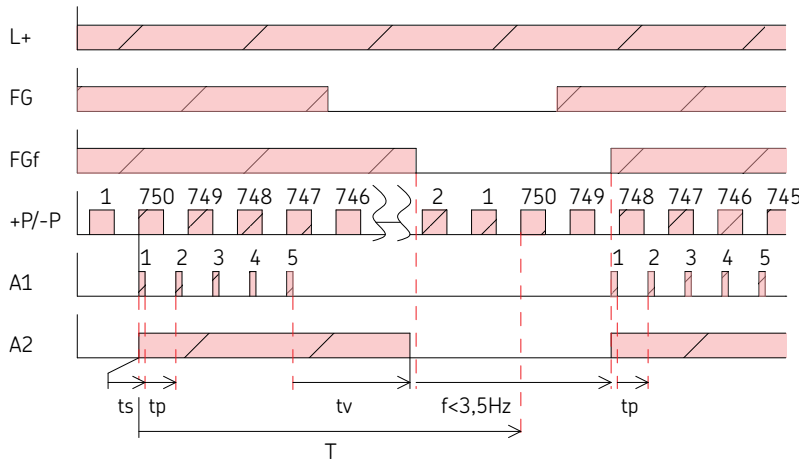

Setting example:

Setting	Typ	Function	Adjusting table (see pages 50-51)
Operating mode:		Distance-dependent	A
Rotary switch S9 (curve sensor deactivated):		0	F
Lubrication period duration T:		750 pulses	E
Number of lubrication pulses (burst); output A1:		5	C
Lubrication interval time tp, output A1:	LCG2-A04	1 s or 2 s	B
	LCG2-A07	2 s or 4 s	B
	LCG2-A08	2.5 s or 2 s	B

Legend to Fig. 4.11

Abbreviation Legend

- L+ Operating voltage
- FG Enable input
- FGf Enable frequency (internal signal: pulse frequency at input +P/-P is > 3.5 Hz)
- +P/-P Input for distance-dependent pulses
- A1 Output for electromagnetic pump
- A2 Output for lubricant pump
- ts Lubrication pulse time (0.2 s non-adjustable)
- tp Lubrication interval time
- tv Lubricant pump; switch-off delay time (10 s non-adjustable)
- T Lubrication period duration in number of distance-dependent pulses

Settings made according to adjusting tables: Chapter 6.2.5, pages 50 to 51.

Distance-dependent lubrication with interruption of FG lubrication enable during a lubrication operation,

Fig. 4.12

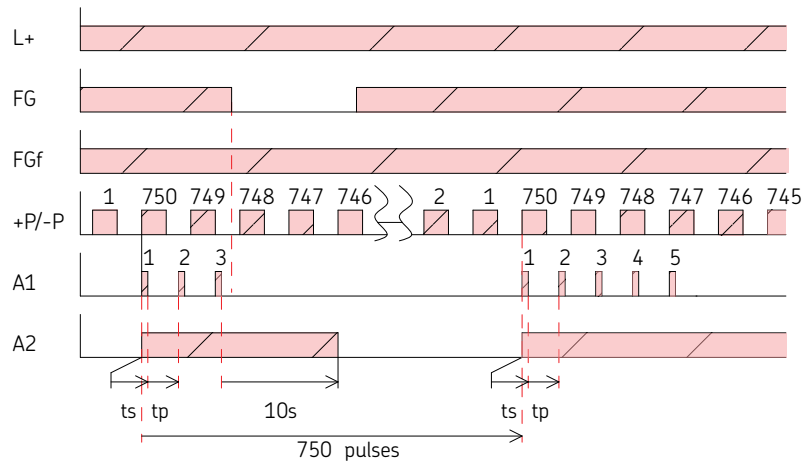

Setting example:

Setting	Typ	Function	Adjusting table (see pages 50-51)
Operating mode:		Distance-dependent	A
Rotary switch S9 (curve sensor deactivated):		0	F
Lubrication period duration T:		750 pulses	E
Number of lubrication pulses (burst); output A1:		5	C
Lubrication interval time tp, output A1:	LCG2-A04	1 s or 2 s	B
	LCG2-A07	2 s or 4 s	B
	LCG2-A08	2.5 s or 2 s	B

Legend to Fig. 4.12

Abbreviation Legend

L+	Operating voltage
FG	Enable input
FGf	Enable frequency (internal signal: pulse frequency at input +P/-P is > 3.5 Hz)
+P/-P	Input for distance-dependent pulses
A1	Output for electromagnetic pump
A2	Output for lubricant pump
ts	Lubrication pulse time (0.2 s non-adjustable)
tp	Lubrication interval time
tv	Lubricant pump; switch-off delay time (10 s non-adjustable)
T	Lubrication period duration in number of distance-dependent pulses

Settings made according to adjusting tables: Chapter 6.2.5, pages 50 to 51.

4.7 Functions of pushbutton DK

The functions on the built-in pushbutton and the externally connectable pushbutton DK are identical and can be accessed even without lubrication enable conditions. Note the duration of pushbutton actuation. The functions start

once the button is released. The program automatically returns to normal operation after the triggered function is complete.

4.7.1 Functional diagrams of the pushbutton

The following pages contain functional diagrams of the pushbutton DK for illustrative purposes.



The figures are not true to scale.

Pushbutton functions, Table 7

DK- Actuation duration	Series LCG2 - A04 / Serie LCG2 - A07		Series LCG2 - A08	
	Condition	Function triggered	Condition	Function triggered
< 3s	In normal operation but not during a lubrication pulse or a venting operation that may have been started.	<ul style="list-style-type: none"> Starts a lubrication pulse 1) Starts a lubrication pump cycle of 10 s. <p>1) Only one pulse is triggered regardless of the settings for DIP switches S3 / S4</p>	In normal operation but not during a lubrication pulse or a venting operation that may have been started.	<ul style="list-style-type: none"> Starts a lubrication pump cycle with a delay time of 10 s Starts a lubrication pump cycle according to the setting of DIP switches S3 & S4
> 3s		Starts a lubricant pump cycle of 60 s (for example to vent the lubricant line during commissioning).		Triggers 10 successive lubrication pulses with the interval time set by DIP switch S2.
< 3s	During a venting operation (lubricant pump cycle of 60 s)	Lubricant pump cycle is stopped immediately.	During a lubrication pulse triggered by pressing DK >3 s.	Immediately returns to normal operation.

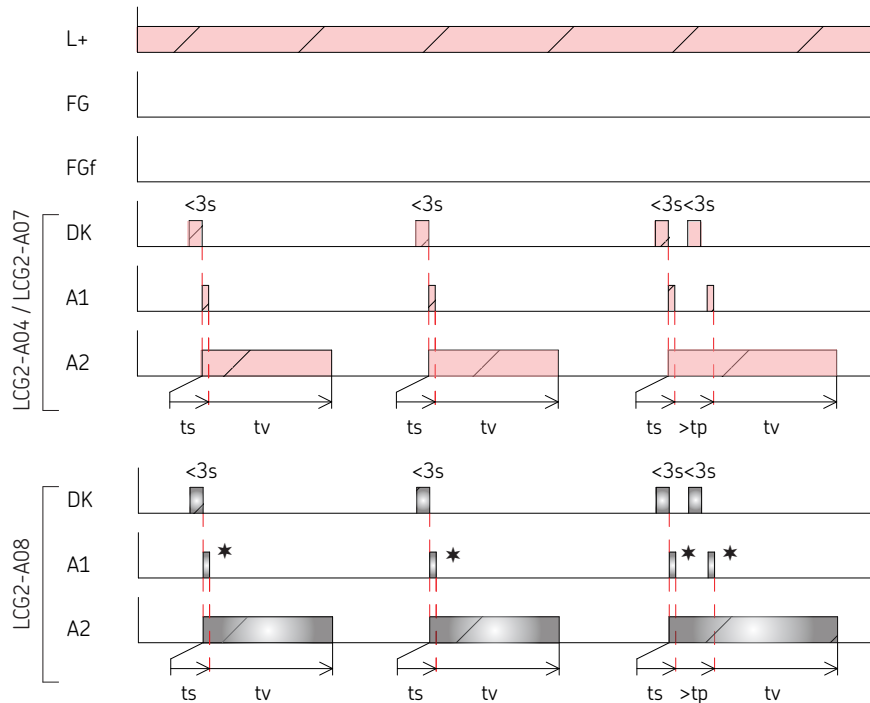
Pushbutton actuation time $t_{DK} < 3$ s (lubrication test function), Fig. 4.13

Legend to Fig. 4.13

Abbreviation Legend

L+	Operating voltage
FG	Enable input
FGf	Enable frequency (internal signal: pulse frequency at input +P/-P is > 3.5 Hz)
+P/-P	Input for distance-dependent pulses
A1	Output for electromagnetic pump
A2	Output for lubricant pump
t_s	Lubrication pulse time (0.2 s non-adjustable)
t_p	Lubrication interval time
t_v	Lubricant pump; switch-off delay time (10 s non-adjustable)

LCG2-A08

*	Number of pulses depends on setting of DIP switches S3 and S4
---	---

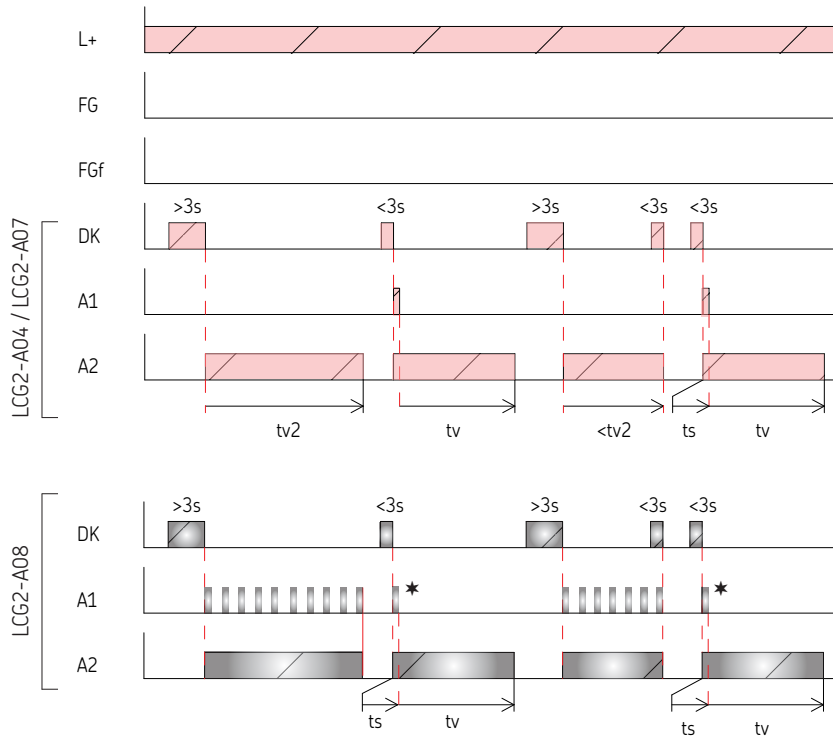
Pushbutton actuation time $t_{DK} > 3\text{ s}$ (venting function), Fig. 4.14

Legend to Fig. 4.14

Abbreviation Legend

L+	Operating voltage
FG	Enable input
FGf	Enable frequency (internal signal: pulse frequency at input +P/-P is $> 3.5\text{ Hz}$)
+P/-P	Input for distance-dependent pulses
A1	Output for electromagnetic pump
A2	Output for lubricant pump
t_s	Lubrication pulse time (0.2 s non-adjustable)
t_p	Lubrication interval time
t_v	Lubricant pump; switch-off delay time (10 s non-adjustable)
tv_2	Lubricant pump; runtime (60 s non-adjustable)

LCG2-A08

- ★ Number of pulses depends on setting of DIP switches S3 and S4

4.8 Setting the lubrication interval time t_p

Lubrication interval time t_p is set using DIP switch S2 (see Table B) and applies to the following times:

- Interval time between multiple consecutive lubrication pulses when using curve-dependent lubrication
- Interval time between lubrication pulses executed in short succession during a lubrication operation when using time- or distance-dependent lubrication.
- Setting lubrication interval time t_p also defines the minimum lubrication period time for distance-dependent lubrication. An elapsed lubrication operation is always followed by lubrication interval time t_p before a new lubrication operation can be triggered. This ensures that the minimum interval time for pressure relief between lubrication pulses is maintained if, for example, an excessively short distance was

preselected and the vehicle speed and/or distance pulse frequency is too high.

5. Assembly

5.1 General information

Only qualified technical personnel may install, operate, maintain, and repair the curve sensor control unit of series LCG2-A04. Qualified technical personnel are persons who have been trained, assigned, and instructed by the operator of the final product into which the described product is incorporated. Such persons are familiar with the relevant standards, rules, accident prevention regulations, and operating conditions as a result of their training, experience, and instruction. They are qualified to carry out the required activities and in doing so recognize and avoid any potential hazards.

The definition of qualified personnel and the prohibition against employing non-qualified personnel are laid down in DIN VDE 0105 and IEC 364.

Before assembling the curve sensor control units, the packaging material and any shipping braces must be removed. Keep the packaging material until any discrepancies have been resolved.

5.2 Setup and attachment

The curve sensor control unit should be installed in a place protected from contamination, water splashes, and vibrations. It should be easily accessible so that all further installation work can be performed without difficulty and the control unit can be configured easily later. Avoid installation on vibrating walls or parts.

Installation location pursuant to DIN EN 61373, Appendix C

- Within the vehicle body or an attached roof or underfloor container
- Not on the bogie!

Mounting position

- In any direction on a vertical wall
- Cable glands pointing downwards
- Horizontal installation is also possible if curve-dependent lubrication not be performed.

The following assembly instructions for the bore holes are applicable only if the curve sensor control unit is operated using only one electromagnetic pump or if it is installed outside the associated control cabinet and operates using more than one electromagnetic pump (see 3.3).

See the corresponding drawing for the installation dimensions of the above-mentioned control cabinet. The electrical connection is then established not according to Fig. 7 but rather to the terminal diagram for the control cabinet. If present, other installation instructions must be followed.

Further, design specifications and conditions of the railway vehicle manufacturer and the object must be observed.

During assembly and especially when drilling, always pay attention to the following:

- Ensure sufficient clearance under the device for subsequent laying of electrical lines. The minimum bending radii of the lines according to the manufacturer's speci

fications must be observed while doing so.

- Also ensure sufficient clearance for manual actuation in the area of the DK pushbutton.
- Existing supply lines must not be damaged by assembly work.
- Other units must not be damaged by assembly work.
- The product must not be installed within range of moving parts.
- The product must be installed at an adequate distance from sources of heat.

Electrical installation

- The rules for railway applications pursuant to DIN EN 50343 must be observed during installation of the electrical lines.
- Flexible electrical installation pipes as well as cables and lines must be laid in such a way that fluids flow away from the screw unions.



Note!

When establishing the curve sensor control unit's electrical connection, ensure that appropriate measures prevent interference between signals due to inductive, capacitive, or electro-magnetic couplings.

Shielded cables must be used in places where electrical interference fields can distort signal transmissions despite separate laying of cables.

The rules and empirical values for "EMC-compliant" cabling must be taken into consideration.

5.3 Assembly of the LCG2-A04/LCG2-A07/ LCG2-A08 curve sensor control unit

☞ See Figure 5 on the following page.

5.3.1 Mounting equipment

The curve sensor control unit is secured to the intended installation location on the railway vehicle using hexagon socket screws. Fastening material to be provided by the customer:

Example:

- Hexagon socket screws per:
DIN912-M4 -8.8 (2x)
- If necessary, washers (4x) per:
DIN 125-B4.3-St (2x)
- If necessary, self-locking hexagon nuts
DIN985-M4-8 (2x)
- Drill assembly holes on the installation location according to Figure 5; deburr and grind the assembly holes

- Unscrew the cover screws (4x) on the cover of the curve sensor control unit using a screwdriver (Philips) and place them aside together with the cover.



Note!

The curve sensor control units contain electronic components that can be destroyed by accidental electrostatic charge or discharge (ESD). To prevent possible damage due to ESD, hands and any tools must be discharged on a bare grounded position on the railway vehicle prior to performing any work in the area of the printed circuit board. Conductors or component connections within the device must not be touched under any circumstances.

- Pass fixing screws through the fixing holes in the control unit's housing and mounting location; if necessary, gently tighten the washers and self-locking nuts gently

- Align the control unit housing



Note!

Make sure that torque is adequate when installing the curve sensor control unit!

- Securely tighten the hexagon socket screws

5.3.2 Mounting diagram for LCG2-A04, LCG2-A07 and LCG2-A08

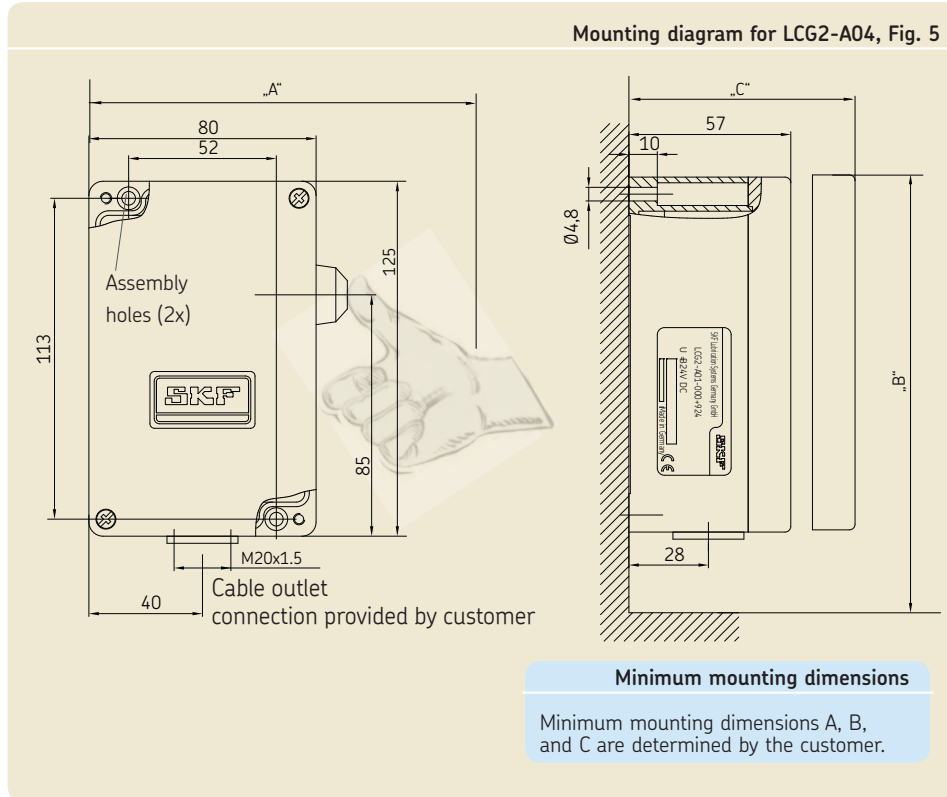

5.4 Electrical connection



Danger!

The available mains voltage (supply voltage) must be in accordance with the specifications on the rating plate of the curve sensor control unit. Does LCG2-A04 control unit include equipment protection. The customer must install line protection that is suitable for the conductor cross-section and length, the power consumption of the control unit, and possible short-circuit current. Incorrect sizing may result in bodily injury and property damage.

- Draw connecting lines (provided by customer) into the cable glands and wire according to the terminal diagram (Fig. 7)

5.4.1 Electrical connection example for LCG2-A04/LCG2-A07

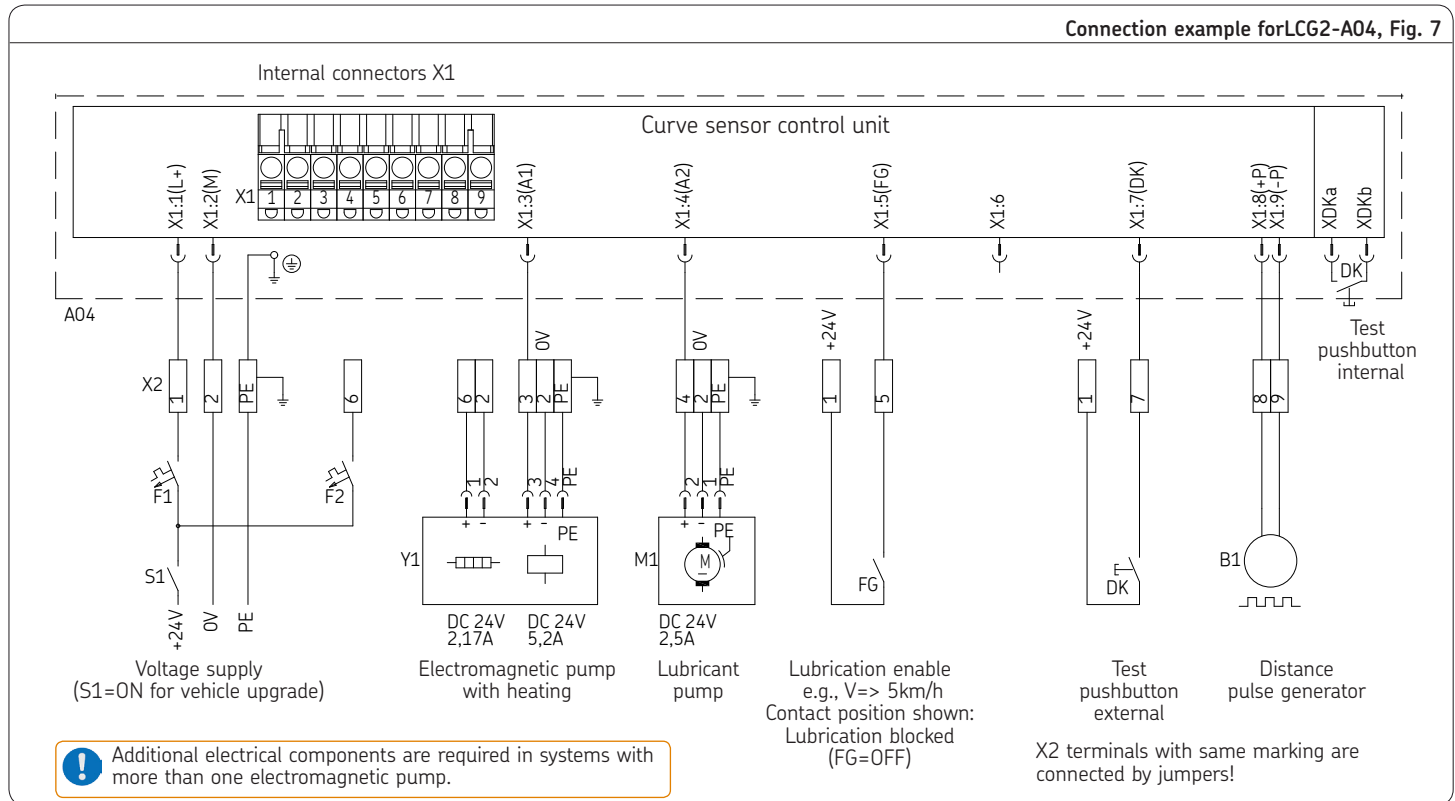

Connection diagram for LCG2-A04/ LCG2-A07, legend to Fig. 7

Designation	Description	Function
A1	Curve sensor control unit LCG2-A04...	Lubrication control (see 4.2)
X1:1 to X1:9	Connector on circuit board (9-pin)	Electrical control unit connection
X2	Terminal block on vehicle	Distributor
F1	Fuse, operating voltage A1	Overcurrent protective device
F2	Fuse, heater circuit of Y1	Overcurrent protective device
S1	Switching contact for operating voltage	Voltage supply, S1 = ON for vehicle upgrade, power supply DC 24V, 10A
Y1	Electromagnetic pump with heating	Lubrication pulse output (see 4.3, 4.5, and 4.6)
M1	Lubricant pump	Supply of lubricant to electromagnetic pump Y1 (see 3.4 and 4.2.1)
FG	Switching contact on vehicle for, Lubrication enable	e.g., switching signal for vehicle speed $v > 5$ km/h. Contact position shown: lubrication blocked (FG = OFF)
DK	Pushbutton (on control unit and external)	Manual triggering of lubrication pulse output and venting of lubricant line (see 4.7)
B1	Pulse generator on vehicle	Sends distance-proportional pulses which are counted by the curve sensor control unit (used only with distance-dependent lubrication)

5.4.2 Customer connection

Components of control unit, Fig. 6

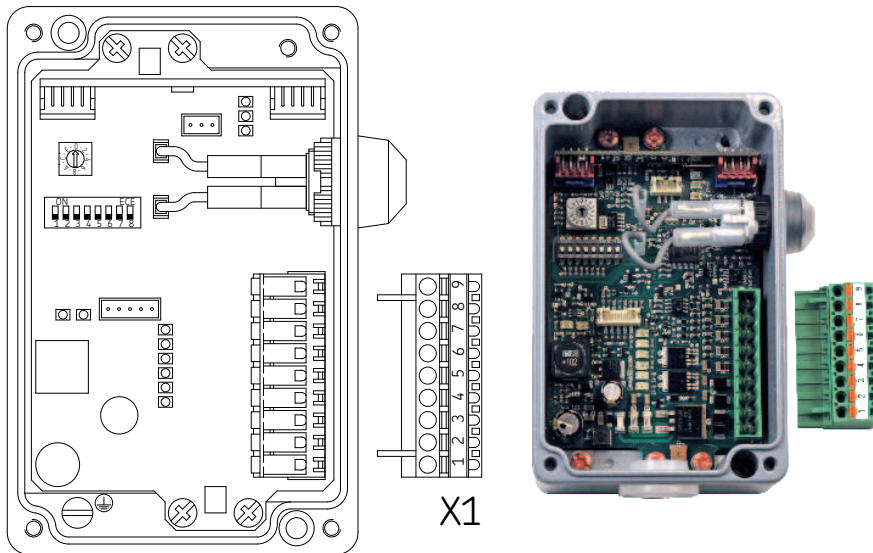

Assignments on terminal strip X1

Item	Description
	⊖ PE conductor input
1	L+ Operating voltage supply
2	M- Minus input (0V)
3	A1 Output 1 for lubrication pulse (electromagnetic pump)
4	A2 Output 2 for lubricant pump
5	FG Lubrication enable input
6	No function
7	DK Connection of an external pushbutton DK for lubrication pulse triggering
8	+P Pulse input, positive potential, optically isolated from operating voltage potential ¹⁾
9	-P Pulse input, negative potential, optically isolated from operating voltage potential ¹⁾

1) Inputs +P/-P are used only for distance-dependent lubrication.

6. Operation

6.1 Adjustment elements of the LCG2-A04, LCG2-A07 and LCG2-A08 curve sensor control unit

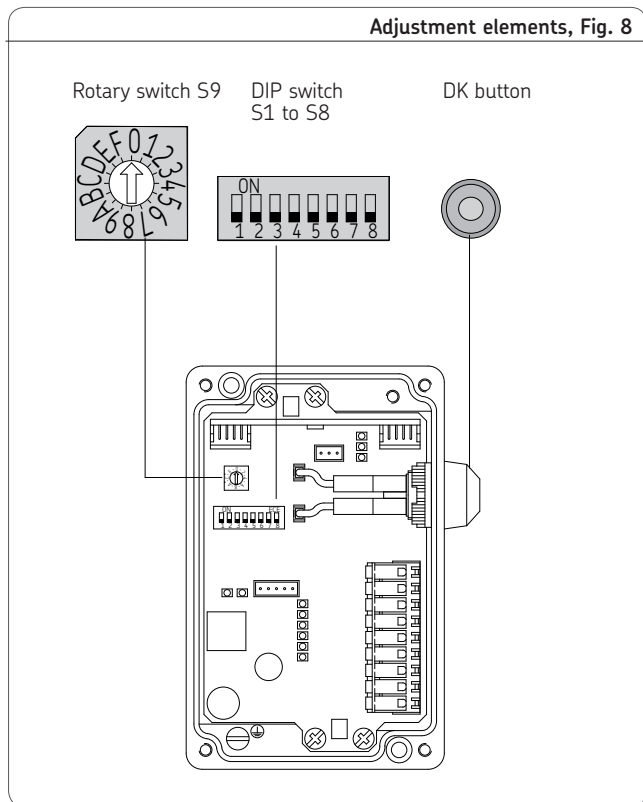

Legend to Fig. 8

Rotary switch S9

Deactivation, activation, and sensitivity setting of curve sensor

DIP switches S1 to S8

Setting for operating mode and other functional parameters

- S1** - Preselects time- or distance-dependent lubrication
- S2** - Interval time t_p between successive lubrication pulses
- S3 to S4** - Sets the number of successive lubrication pulses per lubrication cycle when using time- or distance-dependent lubrication
- S5 to S8** - Deactivates or activates operating mode preselected with S1 by configuring the lubrication period duration for time- or distance-dependent lubrication

Pushbutton DK

- see function table 7, page 34

Adjustment elements, Fig. 9

DIP switches S1 to S8
for setting the operating mode
and other functional parameters

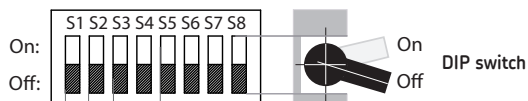

For settings, see **Table D/E**

For settings, see **Table C**

For settings, see **Table B**

For settings, see **Table A**

For settings, see **Table F**

Rotary switch S9

Table E - Lubrication period duration in number of distance pulses (S1 = ON)
or:
Table D - Lubrication period time in seconds (S1 = OFF)

Number of lubrication pulses triggered successively per lubrication cycle when using time- or distance-dependent lubrication

Interval time t_p between successive lubrication pulses

Switch operating modes:

- Time-dependent lubrication (S1 = OFF)
- Distance-dependent lubrication (S1 = ON)

Deactivation, activation, and sensitivity setting of curve sensor
Deactivation: rotary switch position "0" (factory setting)



Note!

Set parameters only on de-energized equipment.

6.2 Operating modes of the LCG2-A04/ LCG2-A07 and LCG2-A08 curve sensor control unit

6.2.1 Curve sensor sensitivity

The procedure for determining curve sensor sensitivity is identical in all relevant operating modes.

The sensitivity of the curve sensor can be set to position B (0.73°/s) for commissioning. A test drive with different settings is recommended to determine whether there is a sensitivity more suitable for the existing route profile.

6.2.2 Curve-dependent lubrication



Table cells shaded gray are factory settings.

Table A

Operating mode	DIP switch
	[S1]
Time-dependent lubrication	
Distance-dependent lubrication	

Table C

Number of successive lubrication pulses per lubrication period T	DIP-switch		
	[S3]	[S4]	
LCG2-A04 LCG2-A07 LCG2-A08	2		
LCG2-A04 LCG2-A07 LCG2-A08	3		
LCG2-A04 LCG2-A07 LCG2-A08	4		
LCG2-A04 LCG2-A07 LCG2-A08	5		
LCG2-A04 LCG2-A07 LCG2-A08	1		

Table B

Interval times between successive lubrication pulses tp [s]	LCG2-A04	Interval times between successive lubrication pulses tp [s]	LCG2-A07	Interval times between successive lubrication pulses tp [s]	LCG2-A08
	DIP switch [S2]		DIP switch [S2]		DIP switch [S2]
1,0		2,0		2,5	
2,0		4,0		2,0	

Table D

Lubrication period time (time-dependent lubrication) T [s]	DIP switch			
	[S5]	[S6]	[S7]	[S8]
OFF (factory setting)	<input type="checkbox"/>	<input type="checkbox"/>	<input type="checkbox"/>	<input type="checkbox"/>

Table F

Curve sensitivity [degrees/s]	Rotary switch [Switch position]
Curve sensor deactivated	0
1.90	1
1.73	2
1.57	3
1.43	4
1.30	5
1.18	6
1.07	7
0.98	8
0.89	9
0.81	A
0.73	B
0.67	C
0.61	D
0.55	E
0.50	F

6.2.3 Time-dependent lubrication



Table cells shaded gray are factory settings.

Table A

Operating mode	DIP switch
	[S1]
Time-dependent lubrication	<input type="checkbox"/>
Distance-dependent lubrication	<input type="checkbox"/>

Table C

Number of successive lubrication pulses per lubrication period T	DIP-switch		
	[S3]	[S4]	
LCG2-A04 LCG2-A07 LCG2-A08	2	<input type="checkbox"/>	<input type="checkbox"/>
LCG2-A04 LCG2-A07 LCG2-A08	3	<input type="checkbox"/>	<input type="checkbox"/>
LCG2-A04 LCG2-A07 LCG2-A08	4	<input type="checkbox"/>	<input type="checkbox"/>
LCG2-A04 LCG2-A07 LCG2-A08	5	<input type="checkbox"/>	<input type="checkbox"/>
LCG2-A04 LCG2-A07 LCG2-A08	1	<input type="checkbox"/>	<input type="checkbox"/>

Table B

Interval times between successive lubrication pulses t_p [s]	LCG2-A04	Interval times between successive lubrication pulses t_p [s]	LCG2-A07	Interval times between successive lubrication pulses t_p [s]	LCG2-A08
	DIP switch [S2]		DIP switch [S2]		DIP switch [S2]
1,0	<input type="checkbox"/>	2,0	<input type="checkbox"/>	2,5	<input type="checkbox"/>
2,0	<input type="checkbox"/>	4,0	<input type="checkbox"/>	2,0	<input type="checkbox"/>

Table D

Lubrication period time (time-dependent lubrication) T [s]	DIP switch			
	[S5]	[S6]	[S7]	[S8]
OFF (factory setting)				
20				
25				
32				
40				
50				
64				
80				
100				
130				
160				
200				
250				
312				
390				
488				

Table F

Curve sensitivity [degrees/s]	Rotary switch [Switch position]
Curve sensor deactivated	0

6.2.4 Time- and curve-dependent lubrication



Table cells shaded gray are factory settings.

Table A

Operating mode	DIP switch
	[S1]
Time-dependent lubrication	<input type="checkbox"/>
Distance-dependent lubrication	<input type="checkbox"/>

Table C

Number of successive lubrication pulses per lubrication period T	DIP-switch		
	[S3]	[S4]	
LCG2-A04 LCG2-A07 LCG2-A08	2	<input type="checkbox"/>	<input type="checkbox"/>
LCG2-A04 LCG2-A07 LCG2-A08	3	<input type="checkbox"/>	<input type="checkbox"/>
LCG2-A04 LCG2-A07 LCG2-A08	4	<input type="checkbox"/>	<input type="checkbox"/>
LCG2-A04 LCG2-A07 LCG2-A08	5	<input type="checkbox"/>	<input type="checkbox"/>
LCG2-A04 LCG2-A07 LCG2-A08	1	<input type="checkbox"/>	<input type="checkbox"/>

Table B

Interval times between successive lubrication pulses t_p [s]	LCG2-A04	Interval times between successive lubrication pulses t_p [s]	LCG2-A07	Interval times between successive lubrication pulses t_p [s]	LCG2-A08
	DIP switch [S2]		DIP switch [S2]		DIP switch [S2]
1,0	<input type="checkbox"/>	2,0	<input type="checkbox"/>	2,5	<input type="checkbox"/>
2,0	<input type="checkbox"/>	4,0	<input type="checkbox"/>	2,0	<input type="checkbox"/>

Table D

Lubrication period time (time-dependent lubrication) T [s]	DIP switch			
	[S5]	[S6]	[S7]	[S8]
OFF (factory setting)				
20				
25				
32				
40				
50				
64				
80				
100				
130				
160				
200				
250				
312				
390				
488				

Table F

Curve sensitivity (degrees/s)	Rotary switch [Switch position]
Curve sensor deactivated	0
1.90	1
1.73	2
1.57	3
1.43	4
1.30	5
1.18	6
1.08	7
0.98	8
0.89	9
0.81	A
0.73	B
0.67	C
0.61	D
0.55	E
0.50	F

6.2.5 Distance-dependent lubrication



Table cells shaded gray are factory settings.

Table A

Operating mode	DIP switch
	[S1]
Time-dependent lubrication	☐
Distance-dependent lubrication	☑

Table C

Number of successive lubrication pulses per lubrication period T	DIP-switch	
	[S3]	[S4]
LCG2-A04	☑	☑
LCG2-A07	☑	☑
LCG2-A08	☑	☑
LCG2-A04	☑	☑
LCG2-A07	☑	☑
LCG2-A08	☑	☑

Table B

Interval times between successive lubrication pulses t_p [s]	LCG2-A04	Interval times between successive lubrication pulses t_p [s]	LCG2-A07	Interval times between successive lubrication pulses t_p [s]	LCG2-A08
	DIP switch [S2]		DIP switch [S2]		DIP switch [S2]
1,0	☑	2,0	☑	2,5	☑
2,0	☑	4,0	☑	2,0	☑

Table E

Lubrication period duration (distance-dependent lubrication) T [pulses]	DIP switch			
	[S5]	[S6]	[S7]	[S8]
OFF (factory setting)	<input type="checkbox"/>	<input type="checkbox"/>	<input type="checkbox"/>	<input type="checkbox"/>
500	<input type="checkbox"/>	<input type="checkbox"/>	<input type="checkbox"/>	<input type="checkbox"/>
750	<input type="checkbox"/>	<input type="checkbox"/>	<input type="checkbox"/>	<input type="checkbox"/>
1125	<input type="checkbox"/>	<input type="checkbox"/>	<input type="checkbox"/>	<input type="checkbox"/>
1700	<input type="checkbox"/>	<input type="checkbox"/>	<input type="checkbox"/>	<input type="checkbox"/>
2125	<input type="checkbox"/>	<input type="checkbox"/>	<input type="checkbox"/>	<input type="checkbox"/>
3200	<input type="checkbox"/>	<input type="checkbox"/>	<input type="checkbox"/>	<input type="checkbox"/>
4800	<input type="checkbox"/>	<input type="checkbox"/>	<input type="checkbox"/>	<input type="checkbox"/>
7200	<input type="checkbox"/>	<input type="checkbox"/>	<input type="checkbox"/>	<input type="checkbox"/>
10800	<input type="checkbox"/>	<input type="checkbox"/>	<input type="checkbox"/>	<input type="checkbox"/>
16200	<input type="checkbox"/>	<input type="checkbox"/>	<input type="checkbox"/>	<input type="checkbox"/>
24300	<input type="checkbox"/>	<input type="checkbox"/>	<input type="checkbox"/>	<input type="checkbox"/>
36450	<input type="checkbox"/>	<input type="checkbox"/>	<input type="checkbox"/>	<input type="checkbox"/>
54675	<input type="checkbox"/>	<input type="checkbox"/>	<input type="checkbox"/>	<input type="checkbox"/>
82000	<input type="checkbox"/>	<input type="checkbox"/>	<input type="checkbox"/>	<input type="checkbox"/>
123000	<input type="checkbox"/>	<input type="checkbox"/>	<input type="checkbox"/>	<input type="checkbox"/>

Table F

Curve sensitivity [degrees/s]	Rotary switch [Switch position]
Curve sensor deactivated	0

6.2.6 Distance- and curve-dependent lubrication



Table cells shaded gray are factory settings.

Table A

Operating mode	DIP switch
	[S1]
Time-dependent lubrication	<input type="checkbox"/>
Distance-dependent lubrication	<input type="checkbox"/>

Table C

Number of successive lubrication pulses per lubrication period T	DIP-switch		
	[S3]	[S4]	
LCG2-A04 LCG2-A07 LCG2-A08	2	<input type="checkbox"/>	<input type="checkbox"/>
LCG2-A04 LCG2-A07 LCG2-A08	3	<input type="checkbox"/>	<input type="checkbox"/>
LCG2-A04 LCG2-A07 LCG2-A08	4	<input type="checkbox"/>	<input type="checkbox"/>
LCG2-A04 LCG2-A07 LCG2-A08	5	<input type="checkbox"/>	<input type="checkbox"/>
LCG2-A04 LCG2-A07 LCG2-A08	1	<input type="checkbox"/>	<input type="checkbox"/>

Table B

Interval times between successive lubrication pulses t_p [s]	LCG2-A04	Interval times between successive lubrication pulses t_p [s]	LCG2-A07	Interval times between successive lubrication pulses t_p [s]	LCG2-A08
	DIP switch [S2]		DIP switch [S2]		DIP switch [S2]
1,0	<input type="checkbox"/>	2,0	<input type="checkbox"/>	2,5	<input type="checkbox"/>
2,0	<input type="checkbox"/>	4,0	<input type="checkbox"/>	2,0	<input type="checkbox"/>

Table E

Lubrication period duration (distance-dependent lubrication) T [pulses]	DIP switch			
	[S5]	[S6]	[S7]	[S8]
OFF (factory setting)	<input type="checkbox"/>	<input type="checkbox"/>	<input type="checkbox"/>	<input type="checkbox"/>
500	<input type="checkbox"/>	<input type="checkbox"/>	<input type="checkbox"/>	<input type="checkbox"/>
750	<input type="checkbox"/>	<input type="checkbox"/>	<input type="checkbox"/>	<input type="checkbox"/>
1125	<input type="checkbox"/>	<input type="checkbox"/>	<input type="checkbox"/>	<input type="checkbox"/>
1700	<input type="checkbox"/>	<input type="checkbox"/>	<input type="checkbox"/>	<input type="checkbox"/>
2125	<input type="checkbox"/>	<input type="checkbox"/>	<input type="checkbox"/>	<input type="checkbox"/>
3200	<input type="checkbox"/>	<input type="checkbox"/>	<input type="checkbox"/>	<input type="checkbox"/>
4800	<input type="checkbox"/>	<input type="checkbox"/>	<input type="checkbox"/>	<input type="checkbox"/>
7200	<input type="checkbox"/>	<input type="checkbox"/>	<input type="checkbox"/>	<input type="checkbox"/>
10800	<input type="checkbox"/>	<input type="checkbox"/>	<input type="checkbox"/>	<input type="checkbox"/>
16200	<input type="checkbox"/>	<input type="checkbox"/>	<input type="checkbox"/>	<input type="checkbox"/>
24300	<input type="checkbox"/>	<input type="checkbox"/>	<input type="checkbox"/>	<input type="checkbox"/>
36450	<input type="checkbox"/>	<input type="checkbox"/>	<input type="checkbox"/>	<input type="checkbox"/>
54675	<input type="checkbox"/>	<input type="checkbox"/>	<input type="checkbox"/>	<input type="checkbox"/>
82000	<input type="checkbox"/>	<input type="checkbox"/>	<input type="checkbox"/>	<input type="checkbox"/>
123000	<input type="checkbox"/>	<input type="checkbox"/>	<input type="checkbox"/>	<input type="checkbox"/>

Table F

Curve sensitivity [degrees/s]	Rotary switch [Switch position]
Curve sensor deactivated	0
1.90	1
1.73	2
1.57	3
1.43	4
1.30	5
1.18	6
1.08	7
0.96	8
0.89	9
0.81	A
0.73	B
0.67	C
0.61	D
0.55	E
0.50	F

7. Commissioning

7.1 Commissioning procedure

Inspect all electrical connections before commissioning the product.

Commissioning

Prior to commissioning, the centralized lubrication system must be vented as described in its operating instructions. In this process, check the function of the LCG2-A04 curve sensor control unit using pushbutton DK (see Chapter 4.7).

The sensitivity of the curve sensor can be set to position B (0.73°/s) (factory setting) for commissioning.

A test drive with different settings is recommended to determine whether there is a sensitivity more suitable for the existing route profile.

8. Shutdown and disposal

8.1 Temporary shutdown

The described product can be temporarily shut down by disconnecting the electrical supply connections. The safety instructions in the operating instructions must be observed when doing so. If the product will be shut down for an extended period of time, the instructions in Chapter 2, "Transport and storage," must be observed.

To recommission the product, follow the safety instructions in Chapter 2 and the information on changing parameters in Chapter 6.

8.2 Permanent shutdown

If the product will be permanently shut down, the local regulations and laws regarding the disposal of contaminated equipment must be observed.



Note!



Electronic components can contaminate soil and waterways!
Observe the local regulations and laws regarding the disposal of lubricants.

The product can also be returned to SKF Lubrication Systems Germany GmbH for disposal, in which case the customer is responsible for reimbursing the costs incurred.

The parts are recyclable.

9. Maintenance and service



Danger!

Performing work on products that have not been de-energized may result in serious injury or death. Assembly, maintenance, and repair work may only be performed on products that have been de-energized by qualified technical personnel. Supply voltage must be switched off before opening any of the product's components.

If necessary, a protective earth connection must be established prior to starting work.



Note!

The curve sensor control units contain electronic components that can be destroyed by accidental electrostatic charge or discharge (ESD). To prevent possible damage due to ESD, hands and any tools must be discharged on a bare grounded position on the railway vehicle prior to performing any work in the area of the printed circuit board. Conductors or component connections within the device must not be touched

under any circumstances.

SKF Lubrication Systems Germany GmbH products are low-maintenance. However, you should inspect the following items at regular intervals to ensure proper function.

- No visible damage
- Housing securely affixed to the wall
- Cover tightly closed
- All cables securely attached
- Secure hold on strain relief for cables / cable harnesses
- Corrosion or traces of fire
- Functional check using pushbutton DK with visual control of the grease pattern, e.g., at the wheel flange lubrication point



Dismantling of individual parts of the product is not permitted and voids any claims.



Only original spare parts from SKF Lubrication Systems Germany GmbH may be used. Unauthorized alterations to the product and the use of non-original spare parts and accessories are prohibited and nullify the statutory warranty.

SKF Lubrication Systems Germany GmbH shall not be held liable for damages resulting from improperly performed assembly, maintenance or repair work on the product.

If you encounter problems or have any questions, please contact our sales and service centers or our representatives abroad. A list with current addresses is available on the Internet at:

www.skf.com/lubrication

10. Operational malfunctions

10.1 General

The following table provides an overview of possible malfunctions and their causes. If you cannot remedy the malfunction, the curve sensor control unit needs to be replaced; you may also contact the Service department of SKF Lubrication Systems Germany GmbH.



Dismantling of individual parts of the product within the warranty period is not permitted and voids any claims.



Note!

All actions such as repairs, part replacement, etc. may only be performed by qualified and trained personnel.



Danger!

All repair or maintenance work must be performed in a voltage-free state. If necessary, a protective earth connection must be established prior to starting work.



Note!

The curve sensor control units contain electronic components that can be destroyed by accidental electrostatic charge or discharge (ESD). To prevent possible damage due to ESD, hands and any tools must be discharged on a bare grounded position on the railway vehicle prior to performing any work in the area of the printed circuit board. Conductors or component connections within the device must not be touched under any circumstances.

10.2 Troubleshooting

The main circuit board of the curve sensor control unit is equipped with LEDs which are assigned to the inputs and outputs (among other connections) and allow for quick inspection in case of malfunctions. If errors occur, first remove the device cover to localize a possible malfunction using the corresponding LEDs (see the LED functions in Chapter 4.1 for LCG2-A04).

Fault analysis and rectification

Fault	Possible cause	Remedy
No lubrication occurs when pushbutton DK is actuated; operating voltage is connected.	o Connection of electromagnetic pump is defective	● Inspect connection
	o Electromagnetic pump is defective	● Replace electromagnetic pump
	o Short-circuit in electromagnetic pump circuit	● Remedy short-circuit
	o Pushbutton is defective	● Check pushbutton, replace if necessary
The control unit does not always respond to actuation of pushbutton DK	o Lubrication interval time t_p has not ended since the most recent lubrication time	● Wait for lubrication interval time t_p to end and then actuate pushbutton DK again
	Lubrication occurs when pushbutton DK is actuated but no lubricant discharges from the spray nozzle	o Lubricant lines are not completely filled with lubricant
o Supply of lubricant is depleted		● Refill lubricant

Fault analysis and rectification

Fault	Possible cause	Remedy
Curve-dependent lubrication is not performed	o Curve sensor is not activated (rotary switch in position 0)	● Switch rotary switch for curve sensor to position > 0 (-see Chapter 6.2, Table F)
	o The curve sensor's sensitivity is set too low	● Increase sensitivity of the curve sensor (-see Chapter 6.2, Table F)
	o Lubrication enable signal is not activated on input FG	● Check whether the lubrication enable signal on input FG is functioning properly
	o When DIP switch S1 is to set to ON, the lubrication enable frequency of ≥ 3.5 Hz on distance pulse input +P/-P was not reached	● DIP switch S1 only has to be in the ON position when using the distance-dependent lubrication function; otherwise, switch DIP switch S1 to the OFF position
	o Vehicle is traveling too slowly for the set curve sensor sensitivity or the curve radius is too large	● Readjust the sensitivity

Fault analysis and rectification

Fault	Possible cause	Remedy
Time-dependent lubrication is not performed	o The time-dependent lubrication function is not pre-selected (DIP switch S1 in ON position) and/or is not activated (DIP switches S5 to S8 in OFF position)	● Preselect the time-dependent lubrication function (switch DIP switch S1 to the OFF position) and activate it (switch DIP switches S5 to S8 to the ON position according to Table D) (see Chapter 6.2.3, Table D)
	o Lubrication enable signal is not activated on input FG	● Check whether the lubrication enable signal on input FG is functioning properly (see 4.5.3)
Distance-dependent lubrication is not performed	o The distance-dependent lubrication function is not preselected (DIP switch S1 in OFF position) and/or is not activated (DIP switches S5 to S8 in OFF position)	● Preselect the distance-dependent lubrication function (switch DIP switch S1 to the ON position) and activate it (switch DIP switches S5 to S8 to the ON position according to Table E) (see Chapter 6.2.5, Table E)
	o Lubrication enable signal is not activated on input FG	● Check whether the lubrication enable signal on input FG is functioning properly (see Chapter 4.6.3)
	o The lubrication enable frequency of ≥ 3.5 Hz on distance pulse input +P/-P was not reached	● Check whether pulses are being received on distance pulse input +P/-P and the lubrication enable frequency is reached (see Chapter 4.1, LED for lubrication enable frequency, component/item 16)

11. Technical data

11.1 General characteristics

General characteristics

General characteristics - Housing	
Material	Aluminum
Weight	0.50 kg
Dimensions (WxHxD) without cable glands and internal pushbutton DK	(80x125x57) mm
Fixing screws	2x M4
Protection class acc. to DIN EN 60529 (when using suitable cable glands)	IP 65
Mounting position	Vertical, cable gland pointing downwards
Threaded hole for cable gland	M20x1.5 (threaded hole is closed with blanking plug)

Ambient conditions

Temperature class acc. to DIN EN 50155: 2008-03	T1
Working temperature range	-25 °C to 70 °C
Storage temperature range	-40 °C to 85 °C
Air humidity acc. to DIN EN 50125-1:2000-05	Corresponding to temperature class T1
Altitude/air pressure acc. to DIN EN 50125-1:2000-05	Class A2 (up to 1000 m)
Shock and vibration according to DIN EN 61373:2011-04	Category 1, classes A and B

Electrical connection

Connection type	Spring-loaded terminals
Conductor cross-section flexible without/with ferrule	0.5 to 2.5 mm ²
Stripping length of conductors	10 mm

Functional characteristics

Curve sensor sensitivity	Approx. 0.5°/s to 1.9°/s, adjustable in 15 increments
Lubrication period time T for time-dependent lubrication	20 s to 488 s, adjustable in 15 increments

Lubrication period duration T for distance-dependent lubrication	500 to 123000 pulses, adjustable in 15 increments	
Lubrication interval time t_p for curve-dependent lubrication	LCG2-A04 LCG2-A07	1.0 s / 2.0 s
	LCG2-A08	2.0 s / 2.5 s
Lubrication pulse time t_s	0.2 s non-adjustable	
Lubrication interval time t_p for time- or distance-dependent lubrication between successive lubrication pulses on output A1	(as for curve-dependent lubrication)	
	LCG2-A04 LCG2-A07	1.0 s / 2.0 s
	LCG2-A08	2.0 s / 2.5 s
Number of successive lubrication pulses per lubrication period T for time- and distance-dependent lubrication	LCG2-A04 LCG2-A07	2/3/4/5
	LCG2-A08	1/2/3/4

11.2 Electrical characteristics

Electrical characteristics

Power supply L+/M	
Rated voltage U_N	24 VDC
Minimum voltage	$0.7 \times U_N$
Rated operating voltage	$1.15 \times U_N$
Maximum voltage	$1.25 \times U_N$
Standby current consumption @ $1.15 U_N$ (without output load)	Approx. 20 mA
Rated connected load (depends on output load)	Approx. 0.5 W + output load
Device protection	Yes
Reverse voltage protection	Yes
Back-up fuse for line protection	T 6 A

Outputs A1, A2

Switching output	Solid state switch, high-side
Output voltage U_A	Operating voltage minus voltage drop ($U_A = U_B - U_F$)
Voltage drop U_F	Approx. 70 mV @ $I_L = 5 A$
Max. output current (only in intermittent operation)	5 A
Max. output load (only in intermittent operation)	120 W
Overload protection	Yes
Short-circuit protection	Yes

Inputs FG, DK	
Input voltage	24 VDC
Input current	Approx. 8 mA
Input impedance	Approx. 3.3 k Ω
Signal "1" level	≥ 12 V
Signal "0" level	≤ 3 V
Input +P/ -P (optocoupler)	
Voltage range	2 to 30 V
Input current	0.06 mA to 5.0 mA
Input impedance	Approx. 6 k Ω

Signal "1" level	≥ 2 V
Signal "0" level	≤ 1 V
Pulse duty factor	1:1
Max. pulse frequency ¹⁾	2 kHz
Lubrication enable frequency	≥ 3.5 Hz
Standards	
Electronic equipment used on rolling stock	DIN EN 50155

1) The source impedance of the pulse generator must be $R_s \leq 50 \Omega$ in order to comply with the requirements for immunity under DIN EN 50121-3-2.

951-180-063-EN

The contents of this publication are the copyright of the publisher and may not be reproduced in whole or in part without permission of SKF Lubrication Systems Germany GmbH. Every care has been taken to ensure the accuracy of the information contained in this publication. However, no liability can be accepted for any loss or damage, whether direct, indirect, or consequential, arising out of use of the information contained herein.

All SKF products may be used only for their intended purpose as described in these operating instructions with associated operating instructions. If assembly/operating instructions are supplied together with the products, they must be read and followed. Not all lubricants can be fed using centralized lubrication systems. SKF can, on request, inspect the suitability of the lubricant selected by the user for pumping in centralized lubrication systems. Lubrication systems and their components manufactured by SKF are not approved for use in conjunction with gases, liquefied gases, pressurized gases in solution, vapors or such fluids whose vapor pressure exceeds normal atmospheric pressure (1 013 mbar) by more than 0.5 bar at their maximum permissible temperature.

Hazardous materials of any kind, especially the materials classified as hazardous by CLP Regulation EC 1272/2008 may only be used to fill SKF centralized lubrication systems and components and delivered and/or distributed with the same after consulting with and receiving written approval from SKF.

SKF Lubrication Systems Germany GmbH

Motzener Strasse 35/37 · 12277 Berlin · Germany
PO Box 970444 · 12704 Berlin · Germany
Tel. +49 (0)30 72002-0 · Fax +49 (0)30 72002-111
www.skf.com/lubrication

SKF Lubrication Systems Germany GmbH

2. Industriestrasse 4 · 68766 Hockenheim · Germany
Tel. +49 (0)62 05 27-0 · Fax +49 (0)62 05 27-101
www.skf.com/lubrication

