

# High performance S1S hydraulic seals

Providing a longer and more reliable life-cycle for hydraulic cylinders

---



# A leader in sealing technology

Reduced leakage and friction, together with a long and reliable life-cycle. SKF's S1S hydraulic seals create value by reducing the need for maintenance, thereby increasing productivity and profitability.

## S1S – Design and material in perfect harmony

Seals in fluid power applications like hydraulic cylinders must withstand tough operating conditions and high power density demands.

The S1S is a single-acting rod seal made from ECOPUR, an SKF polyurethane compound developed to meet these challenges. It is designed to provide the longest possible maintenance-free service in combination with excellent sealing and leakage performance.

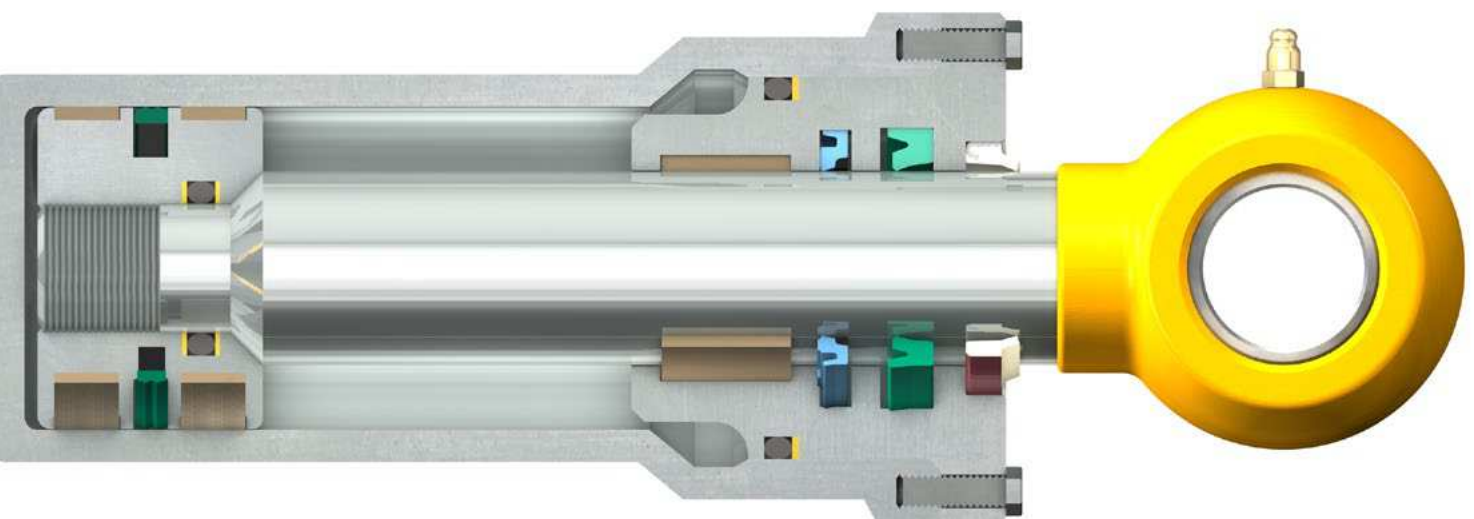
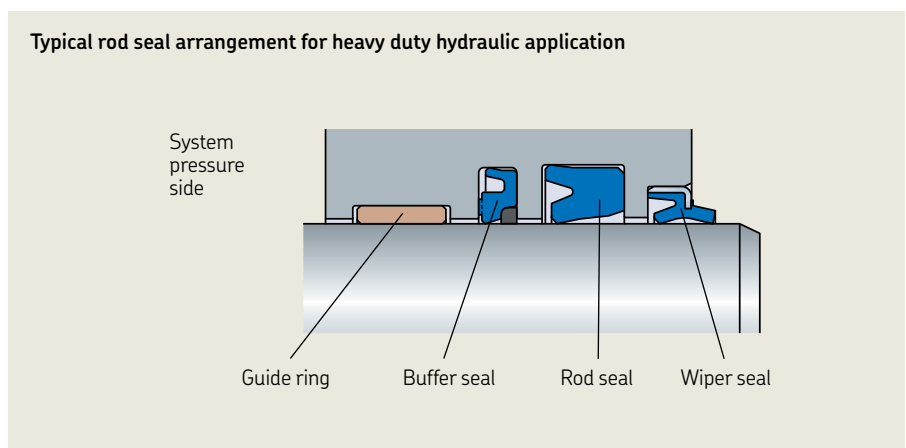

## S1S features deliver top performance

The S1S rod seal has several optimized product features that contribute to its high level of performance:

- U-cup groove geometry is designed to minimize stick-slip phenomena that can lead to erratic cylinder rod motion and noise.
- The premium grade ECOPUR polyurethane provides excellent mechanical properties, high wear resistance and chemical stability in a wide range of medias. This contributes to long seal life.
- The dynamic sealing lip edge is designed and manufactured to provide concentrated primary sealing lip loading. This results in excellent control of the fluid film thickness on the piston rod.
- The dynamic seal surface is designed to have a very smooth transition in the contact force to provide effective fluid back-pumping ability. It also reduces the material stress under higher pressures.
- The premium grade ECOPUR polyurethane and optimized geometric features of the S1S seal combine to make it the most effective single lip rod U-cup available in the market today.

### Temperature range

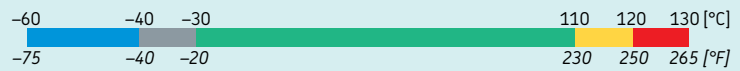

- Extreme low temperature range: may be intermittently exposed (e.g. cold start-up) without seal damage, but seal performance may be compromised while in this range
- Temperatures below the recommended operating range: seal performance depends on system design (precision guiding arrangement recommended)
- **Recommended operating temperature range for this profile and material**
- Temperatures above the recommended operating range: acceptable only with reduced pressure, speed, e-gap and/or with the use of a full-face anti-extrusion ring
- Extreme high temperature range: only occasional short-term exposure (e.g. cylinder in curing oven of a powder coating process)

### Product specifications and temperature range

Material:	ECOPUR (green)
Pressure:	Up to 400 bar (5 800 psi)
Speed:	Up to 1 m/s (3.2 ft/s)
Temperature:	-30 to +110 °C (-20 to +230 °F)
Size Range:	18 – 240 mm
Cylinder classification:	Medium and heavy duty

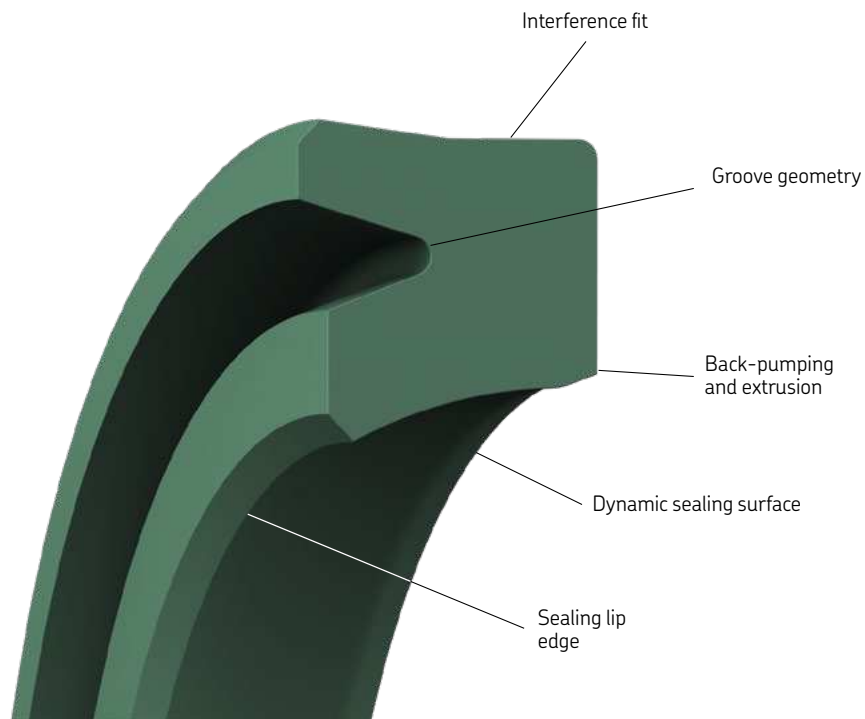

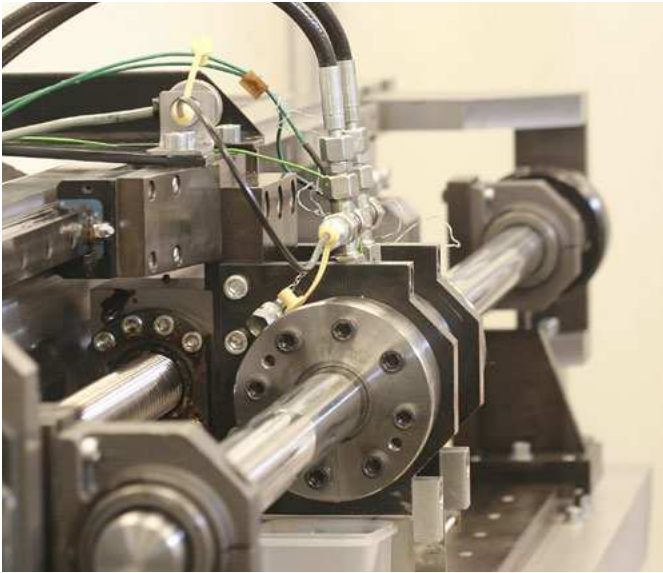

## Rod seal benchmark tests under medium duty conditions

### Testing

To verify that the S1S meets the intended functionality requirements and to validate its performance against similar competitive products, multiple benchmark tests were performed under medium duty and heavy-duty conditions.

The results of the verification testing are shown below with respect to leakage, seal extrusion length and friction force. In all three critical parameters for seal performance, the SKF S1S performed as good as or better than the competitor seals.

Additionally, the test results showed that the preload loss on the outer diameter as well as the lip cross section (which is a combination of compression set and seal wear) were excellent.

#### Leakage

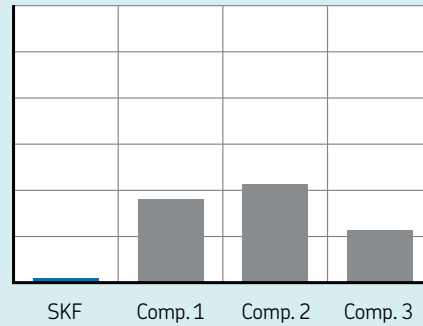

S1S performed best in terms of overall leakage. Competitor 3 is second, but therefore shows drawbacks in terms of friction force and, as a result of this, an increased extrusion length.

#### Extrusion length

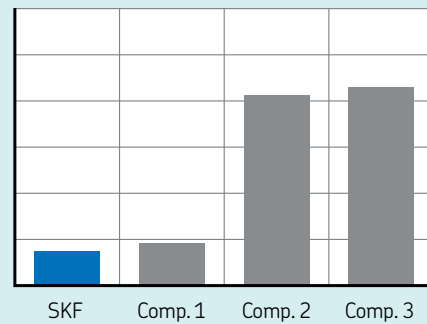

The extrusion performance is a strong indicator of the material performance. S1S is again showing excellent test results, whereas competition 2 and 3 are already showing increased extrusion length.

#### Average friction force

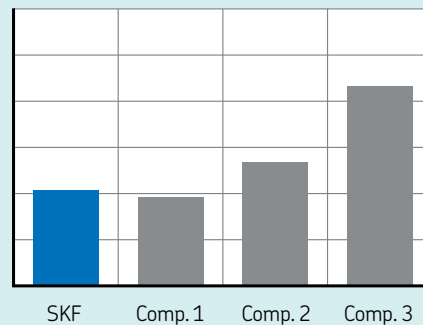

S1S is working on a comparably low friction level in combination with a superior leakage performance, whereas competitor seal 1 already requires a certain leakage to achieve a very similar frictional behaviour. Competitor rod seals 2 and 3 showed increased frictional forces caused by the extrusion length, which again loads the sealing material with higher temperatures.

## A complete offering – from one piece to one million

SKF offer a comprehensive selection of sealing products for extremely demanding applications. Whether you require high quantities for production volumes or a single replacement seal, SKF can meet your product delivery needs. Flexible seal manufacturing capability consists of both moulded and machined processes to accommodate virtually any product demand.

The S1S rod seal is the first of many SKF sealing products that utilises our seamless transfer between manufacturing processes – from a single piece to high volume production. This flexibility delivers quality sealing products that provide maximum value to all customers.

## Manufacturing flexibility

Whether you need a single seal or a high-volume production run, SKF can support your needs. Our flexible seal production model combines moulded and machined manufacturing capabilities to accommodate virtually any demand.

With competencies in compression, injection and transfer moulding technologies, SKF can apply the most appropriate option for your requirements. With the machined seals concept, we are also able to provide machined seals very quickly, without tooling costs.

### Product life cycle stages

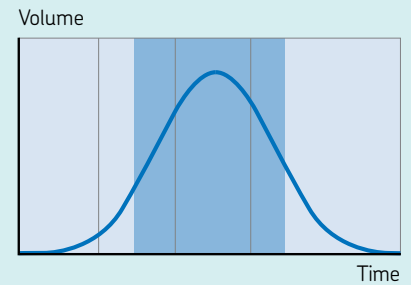

- Machined seals**  
 To cost effectively produce prototypes and seals in low volumes with short delivery time (in the introduction, initial growth, declining phase and to meet replacement demand).
- Moulded seals**  
 To cost effectively produce seals in high volumes (in the growth and maturity phase).

## SKF Research & Development – breakthrough technology

Collaboration between various SKF Research & Development teams results in the latest breakthrough technology being developed, validated and successfully implemented.

The most critical aspect about the SKF R&D department is the interaction between the 5 separate focus areas.

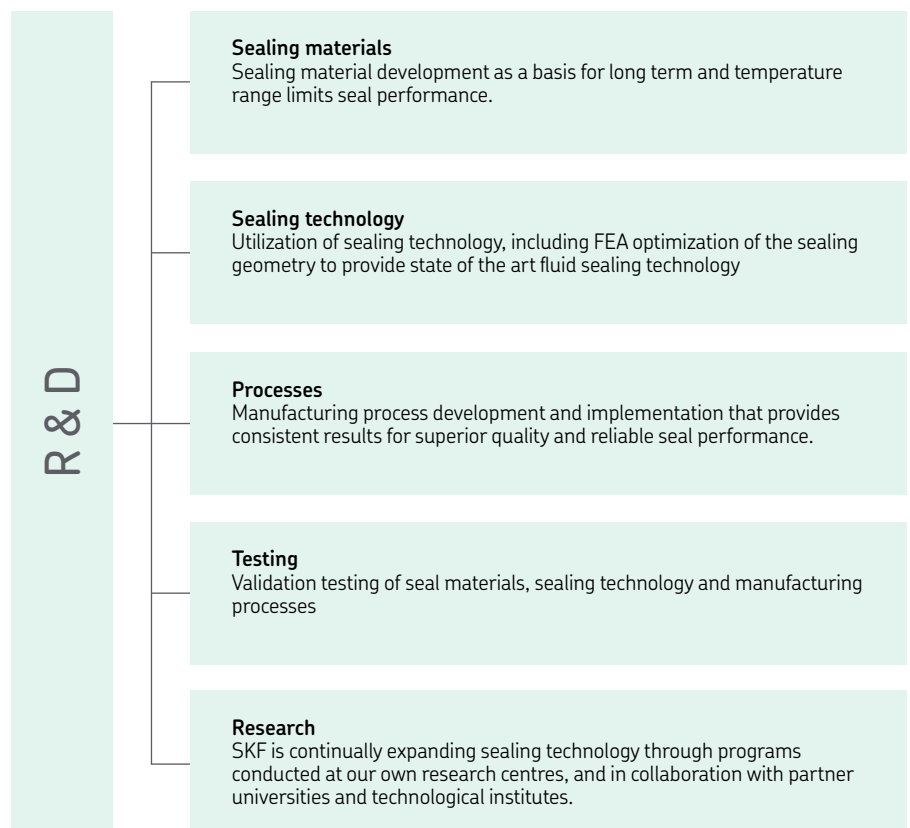



[skf.com/seals](http://skf.com/seals)

© SKF and ECOPUR are registered trademarks of the SKF Group.

© SKF Group 2017

The contents of this publication are the copyright of the publisher and may not be reproduced (even extracts) unless prior written permission is granted. Every care has been taken to ensure the accuracy of the information contained in this publication but no liability can be accepted for any loss or damage whether direct, indirect or consequential arising out of the use of the information contained herein.

PUB SE/P2 16821 EN · March 2017