

CLK lubrication system

SKF ChainLube

Airless oil projection system for conveyor roller chain lubrication

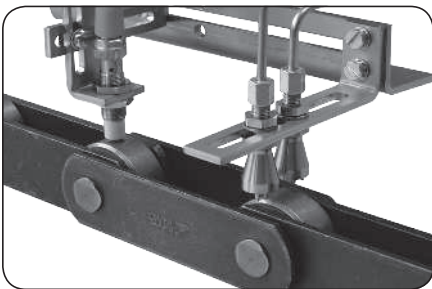

Version	02
Date of issue	November 2014
Publication number	951-130-452
Languages	EN
Country/Countries	EN



Imprint

In accordance with the EU Machine Directive 2006/42/CE, the installation and activation instructions are an integral part of a lubrication system and must be kept close to the equipment for future reference.

The original installation and activation instructions were drafted in compliance with the applicable standards and rules governing technical documentation.

© SKF Lubrication Systems France SAS

This documentation is protected by copyright. All rights reserved. The photomechanical reproduction, copying, and distribution of this documentation or parts thereof by means of processes such as data processing, data carriers, and data networks is strictly prohibited without the express permission of SKF Lubrication Systems France SAS.

Subject to editorial or technical modifications.

Service

For all technical questions, please contact:

SKF Lubrication Systems France SAS
Bld Charles de Gaulle
B.P. 239
37540 St-Cyr-sur-Loire
FRANCE
Tel. +33 (0) 247 405 300
Fax +33 (0) 247 405 353

Or an SKF Service Centre, the addresses of which are given on our website:

www.skf.com/lubrication

Contents

Imprint	3
Service	3
General	5
1 Safety instructions	6
1.1 Intended use	6
1.2 Authorized personnel	6
1.3 Danger relating to electric current	6
1.4 Danger relating to system pressure	6
1.5 Warranty and liability	6
2. Lubricants	7
2.1 General	7
2.2 Selection of lubricants	7
2.3 Approved lubricants	7
2.4 Lubricants and the environment	8
2.5 Danger relating to lubricants	8
3 Construction and operation	9
3.1 General	9
3.2 Versions	9
3.3 Construction	9
3.3 Function	12
4. Installation instructions	12
4.1 Positioning	13
4.2 Installation	14
4.3 Hydraulic connections	17
4.4 Electrical connections	18
5 Transport, delivery and storage	20
5.1 Transport	20
5.2 Delivery	20
5.3 Storage	20
6. Activation	21
6.1 General	21
6.2 Control Unit	21
6.3 Bleeding	24
6.4 Filling with lubricant	25
6.5 Commissioning	25
7. Shutdown	26
7.1 Temporary shutdown	26
7.2 Permanent shutdown	26
8. Maintenance	26
9. Failures	27
10. Technical data	29
11. Spare parts and accessories	30

Information concerning the EC Declaration of Conformity and the EC Declaration of Incorporation

For the product(s) designated below:

Lubrication system, airless oil projection

Product line:

CLK

SKF herewith certifies that it conforms to the pertinent safety requirements set forth in the following Council Directive(s) for the harmonization of the laws of the Member States...

- Machinery Directive **2006/42/EC**
- **IEC 61010-01: 03/2001** Safety compliance
- **IEC 61010-01: 2010** Safety compliance
- **EN 61000-6-4: 2007/A1: 2011** Electromagnetic compatibility (EMC) – Part 6-4 : Generic standards – Emission standard for industrial environments
- **NF EN 60529 (2000)** Degrees of protection provided by enclosures

Note:

- 1 This declaration certifies conformity with the aforementioned directive(s), but does not contain any assurance of properties.
- 2 The safety instructions in the owner's manual must be observed.
- 3 The certified product must not be started up until it is confirmed that the equipment, machinery, vehicle or the like in which the product was installed meets the provisions and requirements of the national directives to be applied.
- 4 Operation of the products on non-standard main voltage as well as nonobservance of installation instructions can affect the EMC properties and electrical safety.

SKF further declares that the above mentioned product:

- is meant for integration into a machinery / for connection to other machinery according to the EC-Machinery Directive 2006/42/EC, Appendix II Part B. Starting up the product is not permissible until it is assured that the machinery, vehicle or the like in which the product was installed meets the provisions and requirements of the regulations set forth in the EC Directive 2006/42/EC.
- with reference to the EC Directive 97/23/EC concerning apparatus subjected to pressure, this product must only be used as intended and according to the Owner's manual. Especially observe the following:
 - Products of SKF Lubrication Systems France SAS must not be used in conjunction with fluids, group I (hazardous fluids), according to the definition of article 2 paragraph 2 of the Directive 67/548/EC dtd. 27th June, 1967; and are not approved for application with such fluids.
 - None of the products manufactured by SKF Lubrication Systems France SAS can be used in conjunction with gases, liquefied gases, pressurized gases in solution and fluids with a vapor pressure exceeding normal atmospheric pressure (1013 mbar) by more than 0,5 bar at their maximum permissible temperature.
 - When used as intended, the products supplied by SKF Lubrication Systems France SAS do not reach the limit values listed in the Article 3 par. 1, sections 1.1 to 1.3 and par. 2 of the Directive 97/23/EC. Therefore, they do not come under the requirements set forth in annex I of that Directive. They are not labeled with the CE mark with reference to the Directive 97/23/EC. They are classified by SKF Lubrication Systems France SAS to come under Article 3 par. 3 of the Directive.
 - The EC Declaration of Conformity and EC-Declaration of Incorporation is part of the product documentation.

General

Meaning of symbols and corresponding information

In this manual, the symbols and safety wordings shown on this page are intended to communicate a particular risk to persons, material assets, or the environment.

All safety instructions must be respected by person exposed to these risks. The safety instructions must be communicated to all other persons.

Instructions attached directly to the equipment, such as



- rotational direction arrows
- fluid connection labels, etc.

must be respected and remain perfectly legible.

It is essential to read these instructions thoroughly and to respect the safety instructions given.

Table 1

Hazard symbols

Symbol	Standard	Meaning
	DIN 4844-2 W000	General hazard
	DIN 4844-2 W008	Voltage
	DIN 4844-2 W026	Hot surface
	DIN 4844-2 W028	Slippery floor
	DIN 4844-2 W027	Risk of hand injury
	DIN 4844-2 W55	Risk of pollution

1 Safety instructions

! These instructions must be read and understood by all persons who are involved with the installation, operation, maintenance, and repair of the product. The mounting and operating instructions must be kept close to the equipment for future reference.

Note that these installation instructions is an integral part of the product. It must be handed over to the new operator of the product if the product is sold.

The described product was manufactured in accordance with all generally acknowledged regulations pertaining to technology, occupational safety, and accident prevention. However, dangers that can cause physical injury to persons or damage to other material assets might still occur during the use of the product.

! In addition to the information provided in the installation instructions, all generally applicable regulations on accident prevention and the environment must be observed.

1.1 Intended use

! All products from SKF may be used only for their intended purpose as described in these instructions and in any brochures.

The described product is projecting oil without air for the lubrication of chains and is intended for use in centralized lubrication systems. Other use or use beyond this purpose is considered unintended.

Products of SKF Lubrication Systems France SAS must not be used in conjunction with fluids, group I (hazardous fluids), according to the definition of article 2 paragraph 2 of the Directive 67/548/EC dtd. 27th June, 1967; and are not approved for application with such fluids.

None of the products manufactured by SKF Lubrication Systems France SAS can be used in conjunction with gases, liquefied gases, pressurized gases in solution and fluids with a vapor pressure exceeding normal atmospheric pressure (1013 mbar) by more than 0.5 bar at their maximum permissible temperature.

Unless otherwise noted, products of SKF Lubrication Systems France SAS must not be used in conjunction with explosive atmospheres according to the ATEX-Directive 94/9/EC.

1.2 Authorized personnel

The products described in the installation instructions may only be installed, operated, maintained, and repaired by qualified experts. Qualified experts are persons who have been trained, instructed, and familiarized with the end product into which the described product is installed.

These persons are considered capable of such tasks due to their education, training, and experience with valid standards, conditions, accident prevention regulations in effect, and installation conditions. They should be able to carry out the required tasks and to recognize – and thus avoid – any dangers that might otherwise occur.

A definition of what constitutes a qualified person and who are unqualified persons are stipulated in DIN VDE 0105 and IEC 364.

1.3 Danger relating to electric current

The electrical connection for the described product may only be established by qualified, instructed persons who have been authorized by the operator or owner to carry out this task. If the product is improperly connected, substantial material or personal damage may be the consequence.



DANGER!

Working on products that have not been disconnected from the power supply can cause serious injury or death to persons. Installation, maintenance, and repair work may only be carried out by qualified experts on products that have been disconnected from the power supply. The supply voltage must be turned off before any product components are opened. .

1.4 Danger relating to system pressure



DANGER!

Centralized lubrication systems are under pressure when they are being operated. Such systems must therefore be depressurized before starting installation, maintenance, or repair work and before making any changes to the system.

1.5 Warranty and liability

SKF Lubrication Systems France SAS assumes no warranty and liability if one of the following circumstance should occur:

- Not intended use
- Improper installation/disassembly or improper operation of the product
- Use of contaminated lubricants or lubricants which are not approved
- Improper maintenance or repairing of the product
- Using of unoriginal SKF spare parts
- Making alterations or modifications to the product, which are not approved and signed by SKF Lubrication Systems France SAS
- Non-observance of the advice about transport and storage

2. Lubricants

2.1 General



All SKF Lubrication Systems France SAS products must only be used for their intended purpose and in accordance with the specifications of the installation instructions for the product in question.



You must observe the machinery manufacturer's information on the lubricants to be used in the machinery.

The intended use of this product is for the centralized lubrication/lubrication of bearings and wear points with lubricants. All physical limitations of use stipulated in the documentation of the product such as the owner's manual, technical drawings and catalogs must be observed.

Hazardous materials of any kind, especially the materials classified as hazardous by European Community Directive EC 67/548/EEC, Article 2, Par. 2, may only be used to fill SKF centralized lubrication systems and components and delivered and/or distributed with the same after consulting with and receiving written approval from SKF Lubrication Systems France SAS.

All products manufactured by Lubrication Systems France SAS are not approved for use in conjunction with gases, liquefied gases, pressurized gases in solution and fluids with a vapor pressure exceeding normal atmospheric pressure (1013 mbar) by more than 0,5 bar at their maximum permissible temperature.

Should there be a need to use the product to convey media other than lubricants or hazardous substances, this must be discussed with SKF Lubrication Systems France SAS first and the company must give express written permission.

In the opinion of SKF Lubrication Systems France SAS, lubricants constitute a design element that must be considered when selecting components and designing centralized lubrication systems. The lubrication properties of the lubricants in question must be considered.

2.2 Selection of lubricants



DANGER!

The manufacturer of the bearing or machinery to be lubricated will specify the lubricant requirements for each point to be lubricated. You must make sure that the required quantity of lubricant is provided to the relevant lubricating point. If a lubricating point is insufficiently lubricated, the bearing may become damaged or jammed.

While the machinery/bearing manufacturer usually specifies lubricants, it is the owner/operator (or maintenance person) who must finally select the appropriate lubricant, with the help of the lubricant supplier. When selecting a lubricant, the type of bearing/wear point, the stresses and strains to be expected during operation, and anticipated ambient conditions must be taken into account. All financial/economic aspects must also be considered.



If required, SKF Lubrication Systems France SAS can help customers to select suitable components for the conveyance of the selected lubricant and to plan and design their centralized lubrication system.

If you have further questions, you can contact SKF Lubrication Systems France SAS.

We can test lubricants in our own laboratory to establish their suitability for conveyance (e.g. 'oil separation' behavior) in centralized lubrication systems.

You can request an overview of lubricant tests offered by SKF Lubrication Systems France SAS from our Service Center.

2.3 Approved lubricants



DANGER!

Only lubricants that have been approved by SKF for use with the product may be used. Unsuitable lubricants can cause product malfunctions and damage to property.



DANGER!

Different lubricants must not be mixed together. Doing so can cause damage and require extensive cleaning of the products/centralized lubrication system. To prevent confusion, we recommend that you attach information indicating the lubricant to be used on the lubricant reservoir.

The described product can be operated with lubricants that comply with the specifications in the technical data.

Note that some lubricants may have properties that lie within the permitted limit values and yet not be suitable for use in centralized lubrication systems for other reasons. For example, some synthetic lubricants are not compatible with elastomers.

2.4 Lubricants and the environment

Lubricants are hazardous substance. It is essential to respect any safety instructions given in the lubricant safety data sheet. You can ask the manufacturer of the lubricant for the material safety data sheet.



DANGER!

Lubricants can contaminate the ground and watercourses. Lubricants must be used and disposed of properly. Instructions and local regulations must be observed when handling lubricants.

Note that lubricants are harmful to the environment and flammable; their transportation, storage, and processing are subject to special precautionary measures. For specifications on transportation, storage, processing, and dangers to the use and the environment for the lubricant, refer to the material safety data sheet provided by or available from the lubricant manufacturer. You can ask the manufacturer of the lubricant for the material safety data sheet.

2.5 Danger relating to lubricants



DANGER!

Centralized lubrication systems must be absolutely leak-free. Leaking centralized lubrication systems can cause a slip hazard. When performing installation, maintenance, and repairs test the centralized lubrication system for leaks. Leaky parts of the centralized lubrication system or components of the lubrication equipment have to be sealed immediately.

Leaking centralized lubrication systems or components of the lubrication equipment are a source of danger in relation to slip hazard and the risk of injury. These dangers can cause physical injury to persons or damage to other material assets.

Refer to safety precautions in the lubricant manufacturer's material safety data sheet.

3 Construction and operation

3.1 General

CLK lubrication systems have a central unit and all electrical and hydraulic components necessary to operate a lubrication system by airless oil projection. The central unit comprises a housing with an electromagnetic pump and an integrated control unit and a reservoir. Their compact design makes it very easy to implement the CLK lubrication systems as close as possible to the lubrication points located on a moving chain.

3.2 Versions

The CLK lubrication system can be sold as a kit, mainly containing:

- the CLK central unit
- the projection nozzles
- the inductive proximity sensor
- the lubricant lines
- etc.

The table 2 gives an overview of the several existing kits

3.3 Construction

3.3.1 Central unit

The central unit (→ fig. 1) is a compact group comprising a reservoir mounted on a pump housing.

The pump housing houses an electro-magnetic pump and an integrated control unit. The control unit can be controlled and monitored from the control panel located on the housing front side. For more information on the control unit, refer to the section 6.2 *Control unit*.

The unit electrical connections are located under the rear part of the housing. It comprises three connectors (power supply, proximity sensor and fault outputs). A fourth connector can be optionally added to check the lubricant level.

The hydraulic outlets (lubricant) are located on the housing side.

The reservoir, with a usable capacity of 7.5 l, is made of translucent plastic to facilitate the control of the lubricant level.

Four mounting plates, placed on the reservoir rear side (×2) and on the pump housing rear side (×2) allow the easy mounting of the central unit against a wall or the machine wall.

- long pipe
- short pipe
- nozzles
- inductive proximity sensor

3.3.2 Lubrication system kits

The complete kit of the CLK lubrication system includes, in addition to the central unit, different accessory subsets:

Table 2

Order information, oil lubrication system									
Kit No.	Central unit		Nozzle ¹⁾		Proximity switch ¹⁾			Tube ¹⁾	
	Flow rate	Outlets	Simple	Double	Ø	Temperature	Range	long	short
CLK-460R-100+XXX ²⁾	60	4	–	4	12	-40 to +85 °C	7 mm	1	1
CLK-260R-100+XXX ²⁾	60	2	–	2	12	-40 to +85 °C	7 mm	1	–
CLK-460R-110+XXX ²⁾	60	4	–	4	18	-20 to +180 °C	8 mm	1	1
CLK-430R-101+XXX ²⁾	30	4	4	–	12	-40 to +85 °C	7 mm	1	1
CLK-430R-121+XXX ²⁾	30	4	4	–	8	-40 to +85 °C	4 mm	1	1

^{*)} For more information on subsets, see the technical data
²⁾ The order number has to be completed with the voltage key of the central unit: **428** for 230 V AC, 50/60 Hz and **429** for 115 V AC, 50/60 Hz

CLK central unit

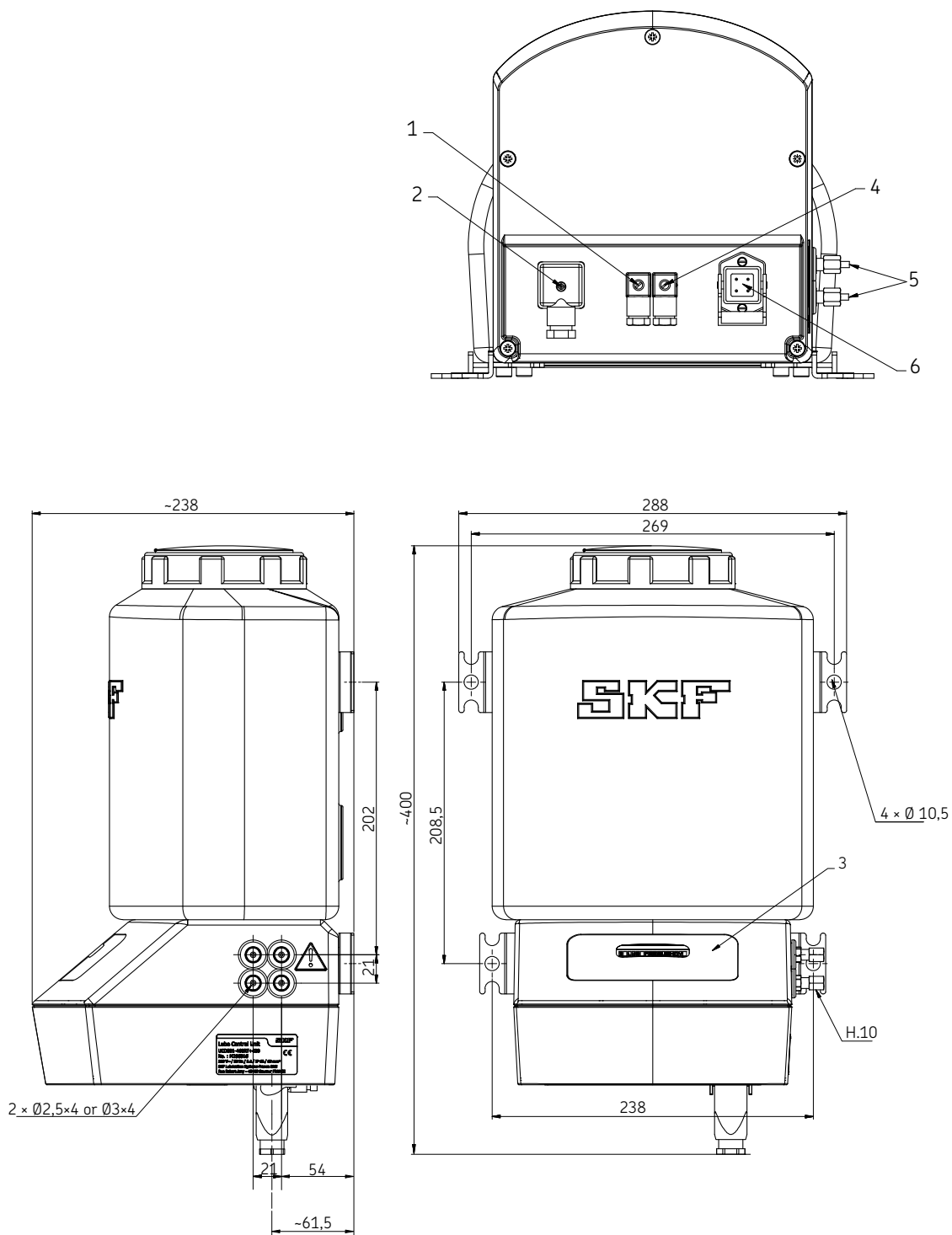

- 1 Level-contact connector (according to the version)
- 2 Fault output connector
- 3 Control panel of the control unit
- 4 Proximity sensor connector
- 5 Lubricant outlets
- 6 Power supply connector

Fig. 2

Projection nozzles with proximity sensor mounted on a support

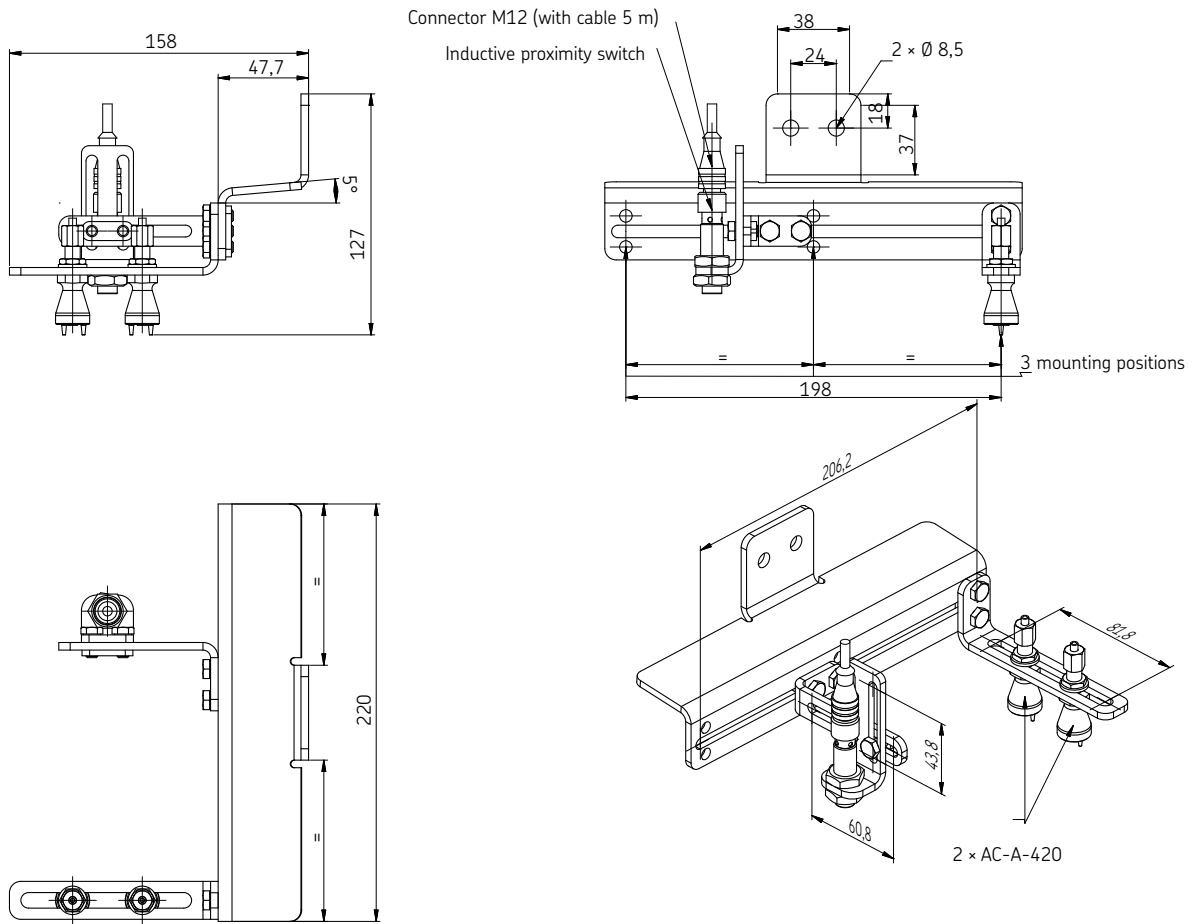
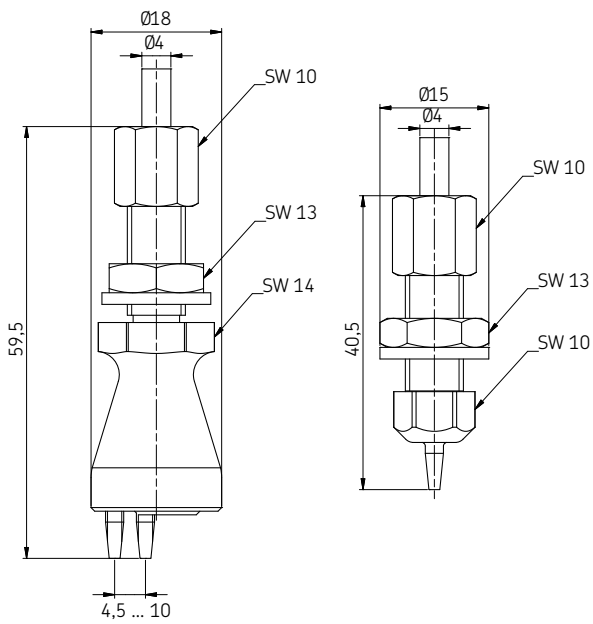

Fig. 3

Projection nozzles



3.3 Function

The CLK-type lubrication systems for conveyor chains generally comprise a piston pump with electromagnetic control, an oil reservoir and a control unit. The lubricant is supplied to the lubrication points by means of projection nozzles.

3.3.1 Oil projection

With these systems the lubricant is projected to the lubrication point without any mechanical contact.

Lubrication is done while the chain is moving.

For optimal oil projection, very small amounts of oil should be projected at a specific time on the chain lubrication point. A proximity sensor is used to accurately determine the position of the chain, the rollers and the links, and so the exact time for projecting the lubricant. When the passage of the lubrication point is detected, the control unit triggers a lubrication pulse. At each lubrication pulse, the electromagnetic pump releases precise lubricant doses - 60 mm^3 /pulse - which are projected toward the lubrication point.

The user sets, from the integrated control unit, the duration of the lubrication cycle. For more information, see section 6.2 *Control unit*.

3.3.2 Capillarity

When the lubricant has reached the lubrication point by projection, it penetrates between the different elements of the chain by capillarity. A lubricant film is formed at the friction zones. It reduces the temperature rising and therefore the part wear. In addition, it provides extra protection against external pollution, by preventing the foreign matter (dust, particles ...) to penetrate between the different parts.

Friction zones

The chains have a large number of friction zones that should be lubricated. The example below shows a sectional view of a roller chain with different parts and friction zones.

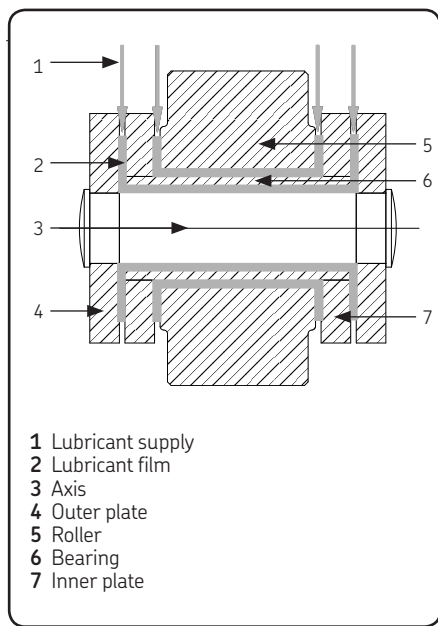

4. Installation instructions

The lubrication system described in the mounting instructions may only be installed, operated, maintained, and repaired by qualified experts. Qualified personnel are persons who have been trained, instructed, and familiarized by the user of the end product into which the system is installed. These persons are considered capable of such tasks due to their education, training, and experience with valid standards, conditions, and installation conditions. They should be able to carry out the required tasks and to recognize – and thus avoid – any dangers that might otherwise occur.

A definition of what constitutes a qualified person and who are unqualified persons are stipulated in DIN VDE 0105 and IEC 364.

Before installing/positioning the lubrication system, remove the packaging material and any transportation safety devices such as sealing plugs. Keep the packaging material until any and all problems have been clarified.



CAUTION!

The lubrication system must not be overturned or discarded.

Country-specific accident prevention regulations and the operating and maintenance instructions for the operator must be observed when carrying out all installation work on machines.



CAUTION!

The conveyor chain should be stopped during work of installation, adjustment, maintenance or repair of the lubrication system to prevent any risk of accidents.

4.1 Positioning

The system must be mounted in a way that protects it from humidity and vibrations. It should also be easily accessible so that all other installation work can be carried out without hindrance. Ensure that there is sufficient circulating air to prevent the system from overheating. For information on the maximum admissible ambient temperature, see the technical data section.

The product should be mounted vertically in accordance with documentation data.

The control panel of the control unit should be easily accessible to allow the user to control the operation of the system and to make various adjustments. The lubricant reservoir should be clearly visible to easily check the lubricant level.

The location of the lubricating system always depends on the machine configuration. However, SKF recommends to follow this instructions:

- The projection nozzles should be placed at the starting point and above the return belt of the conveyor chain
- The line maximum length between the central unit and the projection nozzles should not exceed 5 m.
- The connection maximum length between the central unit and the proximity sensor should not exceed 5 m.

Fig. 4

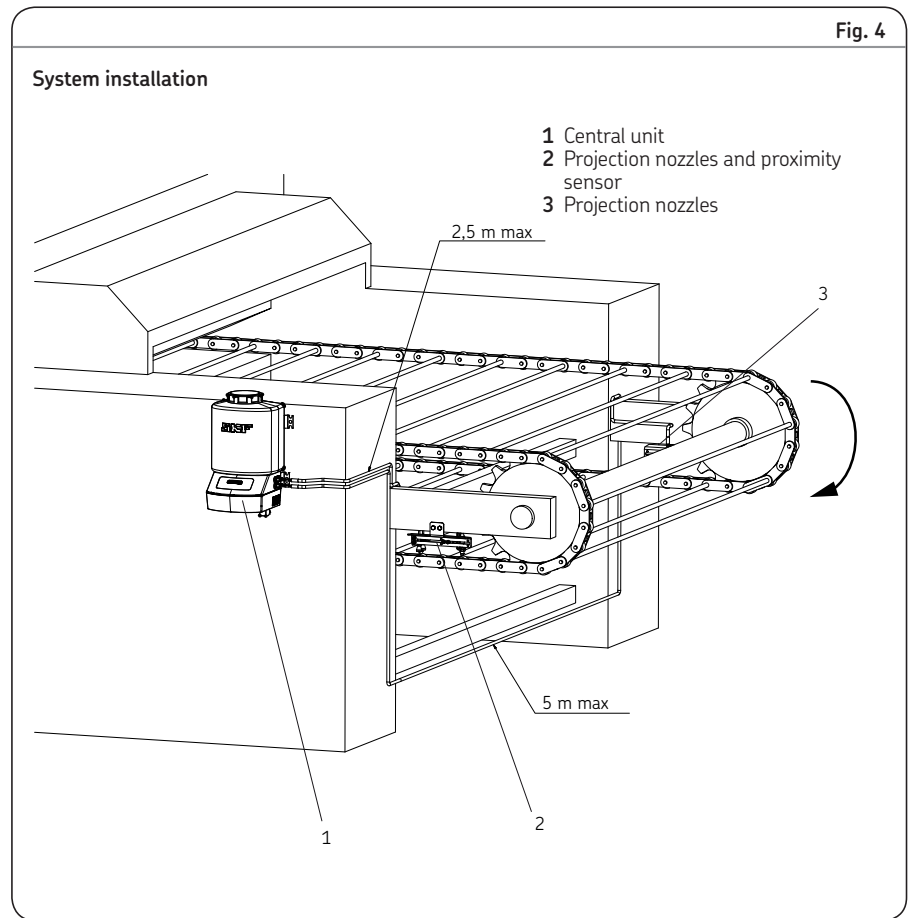

CAUTION!

The projection nozzles and the proximity sensor operate in different temperature ranges. It is not therefore necessary to check the ambient temperature and the working temperature of the place where the nozzles and the sensor will be placed.

4.2 Installation

During installation, and more specifically when holes should be carried out, it is mandatory to observe the following points:

- During installation, do not damage the existing lines.
- During installation, do not damage the other existing groups.
- The central unit should not be mounted in the range of moving parts.
- The central unit should be installed at a sufficient distance from heat sources (→ **Technical data**).
- It is mandatory to observe the safety distances, as well as local guidelines on installation and accident prevention.
- Use existing holes if possible.
- Use washers if the holes on the holder are too large.

4.2.1 Installing the central unit

The central unit is intended to be mounted on a wall.

The central unit has four mounting plates, two located in the reservoir, and two on the housing (→ **fig. 5**). The mounting plates are intended for M8 × 1.25 Class 8.8 (metal bracket) screws or expansion metal plugs and diameter 8 screws. Mounting is carried out in the space provided for this purpose and with the appropriate mounting material (e.g., screws, washers, nuts).

It is important to provide a free space (→ **fig. 6**) around the central unit to allow all installation and maintenance works, as well as the unit filling.

CAUTION!

It is necessary to properly secure the lubrication system on its support to prevent any accidental system fall. A system fall may damage it or cause material damage and can also injure the operator or other people.

Fig. 5

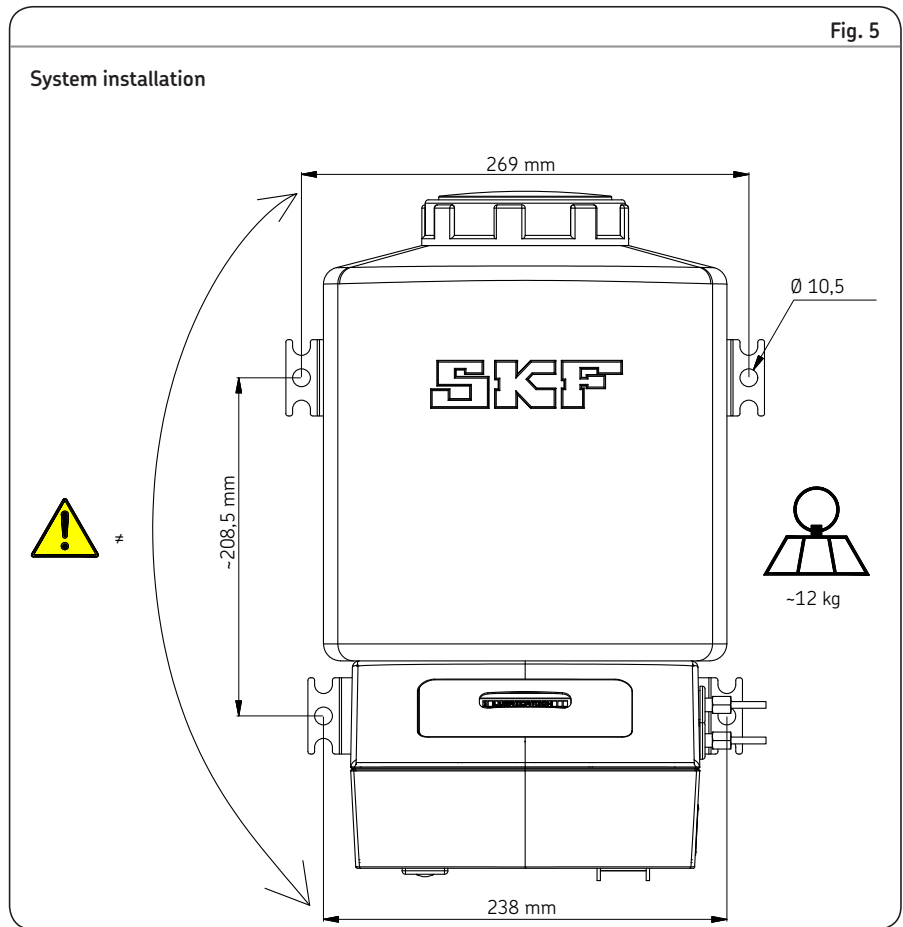
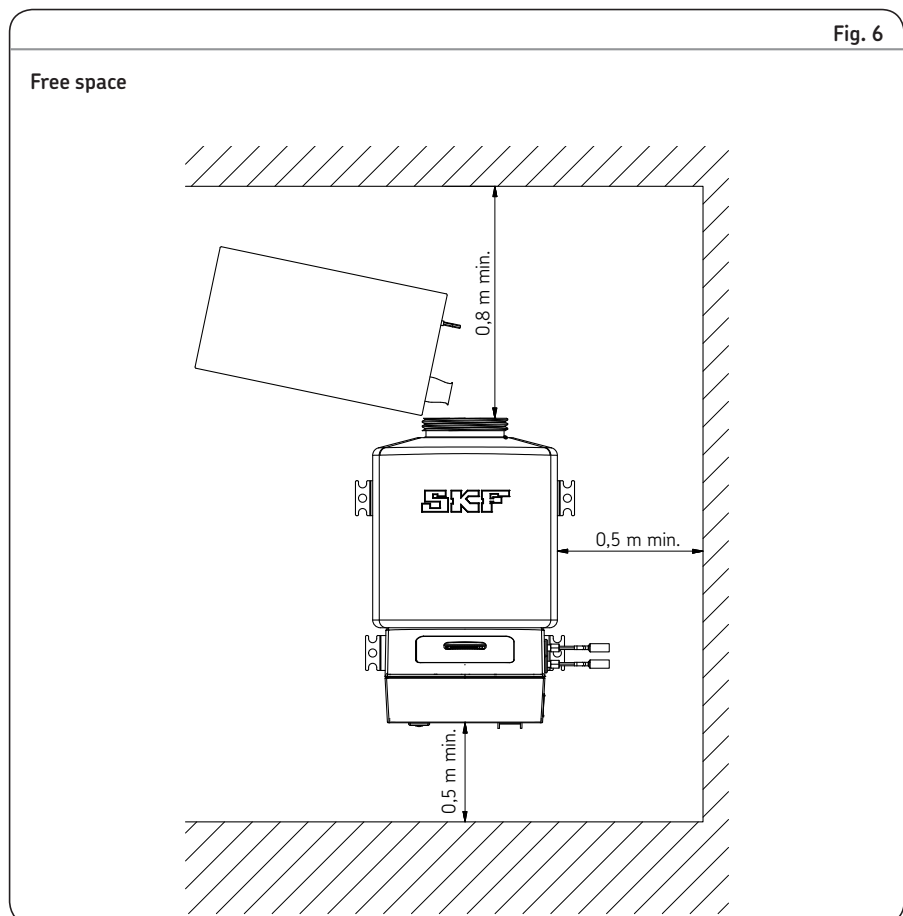

Fig. 6



4.2.2 Nozzle installation



CAUTION!

Only remove the protections from the projection nozzle heads at the last moment to avoid any damage due to installation work.

The nozzles should be placed directly above the chain rollers, at the starting point of the chain return belt (→ fig. 4). The projection head should be placed vertically with respect to the lubrication point - i.e. the friction zone between two roller elements, (→ fig. 7). In the case where the two projection heads of the nozzle are not perfectly aligned, it is possible to adjust the gap between them.



CAUTION!

The projection nozzles should be perfectly vertical to the chain rollers. It is also mandatory to observe the installation distances of the nozzles.

4.2.2.1 Nozzle adjustment

The center distance between the two spray heads of a nozzle is min 4.5 mm and max 10 mm. The nozzle heads should be perfectly vertical to the lubrication points (→ fig. 8). Depending on the chain roller configuration, you can adjust mechanically the center distance between the nozzle heads by means of a 2,5 mm Allen wrench (→ fig. 7).

4.2.2.2 Nozzle mounting

To mount the projection nozzles, you can use the support provided for this purpose (→ fig. 9). Once the support is mounted, it is only possible to adjust horizontally the projection nozzle position. SKF recommends therefore to simulate the nozzle positioning

with respect to the chain before mounting the support.

- Install and mount the support. Depending on the chain configuration, the support can be mounted in two different ways (→ fig. 10).
- Place and secure the nozzles bracket (three possible positions) (→ fig. 9). Observe the distances
- Insert the nozzles in the bracket slot from below
- Insert and slightly tighten the washer and the nut

- Adjust the nozzle position by sliding them along the slot
- Tighten the nut



CAUTION!

The chain to be lubricated is moving during the process. It is therefore important to follow the installation distances to avoid any mechanical damage to the projection nozzles.

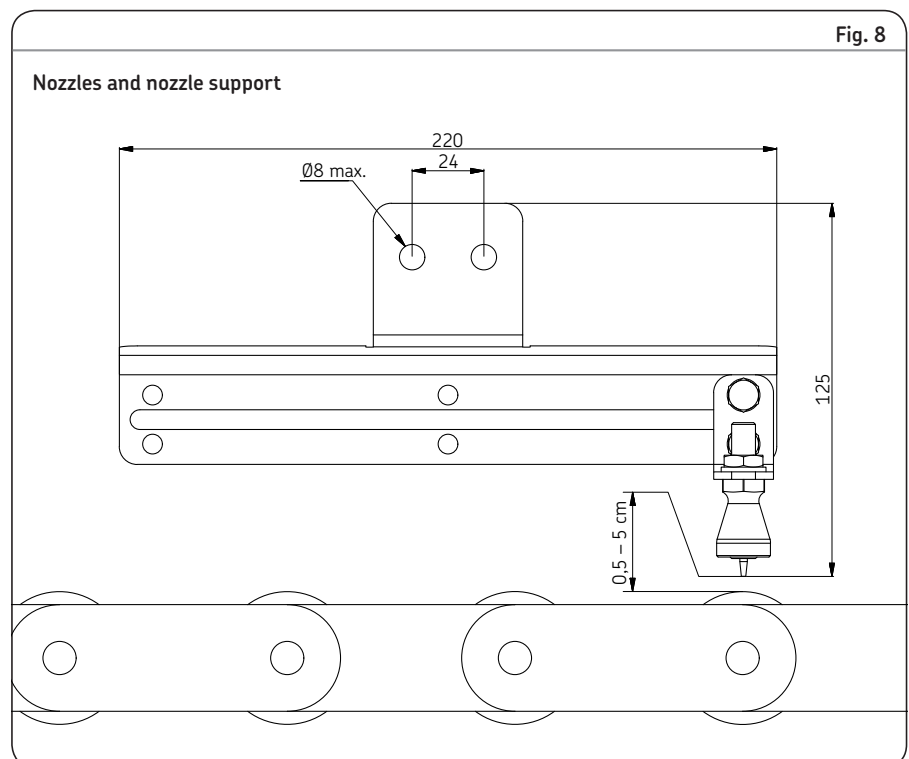
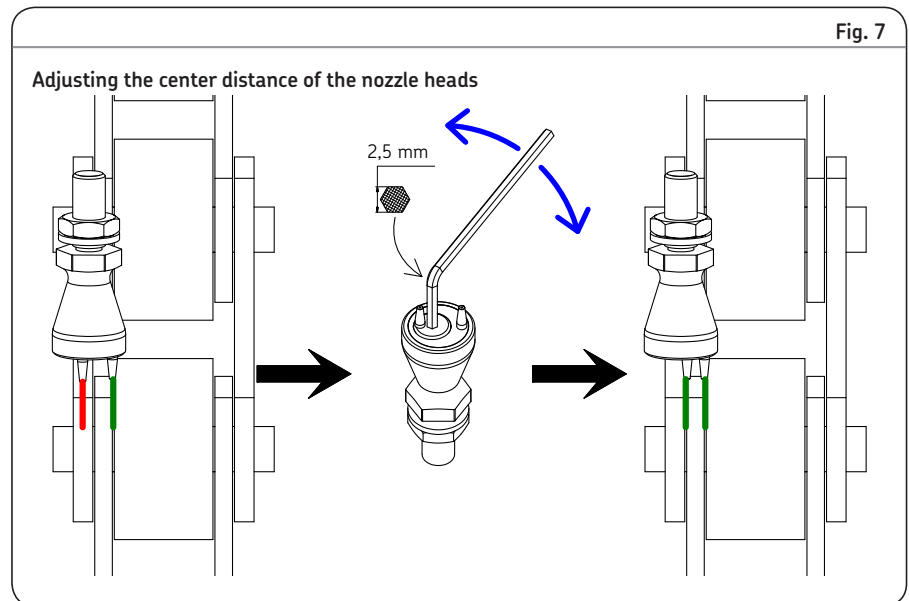

4.2.3 Mounting the proximity sensor

The proximity sensor is mounted on the same support as the nozzles. SKF recommends to place the proximity sensor before the projection nozzle relative to the chain travel direction.

CAUTION!

It is necessary to observe the installation distances of the proximity sensor.

- Mount the sensor on the bracket with the nut and the lock nut
- Mount the bracket on the support
- Adjust the sensor horizontal and vertical position (→ **fig. 11**). It must be vertical with respect to a lubrication point
- Observe the rated range of the sensor (→ **Technical data**)

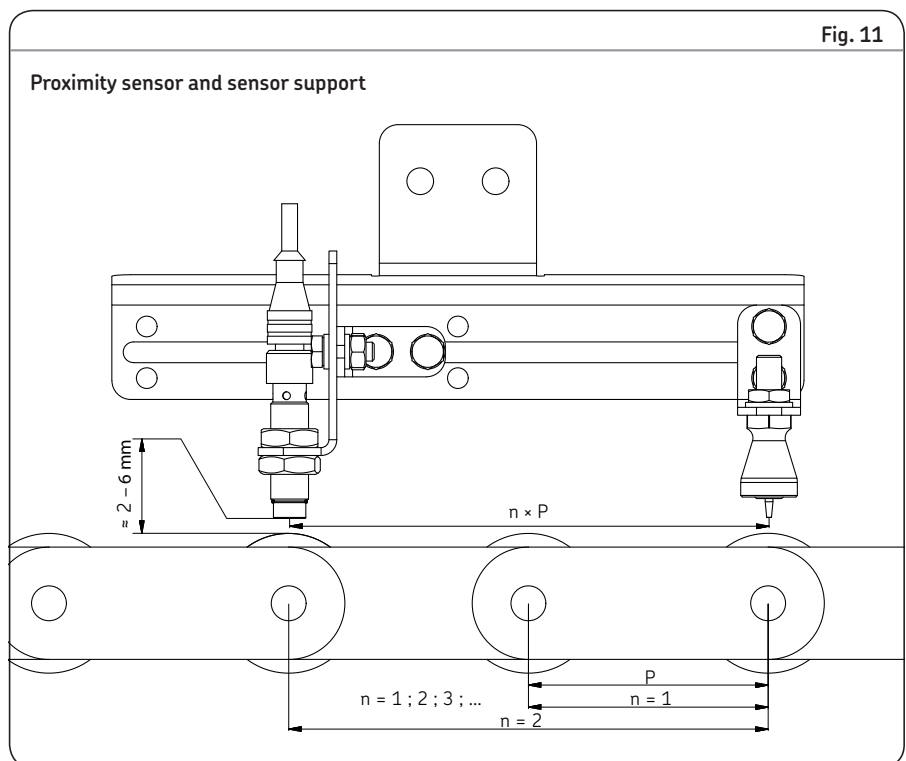
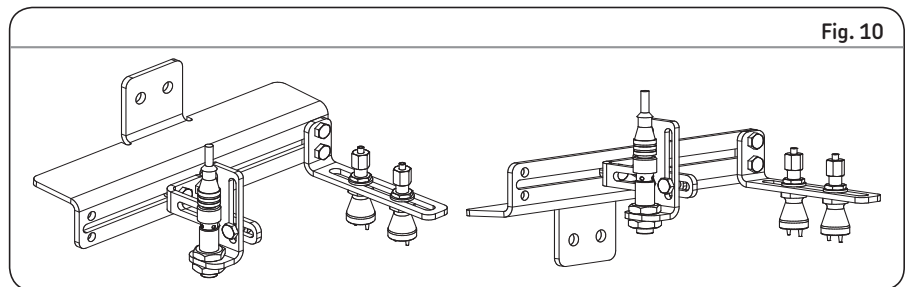
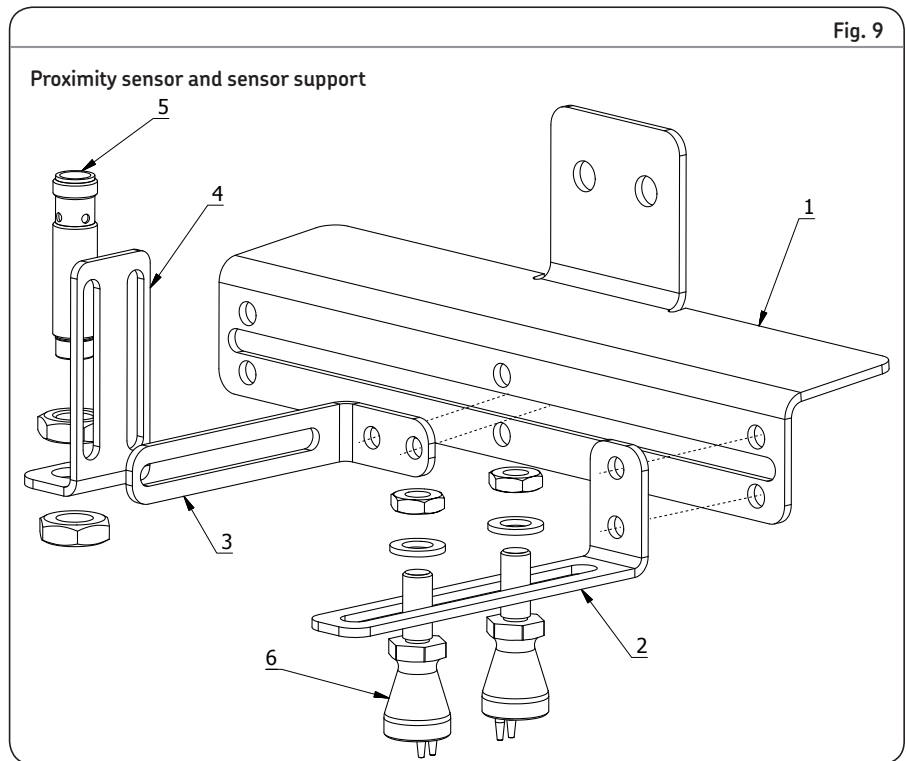

4.3 Hydraulic connections

The lubrication line should be connected to the central unit so that no force can be transmitted to the unit once installed (no pressure on the connection).



CAUTION!

The connectors and accessories used to connect the lubricant line must be compatible with the pump's maximum service pressure.



The line maximum length between the central unit and the projection nozzles is 5 m. For a higher length, contact the SKF Service Center.

4.3.1 Central unit outputs

The central unit is equipped with two to four lubricant outputs depending on the model. These outputs are located on the housing side. The connection is made by crimp ring fittings for stainless steel pipes with an outer diameter of 4 mm (→ fig. 12).

4.3.2 Nozzles

The nozzle connection (→ fig. 13) is made by crimp ring fittings for stainless steel pipes with an outer diameter of 4 mm

Fig. 12

Central unit output connection

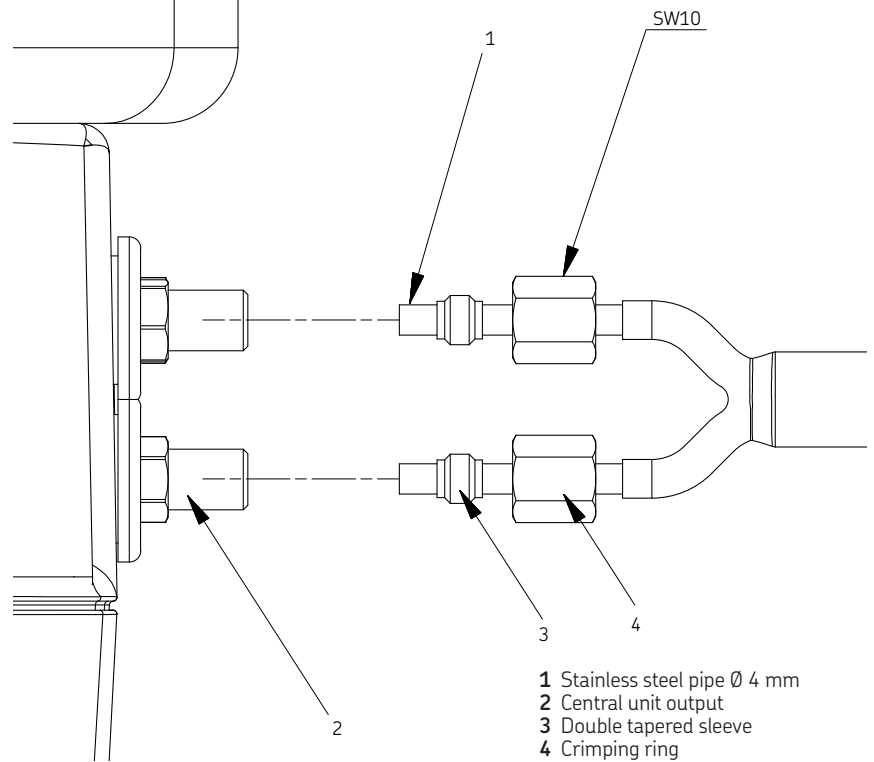
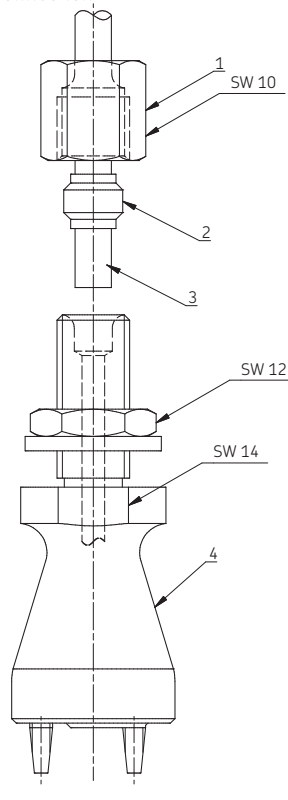

Fig. 13

Nozzle connection



4.4 Electrical connections



DANGER!

Only qualified, instructed specialists who are authorized by the operator may install the electrical connections for the lubrication unit. The connection conditions and the local regulations (e.g. DIN, VDE, NF) must be scrupulously respected. Any unsuitable connections on the MQL system may result in serious material damage and bodily injury.

The user should carry out three electrical connections to the central unit, namely:

- the power supply connector (→ pos. 4 fig. 14)
- the connector for the proximity sensor (→ pos. 3 fig. 14)
- the connector for the default output (→ pos. 1 fig. 14)
- the fourth connector (→ pos. 2 fig. 14) is optional for external connection of the level-contact

4.4.1 Power supply

The power supply of the CLK central unit is 230 V~, 50/60 Hz (voltage key + 428) or 115 V~, 50/60 Hz (voltage key + 429).

For the pin assignment on the power supply connector, see Table 2.



DANGER!

The supply voltage on site must agree with the information on the codification of the lubrication system. Check the fusing of the circuit. Use only the original fuse with the required ampere value. If other fuses are used, damage to property or personal injury may be the consequence.

Fig. 14

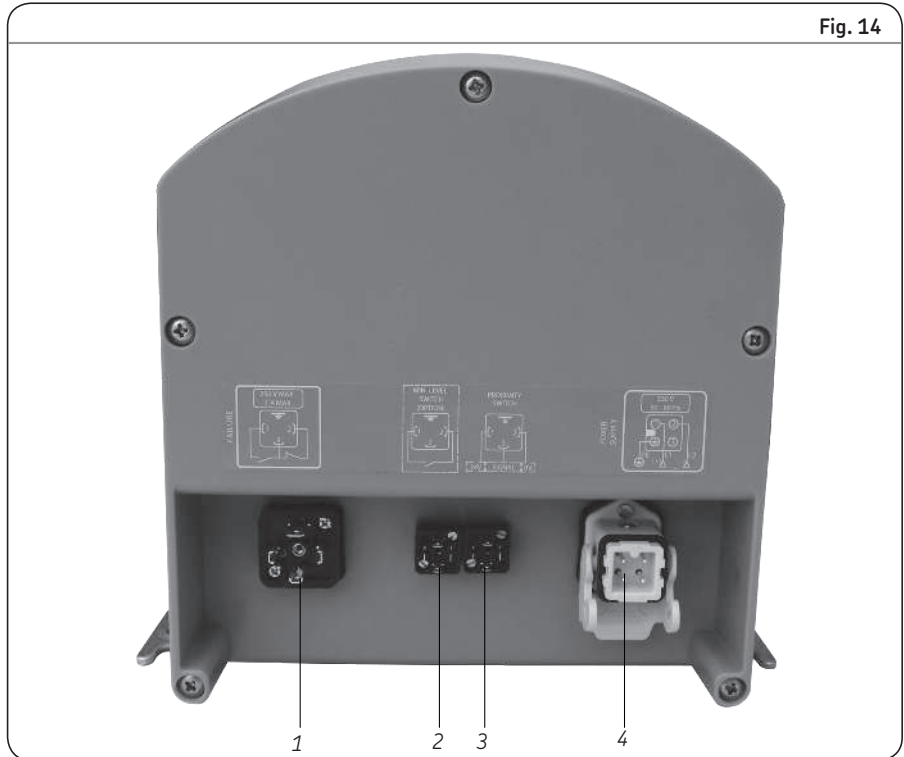

CLK electrical connection

4.4.2 Fault output

The user can connect the fault output to an external light signal or to its control panel. The user can therefore get more easily the fault information.

For the pin assignment on the fault output connector, see Table 3.

4.4.3 Proximity sensor

An inductive proximity sensor is placed at the chain. It detects the passage of the lubrication points. When the system is in lubrication phase, the sensor sends a signal to the control unit each time it detects a lubrication point. The control unit triggers an lubrication pulse.

For the pin assignment on the proximity sensor connector, see Table 4.

Table 2

Power supply connector pins

Pin	Description
1	L – phase
2	N – neutral
GND	GND – grounding

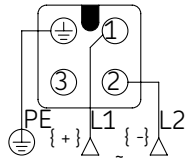

Table 3

Default output connector pins

Pin	Description
1	NO – closing contact
2	NC – opening contact
3	common

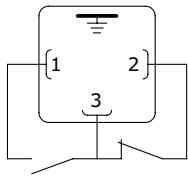
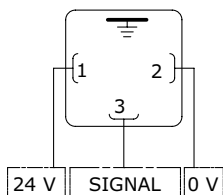

Table 4

Proximity sensor connector pins

Pin	Description	Wire color
1	24 V	brown
2	0 V	blue
3	Signal	black



5 Transport, delivery and storage

5.1 Transport

SKF Lubrication Systems France SAS products are packaged in accordance with the regulations of the recipient country and in accordance with DIN ISO 9001. Our products must be transported with care. Products must be protected against mechanical influences such as impacts. Transport packaging must be labeled with the information 'Do not drop!'.

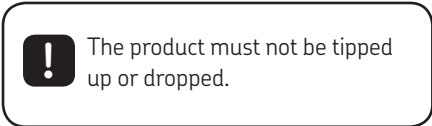

There are no restrictions relating to land, air, or sea transportation.

5.2 Delivery

Following receipt of the shipment, the product or products must be checked for damage and the shipping documents should be used to make sure that the delivery is complete. Keep the packaging material until any and all problems have been clarified.

5.3 Storage

The following conditions apply to the storage of SKF Lubrication Systems France SAS products.

5.3.1 Storage of lubrication units

- Ambient conditions: dry, dust-free environment; storage in well-ventilated, dry area
- Storage time: 24 months max.
- Permitted air humidity: < 65%
- Warehouse temperature: 10 – 40 °C
- Light: direct sunlight/UV radiation must be avoided; nearby sources of heat must be screened

5.3.2 Storage of electronic and electrical devices

- Ambient conditions: dry, dust-free environment; storage in well-ventilated, dry area

- Storage time: 24 months max.
- Permitted air humidity: < 65%
- Warehouse temperature: 10 – 40 °C
- Light: direct sunlight/UV radiation must be avoided; nearby sources of heat must be screened

5.3.3 Storage – general information

- Ensure that no dust gets into stored products by wrapping them in plastic film
- Store products on racks or pallets to protect them from damp floors
- Before placing products into storage, protect uncoated metal surfaces - and drive parts and mount surfaces in particular - from corrosion using long-term corrosion protection.

6. Activation

6.1 General

The product described operates automatically. However it is recommended that you regularly verify that the lubricant is correctly transported along the lines.

The level of lubricant in the reservoir, if present, must be checked visually at regular intervals. When the lubricant level is low, fill up with lubricant, as described in chapter *Filling with lubricant*.



You must observe the machinery manufacturer's information on the lubricants to be used in the machinery.



CAUTION!

Only use a clean lubricant. Soiled lubricants can cause major defects in the system.



CAUTION!

Different lubricants must not be mixed together. Doing so can cause damage and require extensive cleaning of the lubrication system. To prevent any risk of error, it is recommended to clearly identify the lubricant used on the reservoir.

6.2 Control Unit

The UCDE central unit features an integrated command and control unit. The main function of this unit is to trigger a lubrication pulse upon reception of a signal from the proximity sensor placed on the chain to be lubricated.

6.2.1 Interface

The command and control unit features an easy-to-use interface in front of the UCDE unit housing (→ **fig. 15**).

This interface includes:

- a 2 × 16 digit screen
- four buttons (→ **Table 5**)
- a LED (default)

6.2.2 Control unit menus

The control unit software has seven main menus. These menus are numbered for easy identification.

- 1 Display: real-time display of the lubrication status
- 2 Lubrication: configuration of lubrication mode (cyclic, semi-automatic or continuous) and cycle time in case of cyclic lubrication (modifiable by the user).
- 3 Number of axes: configuration of number of axes to be lubricated on the chain for each lubrication cycle (changeable by the user)
- 4 Fine adjustment: adjustment of the projection position relative to the chain
- 5 Draining: lubrication circuit draining
- 6 Languages: selection of the control unit interface language
- 7 Status of inputs and outputs

To move from one menu to another, press the navigation buttons.

Table 5

Buttons on the control unit





Button	Description
	Manual start of the lubrication / stop of the lubrication in progress
	Navigation or increment
	Navigation or decrement
	Validation / access to a parameter for modification (press ca. 5 s)

Fig. 15



User interface

6.2.3 Parameters

The control unit allows you to adjust various parameters.









6.2.3.1 Lubrication

The lubrication parameter allows to adjust the lubrication system mode: cyclic, semi-automatic or continuous. In case of cyclic lubrication, you should set a time correspond-

ing to the time between two lubrication cycle start-ups. The cycle includes the lubrication phase, determined by the number of axes of the chain (→ § 6.2.3.2), followed by the pause phase. The minimum cycle time is 0 h 01 min, and the maximum cycle time is 999 h 59. The default set value is 0 h 01 min.

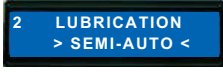
Table 6

Lubrication, menu 2

Screen	Description
	<ul style="list-style-type: none"> Go to menu 2 <i>Lubrication</i> with  Enter the menu by pressing for 5 seconds 
  	<ul style="list-style-type: none"> Select the lubrication mode with  <ul style="list-style-type: none"> Continuous* Semi-automatic* Cyclic <p>If you select cyclic lubrication, it is necessary to set the cycle time with the same keys. The minimum cycle time is 0 h 01 min, and the maximum cycle time is 999 h 59.</p> <p>*) To access the Continuous and Semi-automatic parameters, you have to lower the time to 0 h 01 min</p> <ul style="list-style-type: none"> Confirm and go back to menu 2 <i>Lubrication</i> by pressing 

Lubrication cycle

A lubrication cycle consists of a lubrication phase, during which the lubrication points are lubricated, followed by a pause phase. There are two parameters to be set: the duration of the lubrication cycle in time and the number of chain roller to be lubricated during the lubrication phase. The length of the pause phase depends on the total number of lubrication points and the duration of the lubrication cycle.

Semi automatic lubrication

The user manually triggers the lubrication phase. This phase corresponds to the number of lubrication points set by the user. Once the last point has been lubricated, the lubrication phase is done and the system stops. The user can trigger another lubrication phase whenever necessary.

Continuous lubrication





All lubrication points are continuously lubricated as long as the chain is running and the lubrication system is powered.

6.2.3.2 Chains

The *Chain* parameter allows to set the number of lubrication points to be lubricated during a lubrication cycle. The minimum

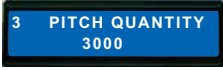
number of points is 0, and the maximum number of points is 9,999. The default value is 100.

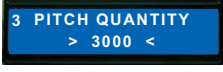
Table 7

Number of axes, menu 3	
Screen	Description
	<ul style="list-style-type: none"> Go to menu 3 <i>Number of axes</i> with  Enter the menu by pressing for 5 seconds 
	<ul style="list-style-type: none"> Set the number of axes with  <p>The minimum number of points is 0, and the maximum number of points is 9,999.</p> <ul style="list-style-type: none"> Confirm and go back to menu 3 <i>Number of axes</i> by pressing 

6.2.3.3 Fine adjustment – Nozzle position

The user can adjust the position of the nozzles relative to the lubrication points, without mechanical intervention. To do so, the

user increases or decreases the lubrication signal advance in order to refine the accuracy of the projection impact.







 The fine adjustment has to be carried out during a lubrication phase.









Table 8

Fine adjustment, menu 4	
Screen	Description
	<ul style="list-style-type: none"> Go to menu 4 <i>Fine adjustment</i> with  Enter the menu by pressing for 5 seconds 
	<ul style="list-style-type: none"> Increase or decrease advance of the position of the impact on the chain with  Confirm and go back to menu 4 <i>Fine adjustment</i> by pressing 

6.2.3.4 Languages

The user can select the language of the control unit interface. Three languages are available: English, French and German.

Table 9







Languages, menu 6	
Screen	Description
	<ul style="list-style-type: none"> Go to menu 6 <i>Languages</i> with   Enter the menu by pressing for 5 seconds 
	<ul style="list-style-type: none"> Select a language with   <p>The following languages are available: English, French and German</p> <ul style="list-style-type: none"> Confirm and go back to menu 6 <i>Languages</i> by pressing 

6.3 Bleeding

It is essential to bleed (lubrication line filling) the system before commissioning and after works carried out on the lubrication lines. You should start bleeding from the control unit. To facilitate bleeding, it is recommended to initially bleed without nozzles.

- At the beginning of the bleeding phase, the lubrication system is off
- If the nozzles are already connected to the lubrication system, remove the fittings to separate nozzles from the system
- Switch the central unit on
- Start draining following the procedure described in Table 10
- Once the lubricant comes out from all lines with no air bubbles, stop bleeding
- Turn the system off
- Connect the nozzles to the lines
- Turn the lubrication system on again
- Restart bleeding until the lubricant comes out from all nozzles with no air bubbles

Table 10

Draining, menu 5	
Screen	Description
	<ul style="list-style-type: none"> Go to menu 5 <i>Draining</i> with   Start draining by pressing for 5 seconds 
	<ul style="list-style-type: none"> Stop draining by pressing 

 The lubrication lines do not have the same length. The duration of the bleeding phase can vary. SKF estimates the bleeding lasts ca. 5 min for the 5 m long lubrication line, i.e. 1 m/min average

6.4 Filling with lubricant

- Clean the filling cap before removing it
- Remove the reservoir cap and fill up with an appropriate lubricant.
- Put back the reservoir cap.



Only authorized lubricants for the pump type may be supplied. Un-suitable fluids may cause the unit to fail and lead to serious material damage and bodily injury.



Ensure the reservoir is filled with lubricant that does not contain air bubbles.



If the ambient air is polluted, set aside a clean zone to fill the system and thereby prevent foreign bodies from entering. It is also important to clean the reservoir cover or the filler plugs before removing them.

6.5. Commissioning





Before activation, check all electrical and hydraulic connections.

Once the CLK lubrication system is on, the lubrication process starts according to user configuration.

The user can follow the progress of the lubrication process at any time by reading the messages displayed on the central unit (→ Table 11)

Table 11

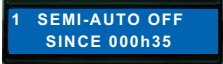
Display, menu 1

Screen	Description
	<ul style="list-style-type: none"> • The lubrication system is operating in cyclic mode. Lubrication phase is in progress. <ul style="list-style-type: none"> – 0357 = number of axes lubricated – 3000 = number of axes to be lubricated – 000h08 = time elapsed since the beginning of the lubrication cycle
	<ul style="list-style-type: none"> • The lubrication system is operating in cyclic mode. Pause phase is in progress. <ul style="list-style-type: none"> – 000h00 = pause time elapsed – 000h30 = pause time remaining
	<ul style="list-style-type: none"> • The lubrication system is operating in semi-automatic mode. Lubrication phase is in progress. <ul style="list-style-type: none"> – 0003 = number of axes lubricated – 3000 = number of axes to be lubricated
	<ul style="list-style-type: none"> • The lubrication system is operating in semi-automatic mode. Lubrication phase is completed. <ul style="list-style-type: none"> – 000h35 = time elapsed since the lubrication of the first axis
	<ul style="list-style-type: none"> • The lubrication system is operating in continuous mode. Lubrication phase is in progress. <ul style="list-style-type: none"> – 0006 = number of axes lubricated – 3000 = number of axes to be lubricated (loop counting)

7. Shutdown

7.1 Temporary shutdown

You can temporarily shut down the described product by disconnecting the electrical, pneumatic, and/or hydraulic supply connections. For more information, see the section 'General information' in this installation instructions.

If you wish to shut down the product temporarily, refer also to the instructions in the section 'Transport, delivery, and storage' of this manual.

When placing the product back into operation, refer to the information in the sections *Installation* and *Commissioning* of this manual.

7.2 Permanent shutdown

All country specific legal guidelines and legislation on the disposal of contaminated equipment must be observed when shutting down the product for the final time.

! Caution!

Lubricants can contaminate the ground and watercourses. Lubricants must be used and disposed of properly. Instructions and local regulations must be observed when handling lubricants.

The system can also be taken back by SKF for disposal if the costs are covered.

8. Maintenance

! CAUTION!

Working on products that have not been disconnected from the power supply can cause serious injury or death to persons. Installation, maintenance, and repair work may only be carried out by qualified experts on a product that is not connected to a power supply. The supply voltage must be turned off before any product components are opened.

! CAUTION!

The lubrication system may be under pressure. Centralized lubrication systems must therefore be depressurized before starting installation, maintenance, or repair work and before making any changes to the system.

! CAUTION!

The described product may be under pressure when it is being operated. The product must therefore be depressurized before starting installation, maintenance, or repair work and before making any changes to the system.

side of the product does have to be cleaned. If this occurs, contact SKF Lubrication Systems France SAS Services for more information on cleaning procedures.



You must not dismantle the product or parts of the product during the warranty period. Doing so invalidates all warranty claims.

Only original SKF Lubrication Systems France SAS spare parts may be used. It is prohibited for the operator to make alterations to the product or to use non original spare parts and resources. Doing so invalidates all warranty claims.

SKF Lubrication Systems France SAS is not liable for damage caused by improper installation, maintenance, or repair work.

SKF Lubrication Systems France SAS products are low-maintenance. However, to ensure that they function properly and to avoid risks right from the startup, all joints and connections should be checked to make sure that they are properly fitted.

If necessary, you can clean the pump using gentle, material-appropriate cleaning agents (no alkalis, no soap). For safety reasons, the pump should be disconnected from the electric supply before cleaning.

During cleaning, it is important to make sure that no cleaning agent enters the inside of the pump.

If the system is operated normally with intercompatible lubricants, the inside of the product does not need to be cleaned.

If you accidentally fill the pump with an incorrect or contaminated lubricant, the in-

9. Failures

Tables 12 and 13 give an overview of possible malfunctions and their causes. If you are unable to rectify the malfunction, please contact SKF Lubrication Systems France SAS Service Center.

 You must not dismantle the product or parts of the product during the warranty period. Doing so invalidates all warranty claims.

All other work relating to installation, maintenance, and repair must only be carried out by SKF Lubrication Systems France SAS Service.







 Only original SKF Lubrication Systems France SAS spare parts may be used. It is prohibited for the operator to make alterations to the product or to use non original spare parts and resources.

Table 12

Failure analysis and remedy

Problem	Possible cause	Solution
	Not enough oil in the reservoir	Fill up the reservoir
	Damaged sensor	Replace the sensor
	Disconnected connector	Reconnect the connector
	Cut or damaged cable	Repair or replace the cable
	Wrong sensor used	Use only SKF-provided sensors
	Lubrication stopped manually	Restart lubrication by pressing 
	Information that the sensor works, but it does not detect any link	
	The sensor is too far from the link	Adjust the sensor position (→ 4.2.3)
	Chain stopped or very slow	The system works but indicates links too seldom detected

Failure analysis and remedy		
Problem	Possible cause	Solution
The system does not work	Power supply	<ul style="list-style-type: none"> • Check connections and cables • Check that the supply voltage corresponds to the one indicated on the rating plate • Check the connector wiring
No lubricant exits the nozzle	Lack of lubricant	<ul style="list-style-type: none"> • Check the lubricant level in the reservoir and top up if necessary. • Check that the lubricant used is compliant with the system technical data. If this is not the case, you should: <ul style="list-style-type: none"> – Drain the lubricant in accordance with the applicable local rules and laws regarding the disposal of lubricant – Thoroughly clean the entire system – Fill up with a suitable lubricant and carry out a new system draining • Check the condition of the strainer down in the reservoir and clean it if necessary. Before restarting the system, you must perform a new draining.
	Wrong lubricant	
	Reservoir strainer clogged	
	Fittings	
	Lines	
	Clogged nozzle head	<ul style="list-style-type: none"> • Check the fittings on both sides, tighten if necessary • Check the condition of lines (fracture, cut, pinch), and replace them if necessary • Check and clean the nozzle heads • Replace the nozzles
	Damaged nozzle head	

10. Technical data

Table 14

Technical data

CLK lubrication system

Pumping unit

Flow rate	60 mm ³ per stroke and per output
Lubricant	mineral or synthetic oils without additives
Viscosity	<100 mm ² /s (cSt) at projection temperature
Discharge pressure	< 100 bar
Working frequency	< 3 strokes/s
Life	20 × 10 ⁶ cycles maximum
Operating temperature	60 °C max.
Altitude	< 2,000 m
Reservoir capacity	7.5 l (usable capacity)
Level monitoring	Minimum level check
Material, reservoir	HDPE
Material, housing	ABS
Weight	approx. 12 kg (reservoir full)
Acoustic emission	≤ 70 dB (A)
Protection class	IP 65

Operating voltage	230 V-
Frequency	50 Hz
Current	5.5 A
Network overvoltage category	2 500 V
Fuse	2.5 A (T2.5AL250V)
Network type	TN
Power supply connector	24 square, female, 3 x 1.5 mm ²
Inductive proximity sensor connector	DIN43650 type C
Minimum level connector (according to version)	DIN43650 type C
Fault output connector	DIN43650 type A

Projection nozzle

Type	Projection nozzle with one or two outlets
Projection	vertical, top-down
Volume	30 mm ³ /stroke and outlet
Projection distance	5 to 50 mm
Lubricant	mineral or synthetic oil with a max. viscosity < 100 mm ² /s (cSt) at projection temperature
Operating temperature	-25 to +220 °C
Off service temperature	-40 to +220 °C
Lubricant inlet	for metallic tube Ø 4 mm, length 5 m max.
Weight	approx. 50 g
Material	stainless steel 304, FPM seal for check valves
Number of nozzles	2
Accessories	holder and fittings

Inductive proximity sensor

Sensor type	3-wire DC PNP
Output function	NO
Operating voltage	10 to 36 V DC
Nominal range	5 mm
Operating temperature	-40 to +85 °C

Pipe

Length	2.5 or 5 m
Diameter	4 mm thin wall
Material	stainless steel, PTFE pipe holder

11. Spare parts and accessories



Only original SKF Lubrication Systems France SAS spare parts may be used. It is prohibited for the operator to make alterations to the product or to use non original spare parts and resources.

Table 15

Spare parts for kit CLK-460R-100

Order No.	Designation	Comments
UCDE01-460RT	Central unit	give the voltage key when ordering (→ table 2)
AC-A-420	Double nozzle with adjustable interaxial distance	
AC-5121	Proximity switch – Ø12	-40 to +85 °C (standard)
AC.4026.10	Power supply/connection kit Alimentation	
AC.2218	Fault output connector	
AC-4388	Connector proximity switch input	
UCDE01-TU0250	Kit stainless steel tube 316L length 2.5 m	
UCDE01-TU0500	Kit stainless steel tube 316L length 5 m	
SY-9736	Fixing clips for tube Ø12 (min. qty 5)	
BI.410	Double tapered sleeve for tube Ø4	only with RB.409.I
RB.409.I	Nut for tube Ø4	only with RB.410
SY-9729	Support plate	
SY-9730	Nozzle bracket support	
SY-9732	Intermediate support for proximity switch	
SY-9733	Proximity switch bracket support Ø12 and Ø8	
TK-1317	Reservoir plug	

Table 16

Spare parts for kit CLK-260R-100

Order No.	Designation	Comments
UCDE01-260RT	Central unit	give the voltage key when ordering (→ table 2)
AC-A-420	Double nozzle with adjustable interaxial distance	
AC-5121	Proximity switch – Ø12	-40 to +85 °C (standard)
AC.4026.10	Power supply/connection kit Alimentation	
AC.2218	Fault output connector	
AC-4388	Connector proximity switch input	
UCDE01-TU0500	Kit stainless steel tube 316L length 5 m	
SY-9736	Fixing clips for tube Ø12 (min. qty 5)	
BI.410	Double tapered sleeve for tube Ø4	only with RB.409.I
RB.409.I	Nut for tube Ø4	only with RB.410
SY-9729	Support plate	
SY-9730	Nozzle bracket support	
SY-9732	Intermediate support for proximity switch	
SY-9733	Proximity switch bracket support Ø12 and Ø8	
TK-1317	Reservoir plug	

Table 17

Spare parts for kit CLK-460R-110

Order No.	Designation	Comments
UCDE01-460RT	Central unit	give the voltage key when ordering (→ table 2)
AC-A-420	Double nozzle with adjustable interaxial distance	
UCDE01-100-HT	Proximity switch – Ø18	-25 to +180 °C (high temperature)
AC.4026.10	Power supply/connection kit Alimentation	
AC.2218	Fault output connector	
AC-4388	Connector proximity switch input	
UCDE01-TU0250	Kit stainless steel tube 316L length 2,5 m	
UCDE01-TU0500	Kit stainless steel tube 316L length 5 m	
SY-9736	Fixing clips for tube Ø12 (min. qty 5)	
BI.410	Double tapered sleeve for tube Ø4	only with RB.409.I
RB.409.I	Nut for tube Ø4	only with RB.410
SY-9729	Support plate	
SY-9730	Nozzle bracket support	
SY-9732	Intermediate support for proximity switch	
SY-9733-1	Proximity switch bracket support	
TK-1317	Reservoir plug	

Table 18

Spare parts for kit CLK-430R-101

Order No.	Designation	Comments
UCDE01-430RT	Central unit	give the voltage key when ordering (→ table 2)
AC-A-410	Simple nozzle	
AC-5121	Proximity switch – Ø12	-40 to +85 °C (standard)
AC.4026.10	Power supply/connection kit Alimentation	
AC.2218	Fault output connector	
AC-4388	Connector proximity switch input	
UCDE01-TU0250	Kit stainless steel tube 316L length 2.5 m	
UCDE01-TU0500	Kit stainless steel tube 316L length 5 m	
SY-9736	Fixing clips for tube Ø12 (min. qty 5)	
BI.410	Double tapered sleeve for tube Ø4	only with RB.409.I
RB.409.I	Nut for tube Ø4	only with RB.410
SY-9729	Support plate	
SY-9730	Nozzle bracket support	
SY-9732	Intermediate support for proximity switch	
SY-9733	Proximity switch bracket support Ø12 and Ø8	
TK-1317	Reservoir plug	

Table 19

Spare parts for kit CLK-430R-121

Order No.	Designation	Comments
UCDE01-430RT	Central unit	give the voltage key when ordering (→ table 2)
AC-A-410	Simple nozzle	
AC-5145	Proximity switch – Ø8	-40 to +85 °C (standard)
AC.4026.10	Power supply connection kit	
AC.2218	Fault output connector	
AC-4388	Connector proximity switch input	
UCDE01-TU0250	Kit stainless steel tube 316L length 2.5 m	
UCDE01-TU0500	Kit stainless steel tube 316L length 5 m	
SY-9736	Fixing clips for tube Ø12 (min. qty 5)	
BI.410	Double tapered sleeve for tube Ø4	only with RB.409.I
RB.409.I	Nut for tube Ø4	only with RB.410
SY-9729	Support plate	
SY-9730	Nozzle bracket support	
SY-9732	Intermediate support for proximity switch	
SY-9733	Proximity switch bracket support Ø12 and Ø8	
TK-1317	Reservoir plug	

List of accessories for CLK kits

Order No.	Designation	Comments
UCDE01-100-HTD30 AC-5145	Proximity switch – Ø30 Proximity switch – Ø8	0 to 180 °C (high temperature) –25 to +70 °C (small chain)
UCDE01-TU0250-AC UCDE01-TU0500-AC TU-3X4-IX WV-R04X0.7VERZI UC-1060-22-1	Kit steel tube length 2,5 m Kit steel tube length 5 m Stainless steel tube 316L Ø4x0,5 (per meter) Steel tube Ø4x0,7 (4 m bar) Proximity switch support, Ø30	Separated mounting from the SY-9729
UCDE01-CT-3-16	Tube cutter 3-16 mm	

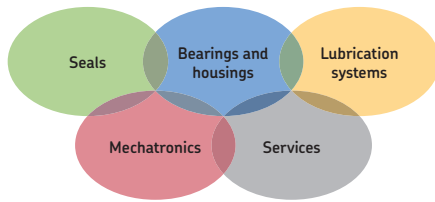

The Power of Knowledge Engineering

Combining products, people, and application-specific knowledge, SKF delivers innovative solutions to equipment manufacturers and production facilities in every major industry worldwide. Having expertise in multiple competence areas supports SKF Life Cycle Management, a proven approach to improving equipment reliability, optimizing operational and energy efficiency and reducing total cost of ownership.

These competence areas include bearings and units, seals, lubrication systems, mechatronics, and a wide range of services, from 3-D computer modelling to cloud-based condition monitoring and asset management services.

SKF's global footprint provides SKF customers with uniform quality standards and worldwide product availability. Our local presence provides direct access to the experience, knowledge and ingenuity of SKF people.

SKF Lubrication Systems France SAS

Bld Charles de Gaulle, B.P. 239

37540 St-Cyr-sur-Loire – FRANCE

Tel. +33 (0) 247 405 300 Fax +33 (0) 247 405 353

www.skf.com/lubrication

Important information on the use of products

All SKF products may be used strictly respecting the instructions described in this brochure or the operating instructions. If the operating instructions are supplied with the product, they must be read carefully and respected. None of the lubricants is compatible with the centralized lubrication systems! On the user's demand, SKF can check the compatibility of the lubricant chosen with the centralized lubrication systems. All products or their components manufactured by SKF are incompatible with the use of gas, liquefied gases, vaporized gas under pressure, vapors and any fluid with a vapor pressure greater than 0.5 bar at normal atmospheric pressure (1013 mbar) for the maximum permissible temperature. More specifically, we call your attention to the fact that hazardous products of any kind, especially products classified as hazardous by the EC Directive 67/548/EEC, Article 2, paragraph 2, can only be used to feed the SKF centralized lubrication systems, transported or distributed by these systems after consultation with SKF and obtaining written permission.

© SKF is a registered trademark of the SKF Group.

© SKF Group 2014

The contents of this publication are the copyright of the publisher and may not be reproduced (even extracts) unless prior written permission is granted. Every care has been taken to ensure the accuracy of the information contained in this publication but no liability can be accepted for any loss or damage whether direct, indirect or consequential arising out of the use of the information contained herein.

PUB 951-130-452/2 EN • November 2014

