

LP2 Lubrication Pinion  
for Lubrication of Open Girth Gears,  
Tooth Wheels and Gear Rods

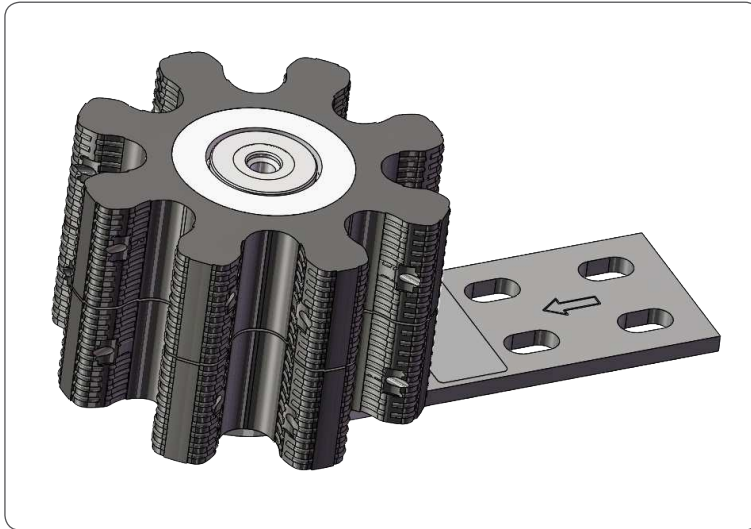

951-231-003-EN  
Version 03  
2018/01/15

## Legal disclosure

### Manufacturer

SKF Lubrication Systems Germany GmbH

### Manufacturer's facilities

Head Office

#### Walldorf Facilities

Heinrich-Hertz-Str. 2-8

69190 Walldorf

Germany

Phone +49 (0) 6227 33-0

Fax: +49 (0) 6227 33-259

#### Berlin Facilities

Motzener Straße 35/37

12277 Berlin

Germany

Phone +49 (0)30 72002-0

Fax +49 (0)30 72002-111

[www.skf.com/lubrication](http://www.skf.com/lubrication)

#### Hockenheim Facilities

2. Industriestraße 4

68766 Hockenheim

Germany

Phone +49 (0)62 05 27-0

Fax +49 (0)62 05 27-101

E-mail: [Lubrication-germany@skf.com](mailto:Lubrication-germany@skf.com)

[www.skf.com/lubrication](http://www.skf.com/lubrication)

### Training courses

In order to provide a maximum of safety and economic viability, SKF carries out detailed training courses. It is recommended that the training courses are attended. For more information please contact the respective SKF Service address.

### Copyright

© Copyright SKF

All rights reserved.

### Warranty

The instructions do not contain any information on the warranty. This can be found in our general terms and conditions.

### Disclaimer

The manufacturer shall not be held responsible for damages caused by:

- Non appropriate use  
faulty assembly, operation, setting, maintenance, repair or accidents
- Use of inappropriate lubricants
- Improper or late response to malfunctions
- Unauthorized modifications of the product
- Intent or negligence
- Use of non-original SKF spare parts.

Liability for loss or damage resulting from the use of our products is limited to the maximum purchase price. Liability for consequential damages of whatever kind is excluded.

























## Table of contents



Legal disclosure.....	2		
Explanation of symbols, signs and abbreviations.....	5		
<b>1. Safety instructions.....</b>	<b>7</b>	<b>2. Lubricants.....</b>	<b>16</b>
1.1 General safety instructions.....	7	2.1 General information.....	16
1.2 General behaviour when handling the product.....	7	2.2 Selection of lubricants.....	16
1.3 Intended use.....	8	2.3 Material compatibility.....	16
1.4 Foreseeable misuse.....	8	2.4 Temperature characteristics.....	16
1.5 Painting of plastic parts.....	8	2.5 Ageing of lubricants.....	17
1.6 Modifications of the product.....	9		
1.7 Other applicable documents.....	9	<b>3. Overview, functional description.....</b>	<b>18</b>
1.8 Application conditions to be avoided.....	9	3.1 Lubrication pattern.....	20
1.9 Installation and operating conditions to be avoided.....	10		
1.10 Notes related to the type identification plate.....	11	<b>4. Technical data.....</b>	<b>21</b>
1.11 Persons authorized to operate the pump.....	12	4.1 Type identification code of the lubrication pinion LP2.....	22
1.11.1 Operator.....	12	4.2 Installation dimensions of lubrication pinion LP2.....	23
1.11.2 Specialist in mechanics.....	12	4.3 Tightening torques.....	26
1.11.3 Specialist in electrics.....	12	4.4 Tightening torques.....	27
1.12 Briefing of external technicians.....	12	4.5 Lubrication pinion LP2, without bracket.....	28
1.13 Provision of personal protective equipment.....	12	4.5.1 Bore to mount the lubrication pinion.....	28
1.14 Operation.....	12	4.5.2 Tightening torque of the axle adapter.....	28
1.15 Emergency stopping.....	12		
1.16 Transport, installation, maintenance, malfunctions, repair, shutdown, disposal.....	13	<b>5. Delivery, returns, and storage.....</b>	<b>29</b>
1.17 Initial commissioning / daily start-up.....	14	5.1 Delivery.....	29
1.18 Cleaning.....	14	5.2 Returns.....	29
1.19 Residual risks.....	15	5.3 Storage.....	29
		5.4 Storage temperature range.....	29

<b>6.</b>	<b>Installation</b> .....	<b>30</b>	<b>12.</b>	<b>Repairs</b> .....	<b>40</b>
6.1	General information .....	30			
6.2	Place of installation .....	30	<b>13.</b>	<b>Shutdown and disposal</b> .....	<b>41</b>
6.3	Fastening material .....	30	13.1	Temporary shutdown .....	41
6.4	Installation of the lubrication pinion .....	31	13.2	Final shutdown and disassembly .....	41
6.5	Filling of the lubrication pinion .....	33	13.3	Disposal .....	41
6.6	Lubrication line connection .....	34			
<b>7.</b>	<b>Initial start-up</b> .....	<b>35</b>	<b>14.</b>	<b>Spare parts</b> .....	<b>42</b>
7.1	Inspections prior to initial start-up .....	35			
7.2	Inspections during initial start-up .....	35			
<b>8.</b>	<b>Operation</b> .....	<b>36</b>			
<b>9.</b>	<b>Cleaning</b> .....	<b>37</b>			
9.1	Cleaning agents .....	37			
9.2	Exterior cleaning .....	37			
9.3	Interior cleaning .....	37			
<b>10.</b>	<b>Maintenance</b> .....	<b>38</b>			
<b>11.</b>	<b>Troubleshooting</b> .....	<b>39</b>			

## Explanation of symbols, signs and abbreviations

The following abbreviations may be used within these instructions. Symbols within safety notes mark the kind and source of the hazard.

	General warning		Dangerous electrical voltage		Risk of falling		Hot surfaces
	Unintentional intake		Crushing hazard		Pressure injection		Suspended load
	Electrostatically sensitive components		Potentially explosive atmosphere		Wear personal protective equipment (gloves)		Wear personal protective equipment (protective clothes)
	Wear personal protective equipment (goggles)		Wear personal protective equipment (face shield)		General obligation		
	Wear personal protective equipment (safety shoes)		Disconnect product from mains		Safety extra-low voltage (SELV)		
	Keep unauthorized persons away		Protective earth		Disposal of waste electrical and electronic equipment		Safe galvanic isolation (SELV)
	CE marking		Disposal, recycling				

	Warning level	Consequence	Probability	Symbol	Meaning
	<b>DANGER</b>	Death, serious injury	imminent	●	Chronological guidelines
	<b>WARNING</b>	Death, serious injury	possible	○	Lists
	<b>CAUTION</b>	Minor injury	possible	☞	Refers to other facts, causes, or consequences
	<b>NOTICE</b>	Property damage	possible		

## Abbreviations and conversion factors

re.	regarding	°C	degrees Celsius	°F	degrees Fahrenheit
approx.	approximately	K	Kelvin	Oz.	ounce
i.e.	that is	N	Newton	fl. oz.	fluid ounce
etc.	et cetera	h	hour	in.	inch
poss.	possibly	s	second	psi	pounds per square inch
if appl.	if applicable	d	day	sq.in.	square inch
a.a.r.	as a rule	Nm	Newtonmeter	cu. in.	cubic inch
incl.	including	ml	millilitre	mph	miles per hour
min.	minimum	ml/d	millilitre per day	rpm	revolutions per minute
max.	maximum	cc	cubic centimetre	gal.	gallon
min.	minute	mm	millimetre	lb.	pound
etc.	et cetera	l	litre	hp	horse power
e.g.	for example	dB (A)	sound pressure level	kp	kilopound
kW	kilowatt	>	greater than	fpsec	feet per second
U	voltage	<	less than	conversion factors	
R	resistance	±	plus/minus	Length	1 mm = 0.03937 in.
I	current	∅	diameter	Area	1 cm <sup>2</sup> = 0.155 sq.in
V	volt	kg	kilogram	Volume	1 ml = 0.0352 fl.oz.
W	watt	rh	relative humidity		1 l = 2.11416 pints (US)
AC	alternating current	≈	approximately	Mass	1 kg = 2.205 lbs
DC	direct current	=	equal to		1 g = 0.03527 oz.
A	ampere	%	per cent	Density	1 kg/cc = 8.3454 lb./gal(US)
Ah	ampere hour	‰	per mille		1 kg/cc = 0.03613 lb./cu.in.
Hz	frequency [Hertz]	≥	greater than	Force	1 N = 0.10197 kp
nc	normally closed contact	≤	less than	Pressure	1 bar = 14.5 psi
no	normally open contact	mm <sup>2</sup>	square millimetre	Temperature	°C = (°F - 32) x 5/9
		rpm <sup>-1</sup>	revolutions per minute	Output	1 kW = 1.34109 hp
				Acceleration	1 m/s <sup>2</sup> = 3.28084 ft./s <sup>2</sup>
				Speed	1 m/s = 3.28084 fpsec.
					1 m/s = 2.23694 mph

# 1. Safety instructions

## 1.1 General safety instructions

- The owner must ensure that safety information has been read by any persons entrusted with works on the product or by those persons who supervise or instruct the before-mentioned group of persons. In addition, the owner must also ensure that the relevant personnel are fully familiar with and have understood the contents of the Instructions. It is prohibited to commission or operate the product prior to reading the Instructions.
- These Instructions must be kept for further use.
- The described products were manufactured according to the state of the art. Risks may, however, arise from a usage not according to the intended purpose and may result in harm to persons or damage to material assets.
- Any malfunctions which may affect safety must be remedied immediately. In addition to these Instructions, general statutory regulations for accident prevention and environmental protection must be observed.

## 1.2 General behaviour when handling the product

- The product may be used only in awareness of the potential dangers, in proper technical condition, and according to the information in these instructions.
- Familiarize yourself with the functions and operation of the product. The specified assembly and operating steps and their sequences must be observed.
- Any unclear points regarding proper condition or correct assembly/ operation must be clarified. Operation is prohibited until issues have been clarified.
- Keep unauthorized persons away
- Wear personal protective equipment always.
- Precautionary operational measures and instructions for the respective work must be observed.
- Responsibilities for different activities must be clearly defined and observed. Uncertainty seriously endangers safety.
- Safety-related protective and safety equipment must not be removed, modified or affected otherwise in its function and is to be checked at regular intervals for completeness and function.
- If protective and safety equipment has to be dismantled, it must be reassembled immediately after finishing the work, and then checked for correct function.
- Remedy occurring faults in the frame of responsibilities. Immediately inform your superior in the case of faults beyond your competence.
- Never use parts of the centralized lubrication system or of the machine as standing or climbing aids.

### 1.3 Intended use

Application of lubricant on tooth flanks of straight geared tooth wheels, girth gears and gear rods in open gear drives to minimize wear. Application is allowed only within the specifications, technical data and limits stated in these instructions as well as in the frame of a commercial, economic activity by a professional user.

### 1.4 Foreseeable misuse

Any usage differing from the one stated in these Instructions is strictly prohibited, particularly a usage:

- outside the indicated operating temperature range
- to lubricate helically geared tooth wheels, girth gears and gear rods
- to lubricate gear belts or chains
- with tooth wheels, girth gears and gear rods having a module different from the lubrication pinion
- with tooth wheels, girth gears and gear rods with inadequate tooth depth
- with tooth wheels, girth gears and gear rods damaged on the surface (e. g. strong

scoring, cracked or sharp edges) or seriously contaminated with solids

- with non-specified means of operation
- within hygiene zones of machines used in the food and luxury food industry
- to supply, transport, or store hazardous substances and mixtures in accordance with annex I part 2-5 of the CLP regulation (EG 1272/2008) and marked with GHS01 - GHS06 and GHS08 hazard pictograms.
- to feed, forward, or store gases, liquefied gases, dissolved gases, vapours, or fluids whose vapour pressure exceeds normal atmospheric pressure (1013 mbar) by more than 0.5 bar at the maximum permissible operating temperature.
- in an explosion protection zone.

### 1.5 Painting of plastic parts

Painting of any plastic parts or seals of the described products is expressly prohibited. Remove or tape plastic parts completely before painting the superior machine



### 1.6 Modifications of the product

Unauthorized conversions or modifications may result in unforeseeable impacts on safety. Therefore, any unauthorized conversions or modifications are expressly prohibited.

#### 1.7 Other applicable documents

In addition to these instructions, the following documents must be observed by the respective target group:

- Safety data sheet of the lubricant used
- The instructions of the pump that is used
- Operational instructions and release provisions provided by the operator

Where appropriate:

- Project planning documents
- Instructions of the suppliers of purchased parts

The operator must supplement these documents with the relevant applicable national regulations of the country of use. When selling or forwarding the product, make sure to attach these instructions to it.

### 1.8 Application conditions to be avoided

The suitability of a plastic for a certain application also depends on its resistance to chemicals and physical exposure at the place of use. The following burdens shall be avoided as they may result in an irreversible damage of the lubrication pinion with a premature functional loss.

#### Acids and alkalis

Strong acids and alkalis start attacking PU products already at room temperature. A contact with these substances should be avoided.

#### Aromatic hydrocarbons

Aromatic hydrocarbons like, e. g. benzene, cause considerable swelling of the PU material.

#### Alcohols, ketones and esters

Alcohols such as ethanol or isopropanol, ketones such as acetone and esters cause considerable swelling of the PU material.

#### Water, saturated steam or tropical climate

Long-term operation or storage with water contact (especially salt water), saturated steam or in tropical climate will result in an irreversible damage due to hydrolysis. Therefore, make sure to avoid longer direct water contact (especially salt water).

#### Ozone and UV radiation

Our PU lubrication pinions have a good resistance to ozone and UV radiation. Depending on the concentration and other conditions of use the lubrication pinions should be checked for cracks at regular intervals.

### 1.9 Installation and operating conditions to be avoided

The following installation and operating conditions shall be avoided, as otherwise the lubrication pinion or the component to be lubricated may be damaged.

- Dry run after installation. Prime the lubrication pinion with lubricant and, if necessary, also lubricate the component to be lubricated.
- Provision of the lubrication pinion with lubricant in case of a downtime.
- Overriding of gear rods, i. e. the lubrication pinion is no more engaged.
- Use lubrication pinions that are significantly broader ( $> 1/3$ ) or considerably narrower ( $< 2/3$ ) than the component to be lubricated.
- Lubrication of several gear rods positioned in parallel by one lubrication pinion only.
- Oscillating movements that are smaller than the lubrication pinion's diameter. In this case an application of lubricant is no longer possible.

- In case of oscillating movements the lubrication pinion must be mounted as close to the friction point as possible. It must be ensured that the lubricant applied reaches the friction points.
- Mounting of lubrication pinion and component to be lubricated to bearings moveable against one another (e. g. carrier systems, damping systems that are moveable against one another). Such mounting can result in inadmissibly serious deviations of the track alignment and also in a damage to the lubrication pinion because of too high contact pressure.
- Installation of the lubrication pinion should take place at the expected operating temperature. Strong deviations may

result in an increased or reduced contact pressure outside of the permitted range. Therefore, in case of affected machines or vehicles (summer/ winter operation) check and, if necessary, adapt the contact pressure.

### 1.10 Notes related to the type identification plate

The type identification plate states important characteristics such as type designation, order number, and regulatory characteristics.

To ensure that the loss of data due to an illegible type identification plate is avoided, the characteristics should be entered in the Instructions.

Model: \_\_\_\_\_

P. No. \_\_\_\_\_

S. No. \_\_\_\_\_

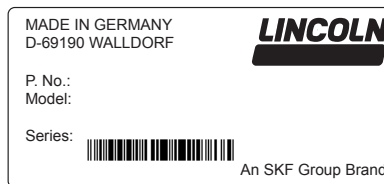

## 1.11 Persons authorized to operate the pump

### 1.11.1 Operator

A person who is qualified by training, knowledge and experience to carry out the functions and activities related to normal operation. This includes avoiding possible hazards that may arise during operation.

### 1.11.2 Specialist in mechanics

Person with appropriate professional education, knowledge and experience to detect and avoid the hazards that may arise during transport, installation, start-up, operation, maintenance, repair and disassembly.

### 1.11.3 Specialist in electrics

Person with appropriate professional education, knowledge and experience to detect and avoid the hazards that may arise from electricity.

## 1.12 Briefing of external technicians

Prior to commencing the activities, external technicians must be informed by the operator of the company safety provisions, the applicable accident prevention regulations to be maintained, and the functions of the superordinate machine and its protective devices.

## 1.13 Provision of personal protective equipment

The operator must provide suitable personal protective equipment for the respective location of operation and the purpose of operation.

## 1.14 Operation

The following must be observed during commissioning and operation.

- Any information within this manual and the information within the referenced documents
- All laws and regulations to be complied with by the user

## 1.15 Emergency stopping

In case of an emergency stop the pump station by:

- Interrupting the power supply to the superordinate machine
- Where appropriate, using measures determined by the operator, such as actuating the emergency stop switch of the superior machine

### 1.16 Transport, installation, maintenance, malfunctions, repair, shutdown, disposal

- All relevant persons must be informed of the activity prior to starting any work. Observe the precautionary operational measures and work instructions.
- Maintenance and repair work can be subject to restrictions at low or high temperatures (e.g. changed flow properties of the lubricant). Therefore, where possible, try to carry out maintenance and repair work at room temperature.
- Prior to performing work, depressurize and switch off the machine, into which the product will be integrated, and secure it against unauthorized activation.
- Ensure through suitable measures that movable or detached parts are immobilized during the work and that no limbs can be caught in between by inadvertent movements.
- Dry or cover wet, slippery surfaces accordingly.
- Cover hot or cold surfaces accordingly.
- Install the product at an adequate distance from sources of heat or cold. Other units of the machine or vehicle must not be damaged or impaired in their function by the installation.
- Undertake drilling at non-critical, non-load bearing parts only. Use any available boreholes. Do not damage lines and cables when drilling.
- All components used must be designed according to the maximum operating pressure and the maximum respectively minimum operating temperature.
- Check all parts prior to their usage for contamination and damage.
- Lubricant lines should be primed with lubricant prior to installation.
- Observe the specified tightening torques. When tightening, use a calibrated torque wrench.

### 1.17 Initial commissioning / daily start-up

Ensure that:

- All safety devices of the superordinate machine are completely available and functional
- All connections are correctly connected
- All parts are correctly installed

### 1.18 Cleaning

- Risk of fire and explosion when using inflammable cleaning agents Only use non-flammable cleaning agents suitable for the purpose.
- Do not use aggressive cleaning agents.
- Thoroughly remove residues of cleaning agents from the product.
- Do not use steam jet and high pressure cleaners. The lubrication pinion could be damaged.
- Mark damp areas accordingly.

## 1.19 Residual risks

Residual risk	Possible in life cycle											Prevention/ remedy	
Personal injury/ material damage due to falling of raised parts	A	B	C					G	H	K			Keep unauthorized persons away No people may remain under suspended loads. Lift parts with adequate lifting devices.
Personal injury/ material damage due to tilting or falling of the product because of non-observance of the stated tightening torques		B	C					G					Observe the specified tightening torques. Fix the product only to components with sufficient load capacity. If no tightening torques are stated, apply tightening torques according to the screw size characteristics for 8.8 screws or higher.
Personal injury/ damage to material due to spilled or leaked lubricant		B	C	D		F	G	H	K				Be careful when filling, connecting or disconnecting lubricant feed lines. Always use suitable hydraulic screw connections and lubrication lines for the stated pressures. Do not mount lubrication lines to moving parts or friction points. If this cannot be avoided, use spring coils respectively protective conduits.
Unintended intake, crushing or shearing of fingers and limbs caused by a contact with the tooth wheel, girth gear or gear rod.		B	C	D	E	F	G						Never touch the lubrication pinions or other moving or rotating parts while the machine is operating. Before carrying out any work on these parts, switch the machine off and secure it against unauthorised restart.

Life phases:

A = transport, B = installation, C = initial start-up, D = operation, E = cleaning, F = maintenance, G = fault, repair, H = shutdown, K = disposal

## 2. Lubricants

### 2.1 General information

Lubricants are used specifically for certain application purposes. In order to fulfil their tasks, lubricants must fulfil various requirements.

The most important requirements for lubricants are:

- Reduction of abrasion and wear
- Corrosion protection
- Noise minimisation
- protection against contamination or penetration of foreign objects
- Cooling (primarily with oils)
- longevity (physical/ chemical stability)
- economic and ecological aspects

### 2.2 Selection of lubricants

SKF considers lubricants to be an element of system design. A suitable lubricant is selected already when designing the machine and forms the basis for the planning of a centralized lubrication system.

The selection is made by the manufacturer or operator of the machine, preferably together with the lubricant supplier based on the requirement profile defined.

Should you have little or no experience with the selection of lubricants for centralized lubrication systems, please contact SKF.

If required we will be glad to support customers to select suitable components for feeding the selected lubricant and to plan and design their centralized lubrication system.

You will avoid possible downtimes through damage to your machine or system or damage to the centralized lubrication system.

### 2.3 Material compatibility

Lubricants must generally be compatible with the following materials:

- steel, grey iron, brass, copper, aluminium
- NBR, FPM, ABS, PA, PU

### 2.4 Temperature characteristics

The lubricant used must be suitable for the specific operating temperature of the product. The viscosity required for proper operation of the product must be adhered to and must not be exceeded in case of low temperatures nor fall below specification in case of high temperatures. Specified viscosities, see chapter Technical data.



### 2.5 Ageing of lubricants

After a prolonged downtime of the machine, the lubricant must be inspected prior to re-commissioning as to whether it is still suitable for use due to chemical or physical ageing. We recommend that you undertake this inspection already after a machine downtime of 1 week.

If doubts arise as to a further suitability of the lubricant, please replace it prior to re-commissioning and, if necessary, undertake initial lubrication by hand.

It is possible for lubricants to be tested in the company's laboratory for their suitability for being pumped in centralized lubrication systems (e.g. "bleeding").

Please contact SKF, if you have further questions regarding lubricants.

You may request an overview of the lubricants tested by SKF.



Only lubricants specified for the product (see chapter Technical data) may be used. Unsuitable lubricants may lead to a failure of the product.



Do not mix lubricants. This may have unforeseeable effects on the usability and therefore on the function of the centralized lubrication system.



When handling lubricants the relevant safety data sheets and hazard designations, if any, on the packaging have to be observed.



Due to the multitude of possible additives, individual lubricants, which according to the manufacturer's data sheets fulfil the necessary specification, may not, in fact, be suitable for use in centralized lubrication systems (e. g. incompatibility between synthetic lubricants and materials). In order to avoid this, always use lubricants tested by SKF.

### 3. Overview, functional description

#### 1 Lubrication pinion

The lubrication pinion with comb profile provides the lubricant ducts for application of the lubricant. Of these eight lubricant ducts only one is active at a time. In the tooth the lubricant duct divides in such way that lubricant is dispensed to both tooth flanks. The active lubricant duct is the one which is positioned in the direction of the arrow at that time.

#### 2 Axis

The axis guides the lubrication pinion and includes the two connectors G1/8 for the lubrication line. Both connectors G1/8 may be used for connection of the lubrication lines.

#### 3 Bracket

The bracket is used to fasten the lubrication pinion to the superordinate machine. The bracket is provided with 4 slotted holes for flexible adaptation to the respective installation position. Furthermore, the type identification position and an arrow (4) are positioned on the mounting lug. This arrow (4) marks the direction of the active lubricant duct.

Overview Fig. 1

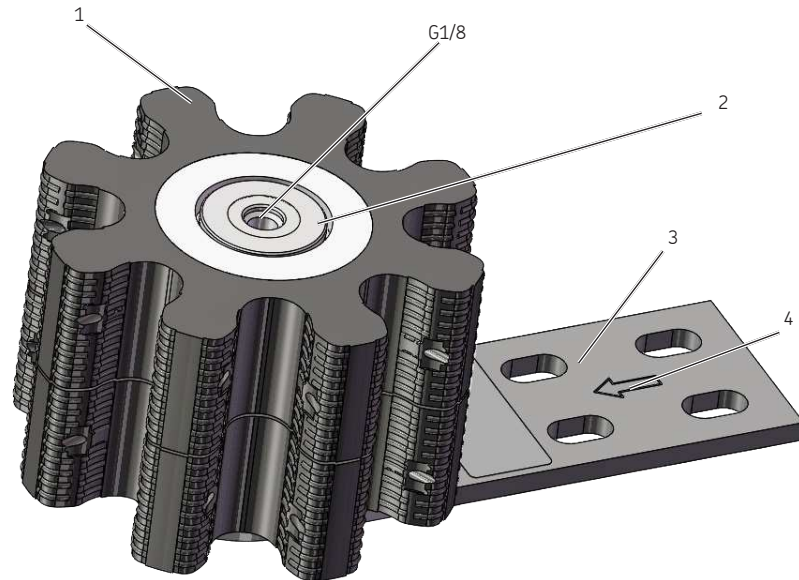

**Functional description**

Whenever the lubrication pump supplies lubricant, the lubricant is dispensed into the axis of the lubrication pinion via the lubrication line. The lubricant is applied onto the tooth flanks of the component to be lubricated via the active lubricant duct (A). All lubricant ducts that are not engaged (B-H) are inactive. The active lubricant duct is positioned in the direction of the arrow (4.1) always.

Functional description Fig. 2

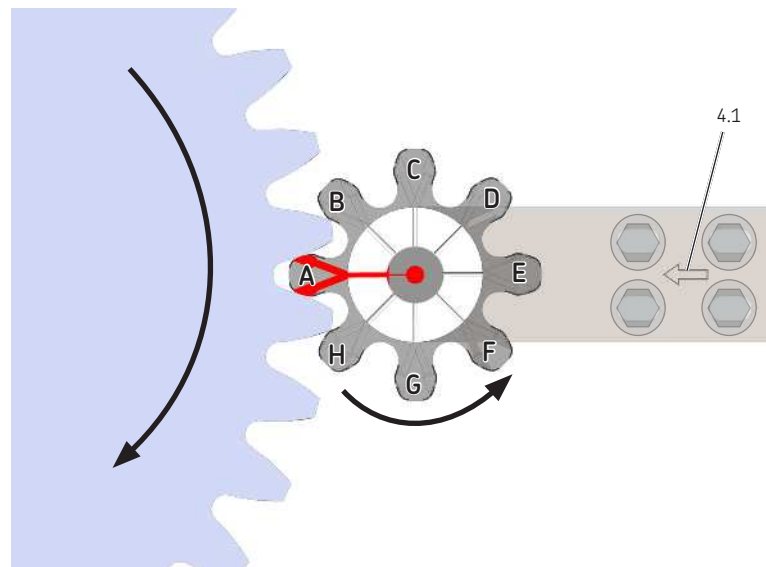

### 3.1 Lubrication pattern

The lubrication pattern on the component to be lubricated should be visible as evenly as possible over the entire tooth flanks' area. In case of major deviations of the lubrication pattern the contact pressure, the track alignment and the output must be checked and corrected on the lubrication pump, if required.



Depending on the lubrication pump control the complete development of a lubrication pattern may take a longer time. Therefore, in case of wear- or corrosion-sensitive components, these must be pre-lubricated by hand.

Optimum lubrication pattern Fig. 3

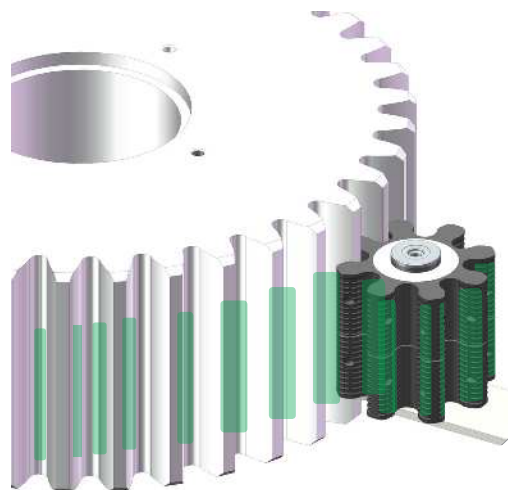

## 4. Technical data

Admissible operating temperature range of the lubrication pinions -30 °C to +70 °C



The indicated operating temperature range presupposes the suitability of the lubricant used for the respective actually existing operating temperature. Using an unsuitable lubricant may result in malfunctions and even in a downtime. Failure caused by lubricant may occur temporarily, e. g. if the application temperature limit is exceeded or is not reached.

Approved lubricants	Lubrication grease up to NLGI 2 <sup>2)</sup>
Max. admissible volume flow	2.0 l/min <sup>1)</sup>
Max. admissible inlet pressure	150 bar
Installation position / rotational direction	any
Maximum speed	80 rpm <sup>2)</sup>
Connection for lubrication line	G1/8
Number of teeth	8
Module	12 / 14 / 16 / 18 / 20 / 22 / 24 / 30
Material	PU (polyurethane)
Admissible material pairing of the lubrication pinion and the component to be lubricated	PU / metal
Durability in case of intended use	min. 1,000,000 revolutions
Maximum eccentricity of the component to be lubricated	1 mm
Deviation of the alignment of the axis of the lubrication pinion and the component to be lubricated	± 1 °
Active lubricant duct	↔ in the direction of the arrow (indicated on the bracket)
Permanent operation / intermittent operation	YES / YES



A permanent operation of the pump with the lubrication pinion being idle should be avoided, as otherwise the lubrication pinion may be damaged.

<sup>1)</sup> In case of compliance with the maximum admissible volume flow no inadmissibly high pressures will be generated in the lubrication pinion.

<sup>2)</sup> Select a lubricant that has no tendency to be thrown out at the expected speed and temperatures.

#### 4.1 Type identification code of the lubrication pinion LP2

The type identification code facilitates selection/ identification of important features of the product. See type identification plate of product for specific type identification code. The duration of the corrosion protection does not stand for the warranty period.

Structure of the type identification code											
LP2	-	3	4	-	1	2	-	D	H	1	Example
A	B	C		D				E <sup>3)</sup>	F		Category
<b>A   Product designation</b>											
LP2											
<b>B   Corrosion protection class</b>											
3 = C3-L      Term of protection ≥ 15 years											
5 = C5-M-L    Term of protection ≥ 15 years											
<b>C   Module</b>											
2 = Module 12    Width of lubrication pinion 08 - 14											
3 = Module 14    Width of lubrication pinion 08 - 14											
4 = Module 16    Width of lubrication pinion 10 - 16											
5 = Module 18    Width of lubrication pinion 10 - 16											
6 = Module 20    Width of lubrication pinion 12 - 20											
7 = Module 22    Width of lubrication pinion 14 - 22											
8 = Module 24    Width of lubrication pinion 14 - 24											
9 = Module 30    Width of lubrication pinion 20 - 30											
<b>D   Width of lubrication pinion [mm]</b>											
08 = 80			14 = 140			20 = 200			26 = 260		
09 = 90			15 = 150			21 = 210			27 = 270		
10 = 100			16 = 160			22 = 220			28 = 280		
11 = 110			17 = 170			23 = 230			29 = 290		
12 = 120			18 = 180			24 = 240			30 = 300		
13 = 130			19 = 190			25 = 250					

<b>E   Fittings</b>
H = Inlet closed with closure screw
Z = Inlet open - delivered without closure screw
A = Push-in type fitting Ø 6
B = Elbow tube fitting 90° Ø 6
C = Straight tube fitting E02 Ø 6
D = Straight tube fitting E02 Ø 8
E = Straight tube fitting E02 Ø 10
F = Adapter for inlet G <sup>1</sup> / <sub>4</sub>
G = Adapter for inlet G <sup>3</sup> / <sub>8</sub>
<b>F   Bracket for lubrication pinion</b>
0 = Lubrication pinion without bracket
1 = Lubrication pinion with bracket

<sup>3)</sup>The first one of the two values defines the type of fitting at the inlet on the side of the bracket, the second value defines the type of fitting at the inlet opposite the bracket.

## 4.2 Installation dimensions of lubrication pinion LP2

In the following please find the installation dimensions of the LP2 lubrication pinions described in these instructions. The individual LP2 lubrication pinions can be identified via the type identification code characteristics Module (M) and Width (B) (see chapter Type identification code).

Version of the lubrication pinion						Dimensions [mm]					
Type			M	B		A	B	C	D	E	F
L P 2	-	X 2	-	0 8	-	80	91	160	112	30	60
L P 2	-	X 2	-	0 9	-	90	102	160	112	30	60
L P 2	-	X 2	-	1 0	-	100	111	160	112	30	60
L P 2	-	X 2	-	1 1	-	110	122	160	112	30	60
L P 2	-	X 2	-	1 2	-	120	132	160	112	30	60
L P 2	-	X 2	-	1 3	-	130	142	160	112	30	60
L P 2	-	X 2	-	1 4	-	140	152	160	112	30	60
L P 2	-	X 3	-	0 8	-	80	91	160	126	30	60
L P 2	-	X 3	-	0 9	-	90	102	160	126	30	60
L P 2	-	X 3	-	1 0	-	100	111	160	126	30	60
L P 2	-	X 3	-	1 1	-	110	122	160	126	30	60
L P 2	-	X 3	-	1 2	-	120	132	160	126	30	60
L P 2	-	X 3	-	1 3	-	130	142	160	126	30	60
L P 2	-	X 3	-	1 4	-	140	152	160	126	30	60
L P 2	-	X 4	-	1 0	-	100	111	160	144	30	60
L P 2	-	X 4	-	1 1	-	110	122	160	144	30	60
L P 2	-	X 4	-	1 2	-	120	132	160	144	30	60
L P 2	-	X 4	-	1 3	-	130	142	160	144	30	60
L P 2	-	X 4	-	1 4	-	140	152	160	144	30	60
L P 2	-	X 4	-	1 5	-	150	162	160	144	30	60
L P 2	-	X 4	-	1 6	-	160	172	160	144	30	60

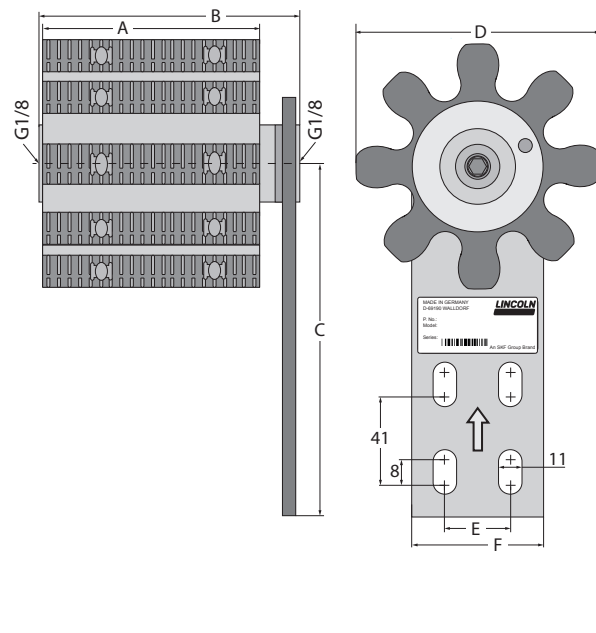

Version of the lubrication pinion								Dimensions [mm]							
Type				M		B		A	B	C	D	E	F		
L	P	2	-	X	5	-	1	0	-	100	111	160	162	30	60
L	P	2	-	X	5	-	1	1	-	110	122	160	162	30	60
L	P	2	-	X	5	-	1	2	-	120	132	160	162	30	60
L	P	2	-	X	5	-	1	3	-	130	142	160	162	30	60
L	P	2	-	X	5	-	1	4	-	140	152	160	162	30	60
L	P	2	-	X	5	-	1	5	-	150	162	160	162	30	60
L	P	2	-	X	5	-	1	6	-	160	172	160	162	30	60
L	P	2	-	X	6	-	1	2	-	120	133	195	180	60	90
L	P	2	-	X	6	-	1	3	-	130	144	195	180	60	90
L	P	2	-	X	6	-	1	4	-	140	154	195	180	60	90
L	P	2	-	X	6	-	1	5	-	150	164	195	180	60	90
L	P	2	-	X	6	-	1	6	-	160	174	195	180	60	90
L	P	2	-	X	6	-	1	7	-	170	184	195	180	60	90
L	P	2	-	X	6	-	1	8	-	180	193	195	180	60	90
L	P	2	-	X	6	-	1	9	-	190	204	195	180	60	90
L	P	2	-	X	6	-	2	0	-	200	214	195	180	60	90
L	P	2	-	X	7	-	1	4	-	140	154	195	198	60	90
L	P	2	-	X	7	-	1	5	-	150	164	195	198	60	90
L	P	2	-	X	7	-	1	6	-	160	174	195	198	60	90
L	P	2	-	X	7	-	1	7	-	170	184	195	198	60	90
L	P	2	-	X	7	-	1	8	-	180	194	195	198	60	90
L	P	2	-	X	7	-	1	9	-	190	204	195	198	60	90
L	P	2	-	X	7	-	2	0	-	200	214	195	198	60	90
L	P	2	-	X	7	-	2	1	-	210	223	195	198	60	90
L	P	2	-	X	7	-	2	2	-	220	234	195	198	60	90

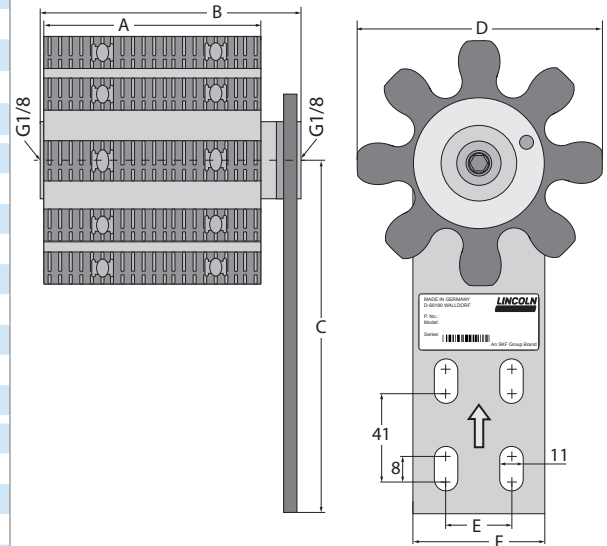



Version of the lubrication pinion						Dimensions [mm]					
Type			M	B	A	B	C	D	E	F	
L P 2 - X 8 - 1 4 -	140	154	195	216	60	90					
L P 2 - X 8 - 1 5 -	150	164	195	216	60	90					
L P 2 - X 8 - 1 6 -	160	174	195	216	60	90					
L P 2 - X 8 - 1 7 -	170	184	195	216	60	90					
L P 2 - X 8 - 1 8 -	180	194	195	216	60	90					
L P 2 - X 8 - 1 9 -	190	204	195	216	60	90					
L P 2 - X 8 - 2 0 -	200	214	195	216	60	90					
L P 2 - X 8 - 2 1 -	210	223	195	216	60	90					
L P 2 - X 8 - 2 2 -	220	234	195	216	60	90					
L P 2 - X 8 - 2 3 -	230	244	195	216	60	90					
L P 2 - X 8 - 2 4 -	240	254	195	216	60	90					
L P 2 - X 9 - 2 0 -	200	214	222	270	60	90					
L P 2 - X 9 - 2 1 -	210	223	222	270	60	90					
L P 2 - X 9 - 2 2 -	220	234	222	270	60	90					
L P 2 - X 9 - 2 3 -	230	244	222	270	60	90					
L P 2 - X 9 - 2 4 -	240	254	222	270	60	90					
L P 2 - X 9 - 2 5 -	250	264	222	270	60	90					
L P 2 - X 9 - 2 6 -	260	274	222	270	60	90					
L P 2 - X 9 - 2 7 -	270	284	222	270	60	90					
L P 2 - X 9 - 2 8 -	280	293	222	270	60	90					
L P 2 - X 9 - 2 9 -	290	304	222	270	60	90					
L P 2 - X 9 - 3 0 -	300	314	222	270	60	90					

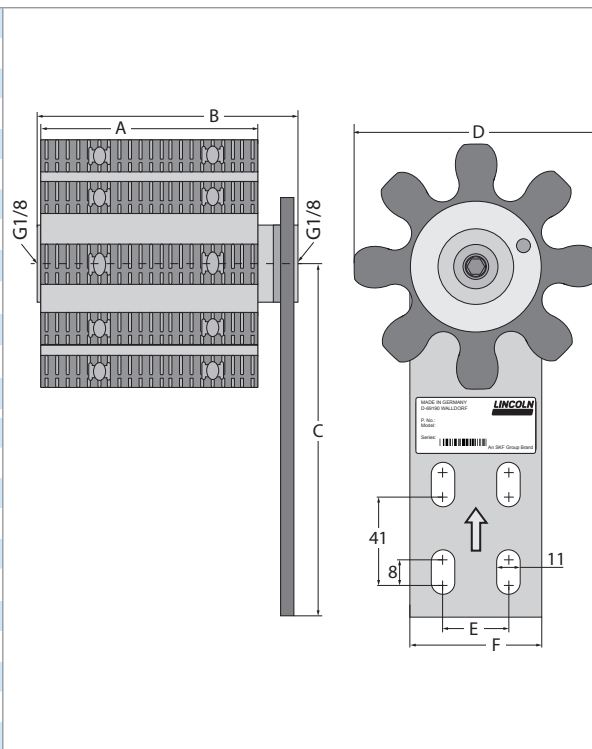

## 4.3 Tightening torques

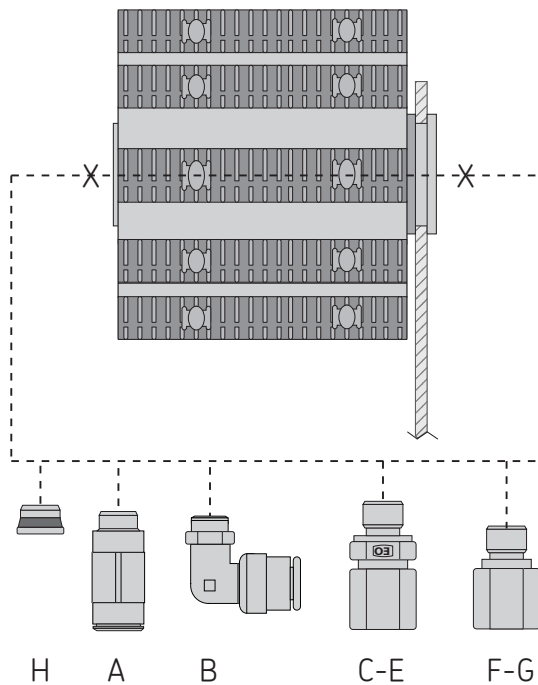

#### 4.4 Tightening torques

Code	Designation	Tightening torques		
		5	± 0.5	Nm
H	Closure screw	10	± 1.0	Nm
A	Push-in type fitting Ø 6	10	± 1.0	Nm
B	Elbow tube fitting 90° Ø 6	10	± 1.0	Nm
C	Straight tube fitting E02 Ø 6	18	± 1.8	Nm
D	Straight tube fitting E02 Ø 8	18	± 1.8	Nm
E	Straight tube fitting E02 Ø 10	18	± 1.8	Nm
F	Adapter G1/8 to G1/4	18	± 1.8	Nm
G	Adapter G1/8 to G3/8	18	± 1.8	Nm

#### 4.5 Lubrication pinion LP2, without bracket

If lubrication pinions are ordered without bracket, the user himself has to design a bracket. In this context, observe the following points:

- The bracket must suit the mechanical and corrosive loads arising at the place of use.
- The bore required for mounting the lubrication pinion must correspond to the dimensions indicated on the right.
- The middle of the groove (C) defines the direction of the active lubrication duct of the lubrication pinion.

The type identification plate included with the product should be fixed to the bracket. In addition, an arrow should be positioned on the bracket to make the direction of the active lubrication duct visible also for third parties. Thereby, the arrow must always point to the middle of the groove (C).



##### 4.5.1 Bore to mount the lubrication pinion

Bracket for modules 12 - 18	Bracket for modules 20 - 30

##### 4.5.2 Tightening torque of the axle adapter

Modules 12- 18	Modules 20- 30
G 3/8	G 1/2
$20 \pm 2$ Nm	$40 \pm 2$ Nm

Remove the adapter (B) loosely mounted in the lubrication pinion and position the lubrication pinion with its axis in the bore of the bracket, then secure the adapter with Loctite 638 and mount it with the specified tightening torque.

## 5. Delivery, returns, and storage

### 5.1 Delivery

After receipt of the shipment, check the shipment for damage and completeness according to the shipping documents. Immediately report any transport damages to the forwarding agent.

Keep the packaging material until any discrepancies are resolved. During in-house transport ensure safe handling.

### 5.2 Returns

Clean all parts and pack them properly (i.e. following the regulations of the recipient country) before returning them.

Protect the product against mechanical influences such as impacts. There are no restrictions for land, sea or air transport.

Mark returns on the packaging as follows.



### 5.3 Storage

SKF products are subject to the following storage conditions:

- dry, dust- and vibration-free in closed premises
- no corrosive, aggressive materials at the place of storage (e. g. UV rays, ozone)
- protected against pests and animals (insects, rodents, etc.)
- possibly in the original product packaging
- shielded from nearby sources of heat and coldness
- in case of high temperature fluctuations or high humidity take adequate measures (e. g. heater) to prevent the formation of condensation water.



Before application inspect the products with regard to possible damages occurred during their storage. This particularly applies for parts made out of plastic and rubber (embrittlement).

### 5.4 Storage temperature range

- In case of parts not primed with lubricant the admissible storage temperature range corresponds to the operating temperature range (see Technical data).
- In case of parts primed with lubricant the admissible storage temperature range is:
  - min. + 5 °C
  - max. +35 °C

## 6. Installation

### 6.1 General information

Only qualified technical personnel may install the products described in these Instructions.

During assembly pay attention to the following:

- All components used must be designed according to the maximum operating pressure and the maximum respectively minimum operating temperature.
  - Other units must not be damaged by the assembly.
  - The product must not be installed within the range of moving parts.
  - The product must be installed at an adequate distance from sources of heat and coldness.
  - Adhere to safety distances and legal prescriptions on assembly and prevention of accidents.
  - Observe prescriptions in the Technical data (chapter 4) regarding the installation position.
- In case of oscillating movements the lubrication pinion must be mounted as close to the friction point as possible. It must be ensured that the lubricant applied reaches the friction points.
  - Installation of the lubrication pinion should take place at the expected operating temperature. Strong deviations may result in an increased or reduced contact pressure outside of the permitted range. Therefore, in case of affected machines or vehicles (summer/ winter operation) check and, if necessary, adapt the contact pressure.

### 6.2 Place of installation

Protect the product against humidity, dust and vibrations and install it in an easily accessible position to facilitate other installation and maintenance works.

### 6.3 Fastening material

Fastening of the lubrication pinion is done by means of:

4 x screw M10

4 x hex nut M10

4 x washer 10

Choose the screw length according to the actual mounting situation.

Screw strength class at least 8.8 or higher. Tightening torques corresponding to screw size and strength class. Indications, see respective technical literature.

## 6.4 Installation of the lubrication pinion



Mount the lubrication pinion centrally and with as little distance as possible to the object to be lubricated. Observe parallelism of the axes. Deviation  $1^\circ$  max.

- Close the unneeded connector G1/8 with a closure cap.



If the component to be lubricated cannot be rotated by hand, start by priming the lubrication pinion as described in chapter 6.5.

- Press lubrication pinion (1) by hand against the object to be lubricated, When doing so one tooth must be fully engaged - as shown. Mark this position (5), e. g. with a scribe, on the rear edge of the bracket.
- Mark and drill mounting bores accordingly. Make sure that the lubrication pinion can still be shifted in the oblong holes in longitudinal direction.

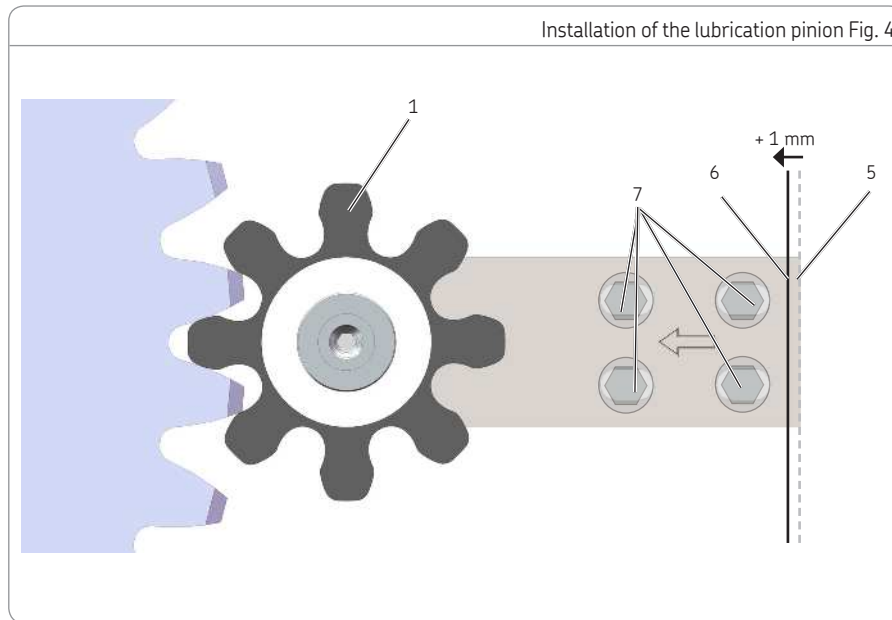

- Again press the lubrication pinion lightly by hand against the component to be lubricated. Then push the lubrication pinion forward by 1 mm into the final mounting position (6).
- Tighten the 4 fastening screws (7) to fix the lubrication pinion (1) and connect the supply line.

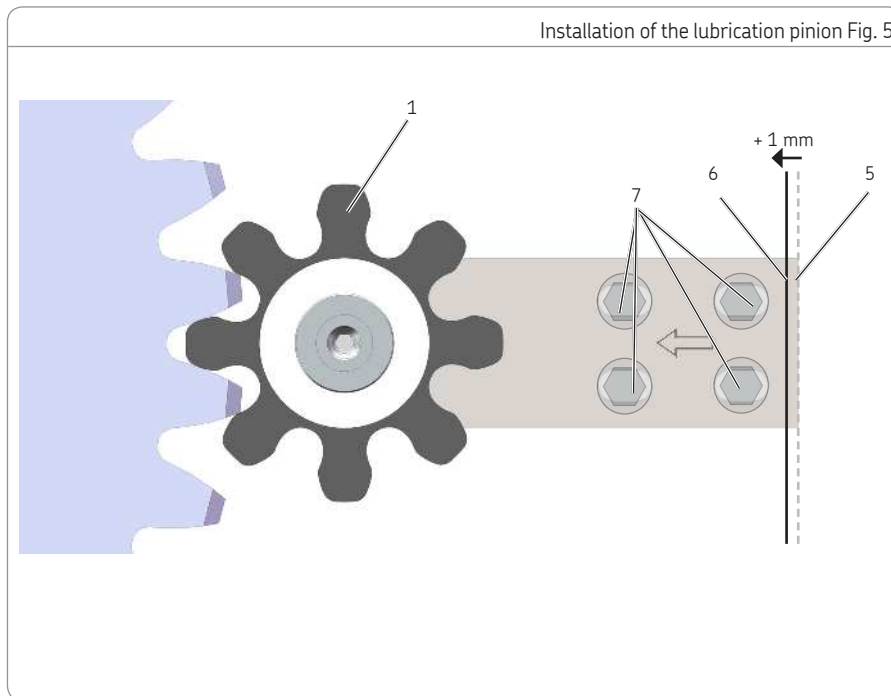



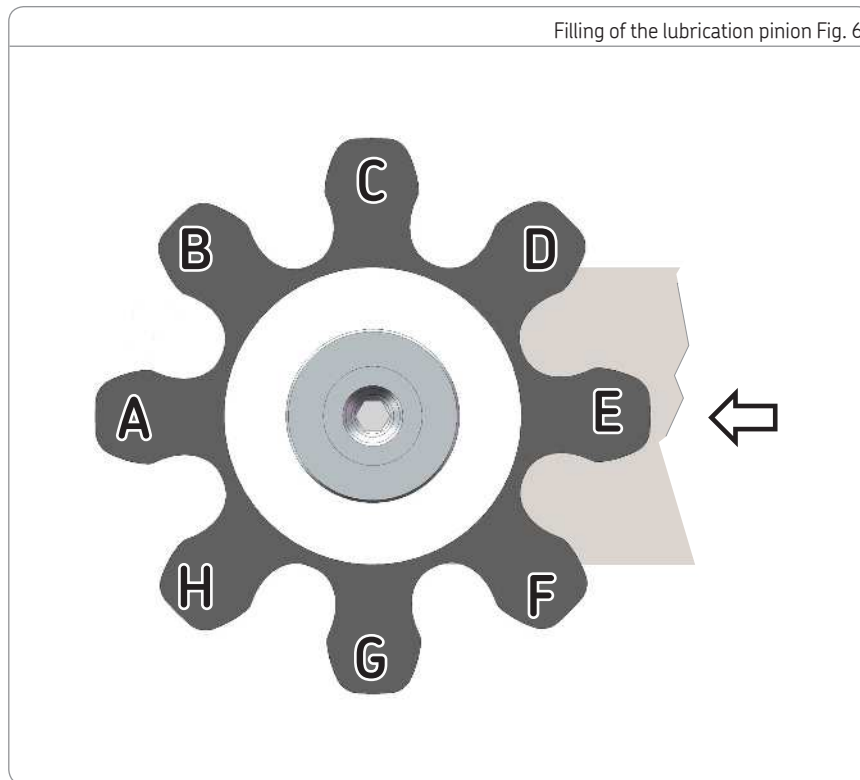

### 6.5 Filling of the lubrication pinion

- Fill the lubrication pinion with appropriate pump until lubricant leaks from the active lubrication channel (A). When doing so, observe the technical data (chapter 4) regarding the maximum admissible volumetric flow rate and the maximum admissible pressure. Turn the lubrication pinion one lubrication duct ahead and repeat procedure until all lubrication ducts are filled.



## 6.6 Lubrication line connection

 <b>CAUTION</b>
 <p><b>Risk of falling</b> Exercise care when dealing with lubricants. Bind and remove spilled or leaked lubricants immediately.</p>



Connect lubrication lines in such way that no forces are transferred to the product (tension-free connection).

All components of the centralized lubrication system must be laid out for:

- the maximum arising operating pressure
- the operating temperature range
- the output volume and the lubricant to be supplied

Observe the following installation instructions for safe and smooth operation.

- Use clean components and primed lubrication lines only.
- The main lubrication line should be laid preferably rising with a possibility to vent it at its highest point. Lubrication lines shall generally be laid in such way that there can never be created air pockets at any point.
- Possibly mount the lubricant metering devices at the end of the main lubrication line in such way that the outlets of the lubricant metering devices show upwards.
- If lubricant metering devices have to be mounted below the main lubrication line, then this should not be done at the end of the main lubrication line.
- The lubricant flow should not be impeded by the installation of sharp elbows, angle valves, gaskets protruding to the inside, or cross-section changes (big to small). Provide unavoidable changes of the cross sections in the lubrication lines with as smooth transitions as possible.

## 7. Initial start-up

In order to warrant safety and function, a person assigned by the operator must carry out the following inspections. Immediately eliminate detected deficiencies. Deficiencies may be remedied by an authorized and qualified specialist only.

Start-up check list

### 7.1 Inspections prior to initial start-up

YES NO

Mechanical connection of the lubrication pinion carried out correctly (track alignment, central orientation, contact pressure, one connector G1/8 closed, lubrication pinion primed)

The lubrication line is mounted correctly

No visible damages, deformations or cracks

Any dismantled protection and monitoring equipment has been reassembled and checked for correct function

No contamination on the lubrication pinion or the component to be lubricated Particularly metallic particles (such as chips, abrasions, casting residues) and mineral particles (e. g. stones, rubble, breakage of glass, etc.) must be removed carefully and regularly.

Start-up of the completely and correctly mounted lubrication pinion is effected by activating the superior machine / vehicle, in which the lubrication pinion has been installed.

### 7.2 Inspections during initial start-up

No unusual noises or vibrations

No unwanted escape of lubricant from connections (leakages).

Lubrication pattern on the component to be lubricated is correct (see chapter 3.1)

7

## 8. Operation

SKF products operate automatically to the greatest possible extent.

Basically, activities during standard operation are limited to the controlling:

- the lubrication pattern (see chapter Lubrication pattern)
- the pump filling level and the timely re-filling of lubricant (see Instructions of the pump).

## 9. Cleaning



### WARNING

#### Personal injury and material damage

When using steam-jet devices or high-pressure cleaners keep a minimum distance of 30 cm to the lubrication pinion. Performance of cleaning, required personal protective equipment, cleaning agents and devices following the valid operational regulations of the operator. If cleaning agents are used, observe the safety data sheet provided by the cleaning agent manufacturer and the notes regarding material compatibility.

### 9.1 Cleaning agents

Cleaning agents compatible with the material may be used only.



Thoroughly remove residues of cleaning agents from the product and rinse off with clear water.

### 9.2 Exterior cleaning

- Mark and secure wet areas.
- Keep unauthorized persons away
- Thorough cleaning of all outer surfaces with a damp cloth.



Make sure to keep the reservoir closed during the cleaning procedure.

### 9.3 Interior cleaning

Normally, interior cleaning is not required. Should incorrect or contaminated lubricant have been filled, inside cleaning of the product will be required.

To do so, contact the SKF Customer Service.

## 10. Maintenance

Regular and appropriate maintenance is a prerequisite to detect and clear faults in time. The specific timelines have to be determined, verified at regular intervals and adapted, if necessary, by the operator based on the operating conditions. If needed, copy the table for regular maintenance activities.

Maintenance check list		
Activity to be done	YES	NO
Mechanical connection of the lubrication pinion carried out correctly (track alignment, central orientation, contact pressure, etc.)	<input type="checkbox"/>	<input type="checkbox"/>
The lubrication line is mounted correctly No unwanted escape of lubricant from tubes and fittings	<input type="checkbox"/>	<input type="checkbox"/>
No visible damages, deformations or cracks	<input type="checkbox"/>	<input type="checkbox"/>
Any dismantled protection and monitoring equipment of the superordinate machine has been reassembled and checked for correct function	<input type="checkbox"/>	<input type="checkbox"/>
No contamination on the lubrication pinion or the component to be lubricated Particularly metallic particles (such as chips, abrasions, casting residues) and mineral particles (e. g. stones, rubble, breakage of glass, etc.) must be removed carefully and regularly.	<input type="checkbox"/>	<input type="checkbox"/>
No unusual noises or vibrations	<input type="checkbox"/>	<input type="checkbox"/>
Lubrication pattern on the component to be lubricated is correct (see chapter 3.1)	<input type="checkbox"/>	<input type="checkbox"/>

## 11. Troubleshooting

Fault table 1

Fault	Possible cause	Remedy
The lubrication pinion does not apply any lubricant	<ul style="list-style-type: none"> <li>○ Failure of the centralized lubrication system or the supply pump</li> </ul>	<ul style="list-style-type: none"> <li>○ Check the lubricant supply. Perhaps lubricant leaking from the pressure control valve of the lubrication pump (see documentation of the centralized lubrication system or pump)</li> </ul>
Incomplete lubricant application by the lubrication pinion (faulty lubrication pattern)	<ul style="list-style-type: none"> <li>○ Wrong orientation of the lubrication pinion</li> <li>○ Wrong positioning of the lubrication pinion on the component to be lubricated</li> <li>○ Output volume or lubrication interval of the lubrication pump does not suit the requirement</li> </ul>	<ul style="list-style-type: none"> <li>○ Check track alignment and re-align, if necessary.</li> <li>○ Check positioning of the lubrication pinion on the tooth wheel and track alignment</li> <li>○ Adapt the output volume and, if applicable, the lubrication interval to the requirement</li> </ul>

In addition to the indications regarding troubleshooting stated here, observe all indications regarding troubleshooting stated in the pump instructions. If the fault cannot be determined and remedied, please contact our Customer Service.

## 12. Repairs

There are no parts to be repaired by the operator. In case of a defect make sure to replace the entire product. Excepted from this are the spare parts mentioned in these instructions. They may be used as a replacement for defective identical components.



The work described should possibly be done at room temperature. At low temperatures the work may be subject to restrictions.



## 13. Shutdown and disposal

### 13.1 Temporary shutdown

Temporarily shut the system down by:

- Switching off the superior machine

### 13.2 Final shutdown and disassembly

The final shutdown and disassembly of the product must be planned and carried out by the operator in a professional manner and in compliance with all regulations to be observed.

### 13.3 Disposal

#### Countries within the European Union

Disposal should be avoided or minimized wherever possible. Disposal of products contaminated with lubricant must be effected via licensed waste disposal contractor in accordance with environmental requirements and waste disposal regulations as well as local authority requirements.



The specific classification of the waste is in the waste producer's responsibility, as the European Waste Catalogue provides different waste disposal codes for the same type of waste but of different origin.

Parts made of plastic or metal can be disposed of with the commercial waste.



#### Countries outside the European Union

The disposal has to be done according to the valid national regulations and laws of the country where the product is used.

## 14. Spare parts

Illustrations of the spare parts, see chapter Tightening torques

Code	Designation	Corrosion protection class	Order number
H	Closure screw	C5-M-L	226-14160-3
A	Push-in type fitting Ø 6	C3-L	456-004-VS
		C5-M-L	226-14111-1
B	Elbow tube fitting 90° Ø 6	C5-M-L	226-13756-9
C	Straight tube fitting E02 Ø 6	C3-L	471-006-192
		C5-M-L	223-13658-2
D	Straight tube fitting E02 Ø 8	C3-L	223-10814-2
		C5-M-L	408-423W-S3
E	Straight tube fitting E02 Ø 10	C3-L	223-13621-9
		C5-M-L	223-13658-8
F	Adapter G1/8 to G1/4	C3-L	2230-00000032
		C5-M-L	2230-00000033
G	Adapter G1/8 to G3/8	C3-L	2230-00000034
		C5-M-L	2230-00000035

## Notes

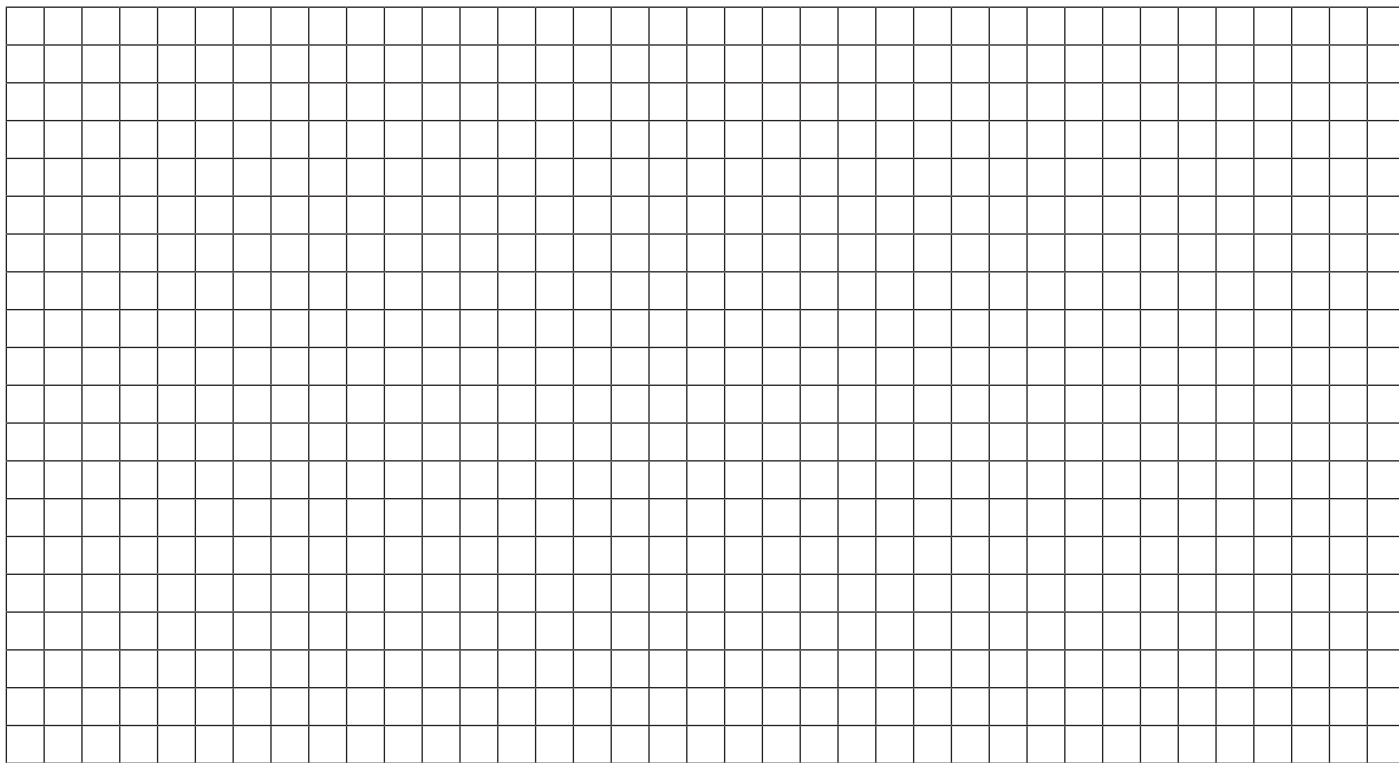

SKF Lubrication Systems Germany GmbH  
Walldorf Facilities  
Heinrich-Hertz-Str. 2-8  
DE - 69190 Walldorf  
Phone: +49 (0) 6227 33-0  
Fax: +49 (0) 6227 33-259  
e-mail: [Lubrication-germany@skf.com](mailto:Lubrication-germany@skf.com)  
[www.skf.com/lubrication](http://www.skf.com/lubrication)

951-231-003-EN  
Version 03  
2018/01/15

